

# COMSOL Multiphysics

Application Programming Guide

# Application Programming Guide

© 1998–2021 COMSOL

Protected by patents listed on [www.comsol.com/patents](http://www.comsol.com/patents), or see Help>About COMSOL Multiphysics on the File menu in the COMSOL Desktop for a less detailed lists of U.S. Patents that may apply. Patents pending.

This Documentation and the Programs described herein are furnished under the COMSOL Software License Agreement ([www.comsol.com/comsol-license-agreement](http://www.comsol.com/comsol-license-agreement)) and may be used or copied only under the terms of the license agreement.

COMSOL, the COMSOL logo, COMSOL Multiphysics, COMSOL Desktop, COMSOL Compiler, COMSOL Server, and LiveLink are either registered trademarks or trademarks of COMSOL AB. All other trademarks are the property of their respective owners, and COMSOL AB and its subsidiaries and products are not affiliated with, endorsed by, sponsored by, or supported by those trademark owners. For a list of such trademark owners, see [www.comsol.com/trademarks](http://www.comsol.com/trademarks).

Version: COMSOL 6.0

## Contact Information

Visit the Contact COMSOL page at [www.comsol.com/contact](http://www.comsol.com/contact) to submit general inquiries or search for an address and phone number. You can also visit the Worldwide Sales Offices page at [www.comsol.com/contact/offices](http://www.comsol.com/contact/offices) for address and contact information.

If you need to contact Support, an online request form is located at the COMSOL Access page at [www.comsol.com/support/case](http://www.comsol.com/support/case). Other useful links include:

- Support Center: [www.comsol.com/support](http://www.comsol.com/support)
- Product Download: [www.comsol.com/product-download](http://www.comsol.com/product-download)
- Product Updates: [www.comsol.com/support/updates](http://www.comsol.com/support/updates)
- COMSOL Blog: [www.comsol.com/blogs](http://www.comsol.com/blogs)
- Discussion Forum: [www.comsol.com/forum](http://www.comsol.com/forum)
- Events: [www.comsol.com/events](http://www.comsol.com/events)
- COMSOL Video Gallery: [www.comsol.com/videos](http://www.comsol.com/videos)
- Support Knowledge Base: [www.comsol.com/support/knowledgebase](http://www.comsol.com/support/knowledgebase)

Part number: CM020012

# Contents

---

Introduction . . . . .	7
Syntax Primer . . . . .	8
Data Types. . . . .	8
Declarations. . . . .	14
Built-in Elementary Math Functions. . . . .	15
Control Flow Statements. . . . .	16
Important Programming Tools. . . . .	19
Ctrl+Space for Code Completion . . . . .	19
Recording Code . . . . .	21
Methods Called from the Model Builder . . . . .	24
Global Methods, Form Methods, and Local Methods . . . . .	24
Method Names. . . . .	25
Introduction to the Model Object. . . . .	26
Model Object Tags. . . . .	26
Creating a Model Object. . . . .	28
Creating Model Components and Model Object Nodes . . . . .	29
Get and Set Methods for Accessing Properties . . . . .	29
Parameters and Variables. . . . .	35
Unary and Binary Operators in the Model Object. . . . .	37
Geometry. . . . .	38
Mesh. . . . .	39
Physics . . . . .	40
Material. . . . .	42
Study. . . . .	44
Results . . . . .	48

Multiphysics . . . . .	50
Working with Model Objects . . . . .	51
The Model Object Class Structure. . . . .	53
The Application Object . . . . .	55
Shortcuts . . . . .	55
Accessing the Application Object. . . . .	57
The Name of User Interface Components . . . . .	57
Important Classes . . . . .	57
Get and Set Methods for the Color of a Form Object . . . . .	58
General Properties . . . . .	59
The Main Application Methods. . . . .	61
Main Window . . . . .	61
Form. . . . .	62
Form Object . . . . .	64
Item . . . . .	86
Data Source. . . . .	87
AppEvent Class . . . . .	91
Method Class . . . . .	93
Form, Form Object, and Item List Methods . . . . .	93
The Built-in Method Library for the Application Builder. . . . .	95
Model Utility Methods . . . . .	95
License Methods. . . . .	97
File Methods . . . . .	100
Operating System Methods. . . . .	107
Email Methods. . . . .	110
Email Class Methods. . . . .	110
GUI-Related Methods . . . . .	114
GUI Command Methods. . . . .	125

Debug Methods .....	126
Methods for External C Libraries .....	126
Progress Methods .....	128
Date and Time Methods .....	134
Conversion Methods .....	137
Array Methods .....	139
String Methods .....	147
Collection Methods .....	148
Model Builder Methods for Use in Add-Ins. ....	151
Programming Examples .....	153
Running the Examples .....	153
Visualization Without Solution Data: Grid Datasets. ....	153
Visualization of Points, Curves, and Surfaces .....	155
Reading and Writing Data to File .....	165
Converting Interpolation Curve Data. ....	188
Plotting Points on a Parametric Surface .....	190
Using Selections for Editing Geometry Objects .....	191
Recursion and Recursively Defined Geometry Objects. ...	196
Mesh Information and Statistics. ....	200
Accessing Higher-Order Finite Element Nodes .....	201
Accessing System Matrices and Vectors. ....	203
Data Validation .....	208
Using Selections in Add-Ins .....	220
Using Built-In Methods from an External Java Library. ....	226
Measuring the Java Heap Space Memory. ....	227
Time-Limited and Hardware-Locked Applications. ....	227



# Introduction

---

This book is a guide to writing code for COMSOL<sup>®</sup> models and applications using the Method Editor. The Method Editor is an important part of the Application Builder and is available in the COMSOL Desktop<sup>®</sup> environment in the Windows<sup>®</sup> version of COMSOL Multiphysics. For an introduction to using the Application Builder and its Form editor and Method Editor, see the book *Introduction to Application Builder*.

Writing a method is needed when an action is not already available in the standard run commands associated with functionality in the model tree nodes of the Model Builder. A method may, for example, contain loops, process inputs and outputs, and send messages and alerts to the user of the application.

In the Model Builder, the model tree is a graphical representation of the data structure that represents a model. This data structure is called the model object and stores the state of the underlying COMSOL Multiphysics model that is embedded in an application.

The contents of the application tree in the Application Builder is accessed through the application object, which is an important part of the model object. You can write code using the Method Editor to directly access and change the user interface of a running application, for example, to update button text, icons, colors, and fonts.

In the COMSOL Multiphysics environment, you use the Java<sup>®</sup> programming language to write methods, which means that you can utilize the extensive collection of Java<sup>®</sup> libraries. In addition to the Java<sup>®</sup> libraries, the Application Builder includes a built-in library for building applications and modifying the model object. A number of tools and resources are available to help you automatically create code for methods. For more information on autogeneration of code, see the book *Introduction to Application Builder*.

This book assumes no prior knowledge of the Java<sup>®</sup> programming language. However, some familiarity with a programming language is helpful.

# Syntax Primer

---

If you are not familiar with the Java<sup>®</sup> programming language, read this section to quickly get up to speed with its syntax. When creating applications, it is useful to know the basics of Java such as how to use the `if`, `for`, and `while` control statements. The more advanced aspects of Java will not be covered in this book. For more detail, see any dedicated book on Java programming or one of the many online resources. You can also learn a lot by reviewing the methods in the example applications available in the Application Libraries.

## Data Types

---

### PRIMITIVE DATA TYPES

Java contains eight primitive data types, listed in the table below.

DATA TYPE	DESCRIPTION	NUMBER OF BYTES	EXAMPLE
<code>byte</code>	Integer between -127 and 128	1	<code>byte b=33;</code>
<code>char</code>	Unicode character; integer between 0 and 65535 (0 and $2^{16}-1$ )	2	<code>char c='a';</code> <code>char c=97;</code>
<code>short</code>	Integer between -32768 and 32767 ( $-2^{15}-1$ and $2^{15}-1$ )	2	<code>short s=-1025;</code>
<code>int</code>	Integer between $-2^{31}$ and $2^{31}-1$	4	<code>int i=15;</code>
<code>long</code>	Integer between $-2^{63}$ and $2^{63}-1$	8	<code>long l=15;</code>
<code>float</code>	32-bit floating point number	4	<code>float f=4.67f;</code>
<code>double</code>	64-bit floating point number	8	<code>double d=4.67;</code>
<code>boolean</code>	Boolean with values <code>false</code> or <code>true</code>	N/A	<code>boolean b=true;</code>

Other data types such as strings are classes, which are also referred to as composite data types.

In methods, you can use any<sup>5</sup> of the primitive or composite data types available in Java and the Java libraries. Many of the Application Builder built-in methods make use of primitive or composite data types. For example, the `timeStamp()` method provides a long integer as its output.

### ASSIGNMENTS AND LITERALS

A few examples of using literals in assignments are:



```
int i=5; // initialize i and assign the value 5
double d=5.0; // initialize d and assign the value 5.0
boolean b=true; // initialize b and assign the value true
```

The constants 5, 5.0, and true are literals. Java distinguishes between the literals 5 and 5.0, where 5 is an integer and 5.0 is a double (or float).

## UNARY AND BINARY OPERATORS IN METHODS (JAVA SYNTAX)

You can perform calculations and operations using primitive data types just like with many other programming languages. The table below describes some of the most common unary and binary operators used in Java code.

PRECEDENCE LEVEL	SYMBOL	DESCRIPTION
1	++ --	unary: postfix addition and subtraction
2	++ -- + - !	unary: addition, subtraction, positive sign, negative sign, logical not
3	* / %	binary: multiplication, division, modulus
4	+ -	binary: addition, subtraction
5	!	Logical NOT
6	< <= > >=	comparisons: less than, less than or equal, greater than, greater than or equal
7	== !=	comparisons: equal, not equal
8	&&	binary: logical AND
9		binary: logical OR
10	?:	conditional ternary
11	= += -= *= /= %= >>= <<= &= ^=  =	assignments
12	,	element separator in lists

## TYPE CONVERSIONS AND TYPE CASTING

When programming in Java, conversion between data types is automatic in many cases. For example, the following lines convert from an integer to a double:

```
int i; // initialize i
double d; //initialize d
i=41;
d=i; // the integer i is assigned to the double d and d is 41.0
```

However, the opposite will not work automatically (you will get a compilation error). Instead you can use explicit type casting as follows:

```

int i; // initialize i
double d; //initialize d
d=41.0;
i=(int) d; // the double d is assigned to the integer i and i is 41

```

You can convert between integers and doubles within arithmetic statements in various ways, however you will need to keep track of when the automatic type conversions are made. For example:

```

int i; // initialize i
double d; //initialize d
i=41;
d=14/i; // d is 0

```

In the last line, 14 is seen as an integer literal and the automatic conversion to a double is happening after the integer division 14/41, which results in 0.

Compare with:

```

int i; // initialize i
double d; //initialize d
i=41;
d=14.0/i; // d is 0.3414...

```

In the last line, 14.0 is seen as a double literal and the automatic conversion to a double is happening before the division and is equivalent to 14.0/41.0.

You can take charge over the type conversions with explicit casting by using the syntax (int) or (double):

```

int i; // initialize i
double d,e; //initialize d and e
i=41;
d=((int) 14.0)/i; // d is 0
e=14/((double) i); // e is 0.3414...

```

## STRINGS AND JAVA OBJECTS

The `String` data type is a Java object. This is an example of how to declare a string variable:

```
String a="string A";
```

When declaring a string variable, the first letter of the data type is capitalized. This is a convention for composite data types (or object-oriented classes).

After you have declared a string variable, a number of methods are automatically made available that can operate on the string in various ways. Two such methods are `concat` and `equals` as described below, but there are many more methods available in the `String` class. See the online Java documentation for more information.

### *Concatenating Strings*

To concatenate strings, you can use the method `concat` as follows:

```
String a = "string A";  
String b = " and string B";  
a.concat(b);
```

The resulting string `a` is "string A and string B". From an object-oriented perspective, the variable `a` is an instance of an object of the class `String`. The method `concat` is defined in the `String` class and available using the `a.concat()` syntax.

Alternatively, you can use the `+` operator as follows:

```
a = a + b;
```

which is equivalent to:

```
a = "string A" + " and string B";
```

and equivalent to:

```
a = "string A" + " " + "and string B";
```

where the middle string is a string with a single whitespace character.

### *Comparing Strings*

Comparing string values in Java is done with the `equals` method and not with the `==` operator. This is due to the fact that the `==` operator compares whether the strings are the same when viewed as class objects and does not consider their values. The code below demonstrates string comparisons:

```
boolean streq = false;  
String a = "string A";  
String b = "string B";  
streq = a.equals(b);  
// In this case streq == false  
  
streq = (a == b);  
// In this case streq == false  
  
b = "string A";  
streq = a.equals(b);  
// In this case streq == true
```

### *Special Characters*

If you would like to store, for example, a double quotation mark or a new line character in a string you need to use special character syntax preceded by a backslash (`\`). The table below summarizes some of the most important special characters.

SPECIAL CHARACTER	DESCRIPTION
<code>\'</code>	Single quotation mark
<code>\"</code>	Double quotation mark

SPECIAL CHARACTER	DESCRIPTION
\\	Backslash
\t	Tab
\b	Backspace
\r	Carriage return
\f	Form feed
\n	Newline

Note that in Windows the new line character is the composite `\r\n` whereas in Linux and macOS `\n` is used.

The example below shows how to create a string in Windows that you later on intend to write to file and that consists of several lines.

```
String contents = "# Created by me\r\n"
                +"# Version 1.0 of this file format \r\n"
                +"# Body follows\r\n"
                +"0 1 \r\n"
                +"2 3\r\n"
                +"4 5\r\n";
```

The string is here broken up into several lines in the code for readability. However, the above is equivalent to the following:

```
String contents = "# Created by me\r\n# Version 1.0 of this file format \r\n#
Body follows\r\n0 1 \r\n2 3\r\n4 5\r\n";
```

which is clearly less readable.

## ARRAYS

In the application tree, the **Declarations** node directly supports 1D and 2D arrays of type string (`String`), integer (`int`), Boolean (`boolean`), or double (`double`). A 1D array may be referred to as a vector and a 2D array referred to as a matrix, provided that the array is rectangular. A nonrectangular array is called jagged or ragged. In methods, you can define higher-dimensional arrays as well as arrays of data types other than string, integer, Boolean, or double.

### *1D Arrays*

If you choose not to use the **Declarations** node to declare an array, then you can use the following syntax in a method:

```
double dv[] = new double[12];
```

This declares a double array of length 12.

The previous line is equivalent to the following two lines:

```
double dv[];
dv = new double[12];
```

When a double vector has been declared in this way, the value of each element in the array will be zero.

To access elements in an array you use the following syntax:

```
double e;  
e = dv[3]; // e is 0.0
```

Arrays are indexed starting from 0. This means that `dv[0]` is the first element of the array in the examples above, and `dv[11]` is the last element.

You can simultaneously declare and initialize the values of an array by using curly braces:

```
double dv[] = {4.1, 3.2, 2.93, 1.3, 1.52};
```

In a similar way you can create an array of strings as follows:

```
String sv[] = {"Alice", "Bob", "Charles", "David", "Emma"};
```

## 2D Arrays

2D rectangular arrays can be declared as follows:

```
double dm[][] = new double[2][3];
```

This corresponds to a matrix of doubles with 2 rows and 3 columns. The row index comes first.

You can simultaneously declare and initialize a 2D array as follows:

```
double dm[][] = {{1.32, 2.11, 3.43}, {4.14, 5.16, 6.12}};
```

where the value of, for example, `dm[1][0]` is 4.14. This array is a matrix since it is rectangular (it has same number of columns for each row). You can declare a ragged array as follows:

```
double dm[][] = {{1.32, 2.11}, {4.14, 5.16, 6.12, 3.43}};
```

where the value of, for example, `dm[1][3]` is 3.43.

## Copying Arrays

For copying arrays, the following code:

```
for (int i1 = 0; i1 <= 11; i1++) {  
    for (int i2 = 0; i2 <= 2; i2++) {  
        input_array[i1][i2] = init_input_array[i1][i2];  
    }  
}
```

is not equivalent to the line:

```
input_array = init_input_array;
```

since the last line will only copy by reference.

Instead, you can use the `copy` method as follows:

```
input_table = copy(init_input_table);
```

which allocates a new array and then copies the values.

## Declarations

---

Variables defined in the **Declarations** node in the application tree are directly available as global variables in a method and need no further declarations.

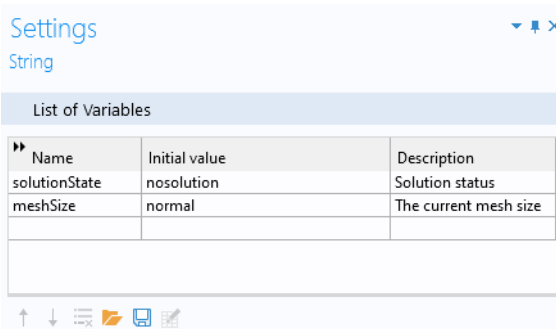
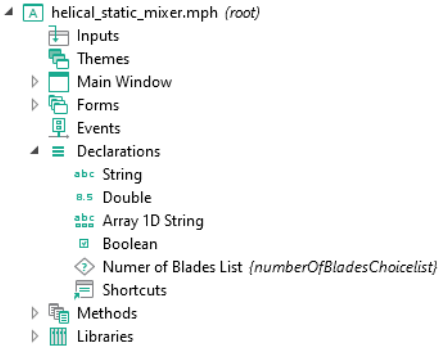

Variables declared in methods will have local scope unless you specify otherwise. The **Declarations** node directly supports integers (`int`), doubles (`double`), and Booleans (`boolean`). In addition, strings are supported (see “Strings and Java Objects” on page 10). In the **Declarations** node, variables can be scalars, 1D arrays, and 2D arrays.

To simplify referencing form objects as well as menu, ribbon, and toolbar items by name, you can create shortcuts with a custom name. These names are available in the **Declarations** node under **Shortcuts**. They are directly available in methods along with the other global variables defined under **Declarations**. For more information on shortcuts, see “Shortcuts” on page 55.

## FORM DECLARATIONS

Variables can also be defined as **Form Declarations** under each respective form node in the application tree.

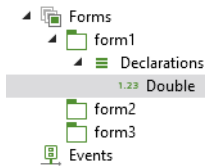

Form declarations can be of the types **Scalar**, **Array 1D**, **Array 2D** and **Choice List**. Global declarations are exposed to all user-interface components of the application whereas form declarations are only exposed to the form that they are defined in and the form objects within that form. Form declarations are used to limit the scope of variables and thereby logically separate the different parts of an application.

## Built-in Elementary Math Functions

---

Elementary math functions for use in methods are available in the Java math library. Some examples:

```
double a = Math.PI;           // the mathematical constant pi
double b = Math.sin(3*a);    // trigonometric sine function
double c = Math.cos(4*a);    // trigonometric cosine function
double d = Math.random();    // random number uniformly distributed in [0,1)
double e = Math.exp(2*a);    // exponential function
double f = Math.log(1+e);    // natural base e logarithm
double g = Math.pow(10,3);   // power function
double h = Math.log10(2.5);  // base 10 logarithm
double k = Math.sqrt(81.0);  // square root
```

There are several more math functions available in the Java math library. For additional information, see any Java book or online resource.

## Control Flow Statements

---

Java supports the usual control flow statements `if-else`, `for`, and `while`. You can use the **Language Elements** tool to insert template code corresponding to a number of control flow, of or block, statements.

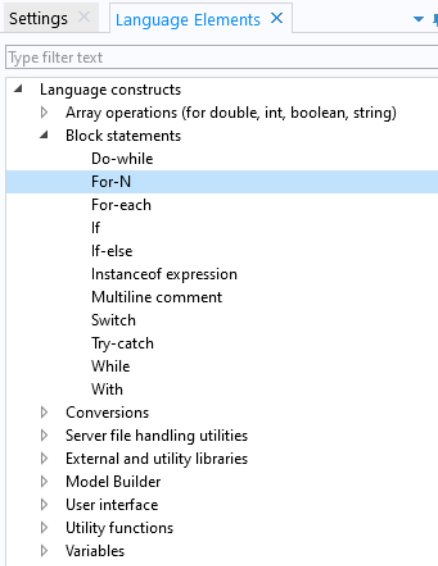

The following examples illustrate some of the most common uses of control flow statements.

### THE IF-ELSE STATEMENT

This is an example of a general `if-else` statement:

```
if (a < b) {
    alert("Value too small.");
} else {
    alert("Value is just right.");
}
```

Between curly braces `{}` you can include multiple lines of code, each terminated with a semicolon. If you only need one line of code, such as in the example above, this shortened syntax is available:

```
if (a < b)
    alert("Value too small.");
else
    alert("Value is just right.");
```



## THE FOR STATEMENT

Java supports several different types of for statements. This example uses the perhaps most conventional syntax:

```
// Iterate i from 1 to N:
int N = 10;
for (int i = 1; i <= N; i++) {
    // Do something
}
```

An alternative syntax is shown in the example on page 64 where the loop is over all form objects in a list of form objects:

```
for (FormObject formObject : app.form("form1").formObject()) {
    if ("Button".equals(formObject.getType())) {
        formObject.set("enabled", false);
    }
}
```

where the local iteration variable looped over is `formObject` of the type, or class, `FormObject`. The collection of objects, in this case `app.form("form1").formObject()`, can be an array or other types of lists of objects. Using this syntax, the iteration variable loops over all entries in the collection, from start to finish. Another example can be found on page 94.

## THE WHILE STATEMENT

This example shows a while statement.

```
double t = 0, h = 0.1, tend = 10;
while(t < tend) {
    // do something with t
    t = t + h;
}
```

For a more advanced example of a while statement, see “Creating and Removing Model Tree Nodes” on page 42.

Note that Java also supports do-while statements.

## THE WITH STATEMENT

When writing methods in the Method Editor, in addition to the standard Java control flow statement, there is also an optional `with` statement that can be used to make Application Builder code more compact and easier to read (you enable this in **File>Preferences**). A simple example is shown below:

```
// Set the global parameter L to a fixed value
with(model.param());
    set("L", "10[cm]");
endwith();
```

The code above is equivalent to:

```
model.param().set("L", "10[cm]");
```

In this case using the `with` statement has limited value since just one parameter is assigned but for multiple assignments readability increases. See “Parameters and Variables” on page 35 for an example with multiple assignments.

Note that the `with` statement is only available when writing code in the Method Editor. It is not available when using the COMSOL API for use with Java<sup>®</sup>. You can turn off the use of `with` statements in the section for **Methods in Preferences**.

The method `descr` returns the variable description for the last parameter or variable in a `with` statement:

```
with(model.param());  
  set("L", "10[cm]");  
  String ds = descr("L");  
endwith();
```

Assuming that the parameter description of the parameter `L` is `Length`. The string `ds` will have the value `Length`.

## EXCEPTION HANDLING

An exception is an error that occurs at runtime. The Java<sup>®</sup> programming language has a sophisticated machinery for handling exceptions and each exception generates an object of an exception class. The most common way to handle exceptions is by using `try` and `catch`, as in the example below.

```
double d[][] = new double[2][15];  
try {  
  d = readMatrixFromFile("common:///my_file.txt");  
} catch (Exception e) {  
  error("Cannot find the file my_file.txt.");  
}
```

where an error dialog box is shown in case the file `my_file.txt` is not found in the application file folder `common`. See the Java<sup>®</sup> documentation for more information about using `try` and `catch`.

## Important Programming Tools

---

The Application Builder includes several tools for automatically generating code as well as debugging. These tools include code completion, **Record Method**, **Record Code**, **Convert to New Method**, **Editor Tools**, **Language Elements**, **Copy as Code to Clipboard**, **Call Stack**, and **Variables**, and are described in the book *Introduction to Application Builder*. These utilities allow you to quickly get up and running with programming tasks even if you are not familiar with the syntax.

The following sections describes two of the most important tools: code completion using Ctrl+Space and **Record Code**. Using these tools will make you more productive, for example, by allowing you to copy-paste or autogenerate blocks of code.

### Ctrl+Space for Code Completion

---

While typing code in the Method Editor, the Application Builder can provide suggestions for code completions. The list of possible completions are shown in a separate completion list that opens while typing. In some situations, detailed information appears in a separate window when an entry is selected in the list. Code completion can always be requested with the keyboard shortcut Ctrl+Space. Alternatively Ctrl+/  
 can be used to request code completion, which is useful if Ctrl+Space is in use by the Windows operating system such as for certain languages. When accessing parts of the model object, you will get a list of possible completions, as shown in the figure below:

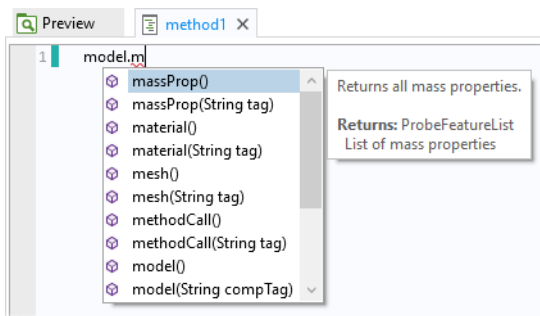

Select a completion by using the arrow keys to choose an entry in the list and double-click, or press the Tab or Enter key, to confirm the selection.

If the list is long, you can filter by typing the first few characters of the completion you are looking for.

For example, if you enter the first few characters of a variable or method name, and press Ctrl+Space, the possible completions are shown:

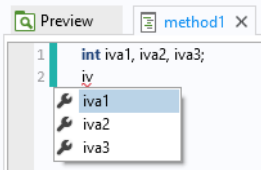

In the example above, only variables that match the string `iv` are shown. This example shows that variables local to the method also appear in the completion suggestions.

You can also use Ctrl+Space to learn about the syntax for the built-in methods that are not directly related to the model object. Type the name of the command and use Ctrl+Space to open a window with information on the various calling signatures available.

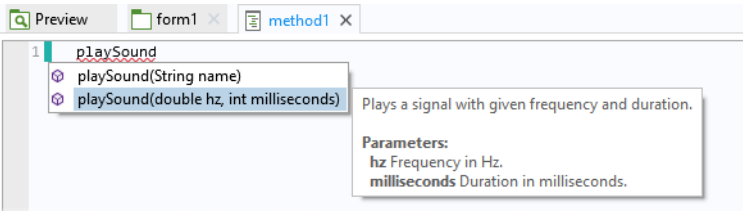

Additional information is also available in the form of tool tips that are displayed when hovering over the different parts of the code.

The Method Editor also supports code completion for properties, including listing the properties that are available for a given model object feature node, and providing a list of allowed values that are available for a given property.

The figure below shows an example of code completion for the mesh element size property, where a list of the allowed values for the predefined element sizes is presented.

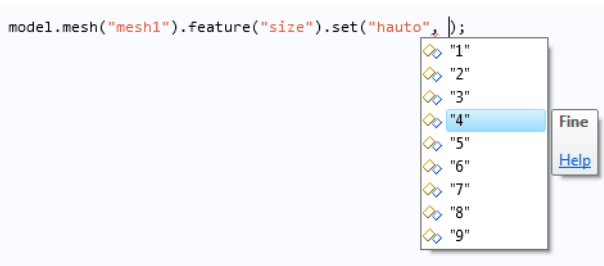

COMSOL Multiphysics and its add-on modules contain thousands of physics features that you can learn about by using, for example, **Record Code**, **Save as>Model File for Java**, and code completion. The figure below shows code completion for a particular feature in the **Electric Currents** interface.

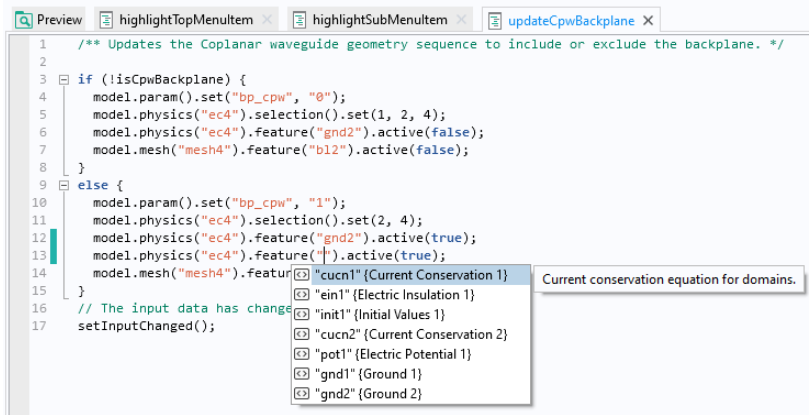

```

1  /** Updates the Coplanar waveguide geometry sequence to include or exclude the backplane. */
2
3  if (!isCpwBackplane) {
4      model.param().set("bp_cpw", "0");
5      model.physics("ec4").selection().set(1, 2, 4);
6      model.physics("ec4").feature("gnd2").active(false);
7      model.mesh("mesh4").feature("b12").active(false);
8  }
9  else {
10     model.param().set("bp_cpw", "1");
11     model.physics("ec4").selection().set(2, 4);
12     model.physics("ec4").feature("gnd2").active(true);
13     model.physics("ec4").feature("cucn1").active(true);
14     model.mesh("mesh4").feature("cucn1").active(true);
15 }
16 // The input data has changed
17 setInputChanged();

```

Current conservation equation for domains.

- cucn1 {Current Conservation 1}
- ein1 {Electric Insulation 1}
- init1 {Initial Values 1}
- cucn2 {Current Conservation 2}
- pot1 {Electric Potential 1}
- gnd1 {Ground 1}
- gnd2 {Ground 2}

## Recording Code

Click the **Record Code** button in the **Code** section of the Method Editor ribbon to record a sequence of operations that you perform using the model tree, as shown in the figure below.

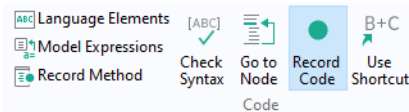

Certain operations in the application tree can also be recorded, for example, code that changes the color of a text label in a running application may be generated. To record a new method, click the **Record Method** button in the **Main** section of the **Home** tab.

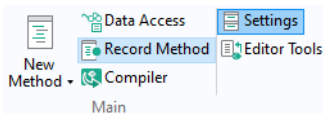

While recording code, the COMSOL Desktop windows are surrounded by a red frame:

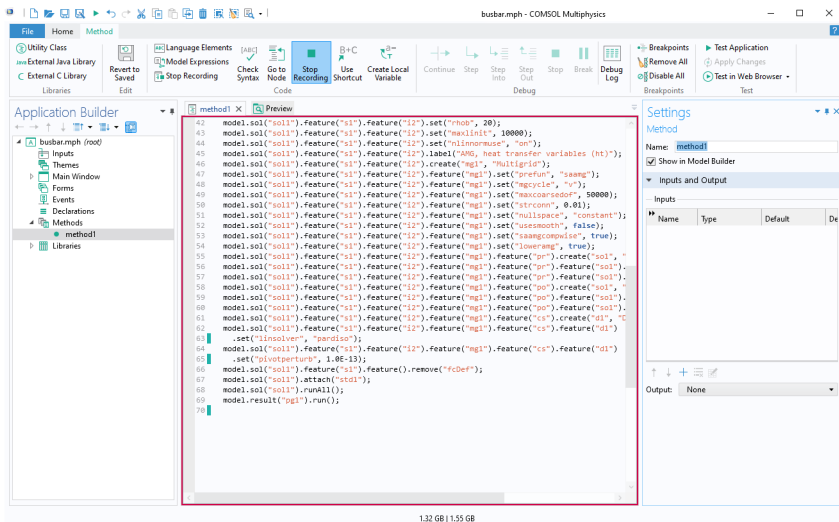
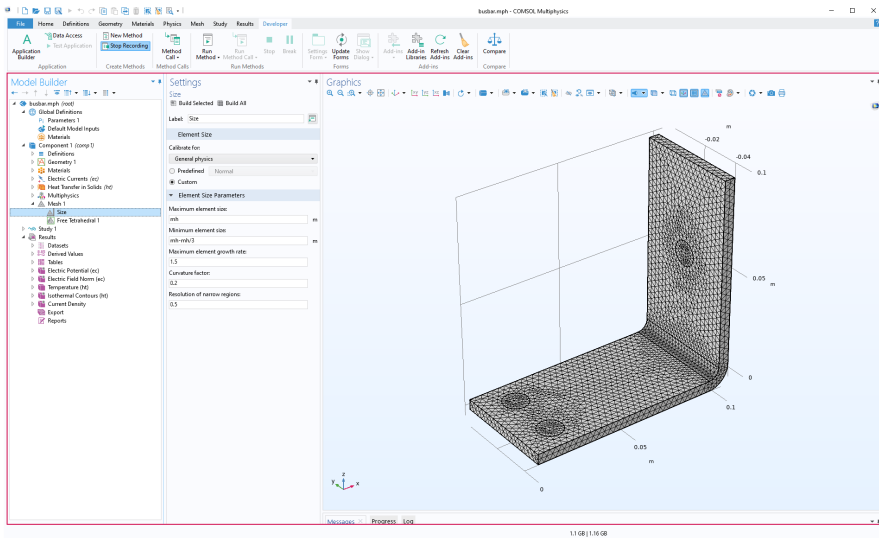

To stop recording code, click one of the **Stop Recording** buttons in the ribbon of either the Model Builder or the Application Builder.

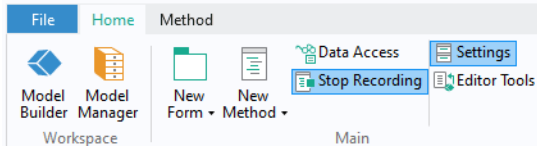

By using **Data Access**, you can set the values of the **Heat transfer coefficient** and the **External temperature** properties of the busbar tutorial model used in the books *Introduction to COMSOL Multiphysics* and *Introduction to Application Builder*.

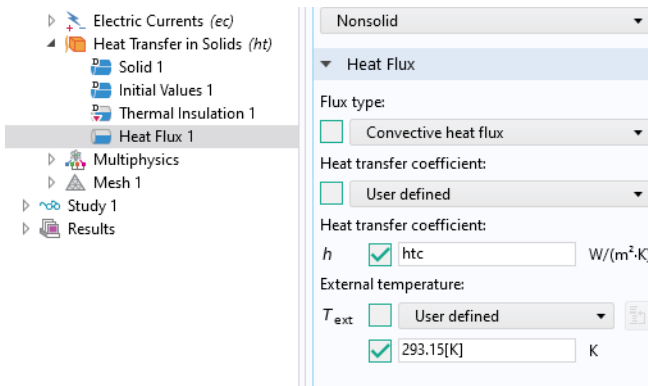

To generate similar code using **Record Code** (**Data Access** is not used when recording code), follow these steps:

- Create a simple application based on the busbar model (MPH file).
- In the Model Builder window, in the **Developer** tab, click **Record Method**, or with the Method Editor open, click **Record Code**.
- Change the value of the **Heat transfer coefficient** to 5.
- Change the value of the **External temperature** to 300[K].
- Click **Stop Recording**.
- If it is not already open, open the method with the recorded code.

The resulting code is listed below:

```
model.result("pg2").run();
model.component("comp1").physics("ht").feature("hf1").set("h", 5);
model.component("comp1").physics("ht").feature("hf1").set("Text",
"300[K]");
```

To generate code corresponding to changes to the application object, use **Record Code** or **Record Method**, then go to the Form editor, and, for example, change the appearance of a form object. The following code corresponds to changing the color of a text label from the default **Inherit** to **Blue**:

```
app.form("form1").formObject("textLabel1").set("foreground", "blue");
```

Built-in methods that changes the application object are only available when running applications and not when running methods from the Model Builder.

Use the tools for recording code to quickly learn how to interact with the model object or the application object. The autogenerated code shows you the names of properties, parameters, and variables. Use strings and string-number conversions to assign new parameter values in model properties. By using **Data Access** while recording, you can, for example, extract a parameter value using `get`, process its value in a method, and save it back into the model object using `set`. For more information on **Data Access**, see the *Introduction to Application Builder*.

## Methods Called from the Model Builder

---

Methods called from the Model Builder directly modify the model object represented by the Model Builder in the current session. Using methods in this way can be used to automate modeling tasks that consist of several manual steps. For example, in a model with multiple studies, you can record code for the process of first computing Study 1; then computing Study 2, which may be based on the solution from Study 1; and so on.

To customize the workflow in the Model Builder you can create an add-in based on methods by using a **Method Call** or a **Settings Form**. For an introductory example of using methods from the Model Builder and for information on how to create add-ins, see the *Introduction to Application Builder*.

## Global Methods, Form Methods, and Local Methods

---

There are global methods, form methods, and local methods. Global methods are displayed in the application tree and are accessible from all methods and form objects. Form methods are displayed in the application tree as child nodes to the form it belongs to. A local method is associated with a form object or event and can be opened from the corresponding **Settings** window.

Global methods are exposed to all components of the application whereas form methods are only exposed to the form that they are defined in and the form objects



within that form. You can use form methods to provide a logical separation of the different parts of an application.

## Method Names

---

A method name has to be a text string without spaces. The string can contain letters, numbers, and underscores. Java® programming language keywords cannot be used. The name must not begin by a number (this is also true for the name of a form object, variable, and method.)

A global method cannot have the same name as a form method and vice versa. In addition, the following names are reserved:

- `focusGained`
- `focusLost`
- `onActivate`
- `onClick`
- `onClose`
- `onDataChange`
- `onEvent`
- `onLoad`
- `onPickingChanged`
- `onStartup`
- `onShutdown`

# Introduction to the Model Object

---

The model object is the data structure that stores the state of the COMSOL Multiphysics model. The model object contents are reflected in the COMSOL Desktop user interface by the structure of the Model Builder and its model tree. The model object is associated with a large number of methods for setting up and running sequences of operations such as geometry sequences, mesh sequences, and study steps. As an alternative to using the Model Builder, you can write programs in the Method Editor that directly access and change the contents of the model object.

The model object methods are structured in a tree-like way, similar to the nodes in the model tree. The top-level methods just return references that support further methods. At a certain level the methods perform actions, such as adding data to the model object, performing computations, or returning data.

For a complete list of methods used to edit the model object, see the *Programming Reference Manual*. For an introduction to using the Model Builder, see the book *Introduction to COMSOL Multiphysics*.

The contents of the application tree in the Application Builder are accessed through the application object, which is an important part of the model object. You can write code using the Method Editor to alter, for example, button text, icons, colors, and fonts in the user interface of a running application.

This section gives an overview of the model object. The section “The Application Object” on page 55 gives an overview of the application object.

## Model Object Tags

---

In the model tree and when working with the model object from methods, tags are used as handles to different parts of the model object. These tags can also be made visible in the Model Builder by first clicking the Model Builder toolbar menu **Model Tree Node Text** and then choosing **Tag**, as shown in the figure below.

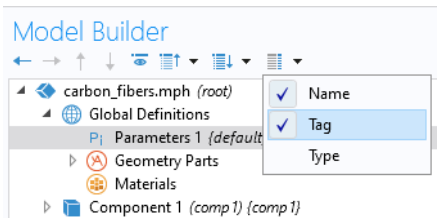

The figures below show an example of a model tree without tags shown in the left figure and with tags shown in the right figure.

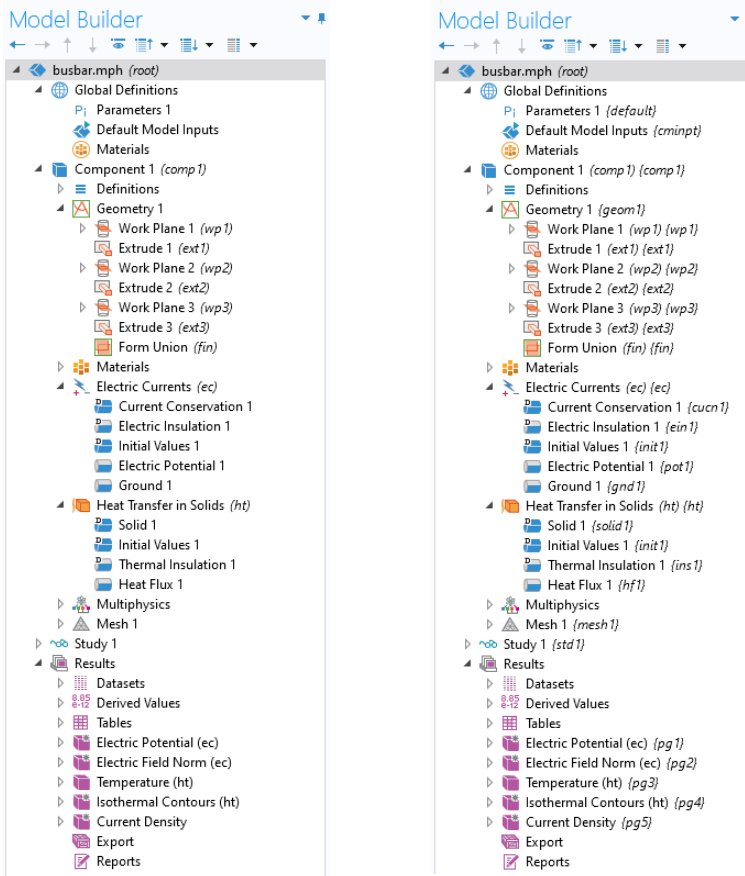

In code, the tags are referenced using double quotes. For example, in the following line

```
model.geom("geom1").create("r1", "Rectangle");
```

geom1 is a tag for a geometry object and r1 is a tag for a rectangle object. The following sections contain multiple examples of using tags to create and edit parts of a model object.

The option **Name**, available in the **Model Tree Node Text** menu in the Model Builder toolbar, represents the name used for scoping. The scope names are used to access the different parts of the model object. This is important, for example, when working with global variables for defining the constraints and objective functions

for an optimization study. In the figure below, the variables `mass`, `freq`, and `maxStress` are referenced by scope names: `comp1.mass`, `comp1.solid.freq`, and `comp1.maxStress`.

The screenshot shows the 'Objective Function' and 'Constraints' sections of a software interface. The 'Objective Function' section includes a table with columns for 'Expression', 'Description', and 'Evaluate for'. Below the table are dropdown menus for 'Type' (Minimization), 'Multiple objectives' (Sum of objectives), and 'Solution' (Use first). The 'Constraints' section includes a table with columns for 'Expression', 'Lower bound', 'Upper bound', and 'Evaluate for'.

Expression	Description	Evaluate for
comp1.mass	Bracket mass	Stationary
		Eigenfrequency

Type: Minimization

Multiple objectives: Sum of objectives

Solution: Use first

Expression	Lower bound	Upper bound	Evaluate for
real(comp1.solid.freq)	minFreq		Eigenfrequency
comp1.maxStress/maxStressLimit		1	Stationary
d_O_Cmp	3		Eigenfrequency

Using scope names avoids name collisions in cases where there are multiple model components or multiple physics interfaces with identical variable names.

## Creating a Model Object

If you create an application using the Model Builder and the Application Builder, then a model object `model` is automatically created the first time you enter the Model Builder. This is then available as a reserved variable name. When using the Model Wizard, the creation of the model tag is automatically handled.

You can create additional model objects with calls to the `createModel` method. Such additional model objects will not be visible in the Model Builder (only `model` is).

For more information on working with several model objects, see the section “Working with Model Objects” on page 51.

## Creating Model Components and Model Object Nodes

---

A model contains one or more model components. You create a model component as follows:

```
model.modelNode().create("comp1");
```

The component is given a definite spatial dimension when you create a geometry node:

```
model.geom().create("geom1", 2);
```

where the second argument can be 0, 1, 2, or 3, depending on the spatial dimension. In the example above, the spatial dimension is 2.

In addition to creating model components and geometry nodes, there are create methods for many of the nodes in the model tree.

Whether the geometry should be interpreted as being axisymmetric or not is determined by a Boolean property that you can assign as follows:

```
boolean makeaxi = true;  
model.geom("geom1").axisymmetric(makeaxi);
```

The axisymmetric property is only applicable to models of spatial dimension 1 or 2.



Using the Model Wizard, if you first create a **Blank Model** and then add a component using the Model Builder, you will be prompted to choose the space dimension of the component. This operation will, in addition to creating a component, also create a geometry and mesh node. For example, selecting a 2D component corresponds to the following lines of code:

```
model.modelNode().create("comp1");  
model.geom().create("geom1", 2);  
model.mesh().create("mesh1", "geom1");
```

## Get and Set Methods for Accessing Properties

---

The get and set methods are used to access and assign, respectively, property values in the different parts of the model object. To assign individual elements of a vector or matrix, the setIndex method is used. The property values can be of the basic data types: String, int, double, and boolean, as well as vectors or matrices of these types (1D or 2D arrays).

The `get`, `set`, and `create` methods (described in the previous section) are also accessible from the model tree by right-clicking and selecting **Copy as Code to Clipboard**.

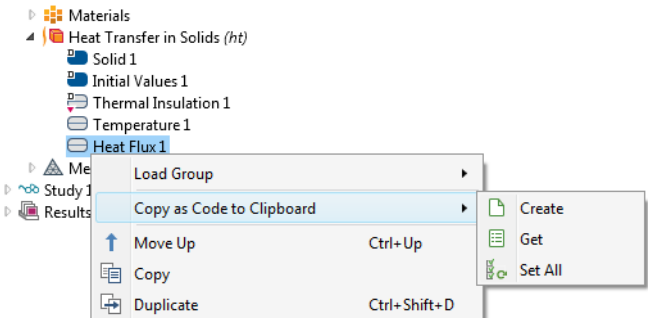

### THE GET METHODS

The family of `get` methods is used to retrieve the values of properties. For example, the `getDouble` method can be used to retrieve the value of the predefined element size property `hauto` for a mesh and store it in a variable `hv`:

```
double hv = model.mesh("mesh1").feature("size").getDouble("hauto");
```

See the section “Example Code” on page 33 below for more information on the property `hauto`.

The syntax for the family of `get` methods for the basic data types is summarized in the following table:

TYPE	SYNTAX
String	<code>getString(String name)</code>
String array	<code>getStringArray(String name)</code>
String matrix	<code>getStringMatrix(String name)</code>
Integer	<code>getInt(String name)</code>
Integer array	<code>getIntArray(String name)</code>
Integer matrix	<code>getIntMatrix(String name)</code>
Double	<code>getDouble(String name)</code>
Double array	<code>getDoubleArray(String name)</code>
Double matrix	<code>getDoubleMatrix(String name)</code>
Boolean	<code>getBoolean(String name)</code>
Boolean array	<code>getBooleanArray(String name)</code>
Boolean matrix	<code>getBooleanMatrix(String name)</code>

All arrays are returned as copies of the data; writing to a retrieved array does not change the data in the model object. To change the contents of an array in the model object, use one of the methods `set` or `setIndex`.

Automatic type conversion is attempted from the property type to the requested return type.

## THE SET METHOD

The syntax for assignment using the `set` method is exemplified by this line of code, which sets the title of a plot group `pg1`:

```
model.result("pg1").set("title", "Temperature T in Kelvin");
```

The first argument is a string with the name of the property, in the above example `"title"`. The second argument is the value and can be a basic type as indicated by the table below.

TYPE	SYNTAX
String	<code>set(String name,String val1)</code>
String array	<code>set(String name,new String[]{"val1","val2"})</code>
String matrix	<code>set(String name,new String[][]{{"1","2"},"3","4"})</code>
Integer	<code>set(String name,17)</code>
Integer array	<code>set(String name,new int[]{1,2})</code>
Integer matrix	<code>set(String name,new int[][]{{1,2},{3,4}})</code>
Double	<code>set(String name,1.3)</code>
Double array	<code>set(String name,new double[]{1.3,2.3})</code>
Double matrix	<code>set(String name,new double[][]{{1.3,2.3},{3.3,4.3}})</code>
Boolean	<code>set(String name,true)</code>
Boolean array	<code>set(String name,new boolean[]{true,false})</code>
Boolean matrix	<code>set(String name,new boolean[][]{{true, false},{false, false}})</code>

Using the `set` method for an object returns the object itself. This allows you to append multiple calls to `set` as follows:

```
model.result("pg1").set("edgecolor", "black").set("edges", "on");
```

The previous line of code assigns values to both the `edgecolor` and `edges` properties of the plot group `pg1` and is equivalent to the two lines:

```
model.result("pg1").set("edgecolor", "black");
model.result("pg1").set("edges", "on");
```

In this case, the `set` method returns a plot group object.

Automatic type conversion is attempted from the input value type to the property type. For example, consider a model parameter `a` that is just a decimal number with no unit. Its value can be set with the statement:

```
model.param().set("a", "7.54");
```

where the value "7" is a string. In this case, the following syntax is also valid:

```
model.param().set("a",7.54);
```

## THE SETINDEX METHOD

The `setIndex` method is used to assign a value to a 1D or 2D array element at a position given by one or two indices (starting from index 0).

The following line illustrates using `setIndex` with one index:

```
model.physics("c").feature("cfeq1").setIndex("f", "2.5", 0);
```

The following line illustrates using `setIndex` with two indices:

```
model.physics("c").feature("cfeq1").setIndex("c", "-0.1", 0, 1);
```

For the `setIndex` method in general, use one of these alternatives to set the value of a single element:

```
setIndex(String name,String value,int index);  
setIndex(String name,String value,int index1,int index2);
```

The `name` argument is a string with the name of the property. The `value` argument is a string representation of the value. The indices start at 0, for example:

```
setIndex(name,value,2);
```

sets the third element of the property name to value.

The `setIndex` method returns an object of the same type, which means that `setIndex` methods can be appended just like the `set` method.

If the index points beyond the current size of the array, then the array is extended as needed before the element at `index` is set. The values of any newly created intermediate elements are undefined.

The method `setIndex` and `set` can both be used to assign values in ragged arrays. For example, consider a ragged array with 2 rows. The code statements:

```
setIndex(name,new String[]{"1","2","3"},0);  
setIndex(name,new String[]{"4","5"},1);
```

sets the first and second row of the array and are equivalent to the single statement:

```
set("name",new String[][]{{"1","2","3"},"4","5"});
```

## METHODS ASSOCIATED WITH SET AND GET METHODS

For object types for which the `set`, `setIndex`, and `get` methods can be used, the following additional methods are available, exemplified by the case of a Heat Transfer in Solids physics interface:



```
// String[] properties();
String[] props =
model.component("comp1").physics("ht").feature("solid1").properties();
```

returns the names of all available properties,

```
// boolean hasProperty(String name);
boolean b =
model.component("comp1").physics("ht").feature("solid1").hasProperty("k_mat");
```

returns true if the feature has the named property,

```
// String[] getAllowedPropertyValues(String name);
String[] vals =
model.component("comp1").physics("ht").feature("solid1").getAllowedPropertyValues("k_mat");
```

returns the allowed values for named properties, if it is a finite set.

## EXAMPLE CODE

The following code block can be used to warn an application's user of excessive simulation times based on the element size:

```
if (model.mesh("mesh1").feature("size").getDouble("hauto") <= 3) {
    exp_time = "Solution times may be more than 10 minutes for finer element
    sizes.";
}
```

In the above example, `getDouble` is used to retrieve the value of the property `hauto`, which corresponds to the **Element Size** parameter **Predefined** in the **Settings** window of the **Size** node under the **Mesh** node. This setting is available when the **Sequence type** is set to **User-controlled mesh**, in the **Settings** window of the **Mesh** node.

The following line of code retrieves an array of strings corresponding to the legends of a 1D point graph.

```
String[] legends =
model.results("pg3").feature("ptgr1").getStringArray("legends");
```

The figure below shows an example of a vector of legends in the **Settings** window of the corresponding **Point Graph**.

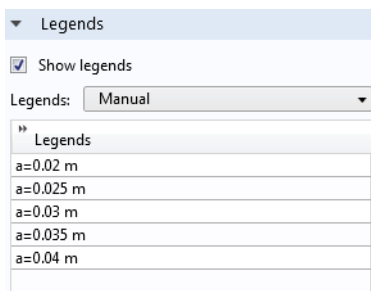

The following line of code sets the **Dataset** `dset1` for the **Plot Group** `pg1`:

```
model.result("pg1").set("data", "dset1");
```

The following lines of code set the anisotropic diffusion coefficient for a Poisson's equation problem on a block geometry.

```
model.geom("geom1").create("blk1", "Block");
with(model.geom("geom1").feature("blk1"));
  set("size", new String[]{"10", "1", "1"});
endwith();
model.geom("geom1").run();
with(model.physics("c").feature("cfeq1"));
  setIndex("c", "-0.1", 0, 1);
  setIndex("c", "-0.2", 0, 6);
  setIndex("f", "2.5", 0);
endwith();
```

The 3-by-3 diffusion coefficient matrix indices follow column-first ordering.

The code below sets the global parameter `L` to a fixed value.

```
model.param().set("L", "10[cm]");
```

The code below sets the material link index to the string variable `alloy`, defined under the **Declarations** node.

```
model.material("matlnk1").set("link", alloy);
```

The code below sets the coordinates of a cut point dataset `cpt1` to the values of the 1D array `samplecoords[]`.

```
with(model.result().dataset("cpt1"));
  set("pointx", samplecoords[0]);
  set("pointy", samplecoords[1]);
  set("pointz", samplecoords[2]);
endwith();
```

The code below sets the components of a deformation plot.

```
with(model.result("pg7").feature("surf1").feature("def"));
  setIndex("expr", "withstru", 0);
  setIndex("expr", "withstrv", 1);
  setIndex("expr", "withstrw", 2);
endwith();
```

The code below sets the title and color legend of a plot group `pg2` and then regenerates the plot.

```
with(model.result("pg2"));
  set("titletype", "auto");
endwith();
with(model.result("pg2").feature("surf1"));
  set("colorlegend", "on");
endwith();
model.result("pg2").run();
```

## Parameters and Variables

---

This code defines a global parameter L with **Expression** 0.5[m] and **Description** Length:

```
model.param().set("L", "0.5[m]");
model.param().descr("L", "Length");
```

There is an alternative syntax using three input arguments:

```
model.param().set("L", "0.5[m]", "Length");
```

You can also use the `with` syntax to set the **Expression** and **Description** for several parameters, for example:

```
with(model.param());
  set("L", "0.5[m]");
  descr("L", "Length");
  set("wd", "10[cm]");
  descr("wd", "Width");
  set("T0", "500[K]");
  descr("T0", "Temperature");
endwith();
```

which corresponds to the following **Settings** window for **Global Definitions>Parameters**:

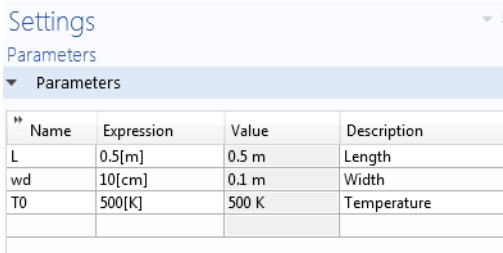

The screenshot shows a 'Settings' window with a 'Parameters' section. Below the section header is a table with four columns: Name, Expression, Value, and Description. The table contains three rows of data.

Name	Expression	Value	Description
L	0.5[m]	0.5 m	Length
wd	10[cm]	0.1 m	Width
T0	500[K]	500 K	Temperature

### ACCESSING A GLOBAL PARAMETER

You would typically use the **Editor Tools** window for generating code for setting the value of a global parameter. While in the Method Editor, right-click the parameter and select **Set**.

To set the value of the global parameter L to 10 cm:

```
model.param().set("L", "10[cm]");
```

To get the global parameter L and store it in a double variable Length:

```
double Length = model.param().evaluate("L");
```

The evaluation is in this case with respect to the base **Unit System** defined in the model tree root node.

To return the unit of the parameter L, if any, use:

```
String Lunit=model.param().evaluateUnit("L");
```

To write the value of a model expression to a global parameter, you typically need to convert it to a string. The reason is that model expressions may contain units.

Multiply the value of the variable Length with 2 and write the result to the parameter L including the unit of cm.

```
Length = 2*Length;  
model.param().set("L", toString(Length) + "[cm]");
```

To return the value of a parameter in a different unit than the base **Unit System**, use:

```
double Length_real = model.param().evaluate("L","cm");
```

For the case where the parameter is complex valued, the real and imaginary parts can be returned as a double vector of length 2:

```
double[] realImag = model.param().evaluateComplex("Ex", "V/m");
```

For parameters that are numbers without units, you can use a version of the set method that accepts a double instead of a string. For example, the lines

```
double a_double = 7.65;  
model.param().set("a_param", a_double);
```

assigns the value 7.65 to the parameter a\_param.

## VARIABLES

The syntax for accessing and assigning variables is similar to that of parameters. For example, the code:

```
with(model.variable("var1"));  
    set("F", "150[N]");  
    descr("F", "Force");  
endwith();
```

assigns the **Expression** 150[N] to the variable with **Name** F.

The following code assigns a model expression to the variable f:

```
with(model.variable("var1"));  
    set("f", "(1 - alpha)^2/(alpha^3 + epsilon) + 1");  
endwith();
```

and the following code stores the model expression for the same variable in a string fs.

```
String fs = model.variable("var1").get("f");
```

## Unary and Binary Operators in the Model Object

---

The table below describes the unary and binary operators that can be used when accessing a model object, such as the model expressions used when defining parameters, variables, material properties, and boundary conditions, as well as in expressions used in results for postprocessing and visualization.

PRECEDENCE LEVEL	SYMBOL	DESCRIPTION
1	( ) { } .	grouping, lists, scope
2	^	power
3	! - +	unary: logical not, minus, plus
4	[ ]	unit
5	* /	binary: multiplication, division
6	+ -	binary: addition, subtraction
7	< <= > >=	comparisons: less-than, less-than or equal, greater-than, greater-than or equal
8	== !=	comparisons: equal, not equal
9	&&	logical and
10		logical or
11	,	element separator in lists

The following example code creates a variable to indicate whether the effective von Mises stress exceeds 200 MPa by using the inequality `solid.mises>200[MPa]`:

```
model.variable().create("var1");
model.variable("var1").model("comp1");
model.variable("var1").set("hi_stress", "solid.mises>200[MPa]");
```

The following code demonstrates using this variable in a surface plot:

```
model.result().create("pg3", "PlotGroup3D");
model.result("pg3").create("surf1", "Surface");
with(model.result("pg3").feature("surf1"));
  set("expr", "hi_stress");
endwith();
model.result("pg3").run();
```

The same plot can be created by directly using the inequality expression in the surface plot expression as follows:

```
with(model.result("pg3").feature("surf1"));
  set("expr", "solid.mises > 200[MPa]");
endwith();
model.result("pg3").run();
```

## Geometry

---

Once the **Geometry** node is created (see “Creating Model Components and Model Object Nodes” on page 29) you can add geometric features to the node. For example, add a square using default position (0, 0) and default size 1:

```
model.geom("geom1").create("sq1", "Square");
```

The first input argument "sq1" to the `create` method is a tag, a handle, to the square. The second argument "Square" is the type of geometry object.

Add another square with a different position and size:

```
model.geom("geom1").create("sq2", "Square");
with(model.geom("geom1").feature("sq2"));
  set("pos", new String[]{"0.5", "0.5"});
  set("size", "0.9");
endwith();
```

The `with` statement in the above example is used to make the code more compact and, without using `with`, the code statements above are equivalent to:

```
model.geom("geom1").feature("sq2").set("pos", new String[]{"0.5", "0.5"});
model.geom("geom1").feature("sq2").set("size", "0.9");
```

Take the set difference between the first and second square:

```
model.geom("geom1").create("dif1", "Difference");
with(model.geom("geom1").feature("dif1").selection("input"));
  set(new String[]{"sq1"});
endwith();
with(model.geom("geom1").feature("dif1").selection("input2"));
  set(new String[]{"sq2"});
endwith();
```

To build the entire geometry, you call the method `run` for the **Geometry** node:

```
model.geom("geom1").run();
```

The above example corresponds to the following **Geometry** node settings:

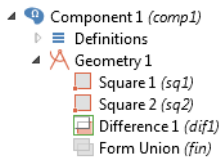

In this way, you have access to the functionality that is available in the geometry node of the model tree. Use **Record Code** or any of the other tools for automatic generation of code to learn more about the syntax and methods for other geometry operations.

## REMOVING MODEL TREE NODES

You can remove geometry objects using the remove method:

```
model.geom("geom1").feature().remove("sq2");
```

Remove a series of geometry objects (circles) with tags c1, c2, ..., c10:

```
for (int n = 1; n <= 10; n = n+1) {  
    model.geom("geom1").feature().remove("c"+n);  
}
```

The syntax "c"+n automatically converts the integer n to a string before concatenating it to the string "c".

To remove all geometry objects:

```
for (String tag : model.geom("geom1").feature().tags()) {  
    model.geom("geom1").feature().remove(tag);  
}
```

However, the same can be achieved with the shorter:

```
model.geom("geom1").feature().clear();
```

In a similar way, you can remove other model tree nodes.

## Mesh

---

The following line adds a **Mesh** node, with tag mesh1, linked to the geometry with tag geom1:

```
model.mesh().create("mesh1", "geom1");
```

You can control the mesh element size either by a preconfigured set of sizes or by giving low-level input arguments to the meshing algorithm.

The following line:

```
model.mesh("mesh1").autoMeshSize(6);
```

corresponds to a mesh with **Element size** set to **Coarse**. The argument to the method autoMeshSize ranges from 1-9, where 1 is **Extremely fine** and 9 is **Extremely coarse**.

To generate the mesh, you call the run method for the mesh node:

```
model.mesh("mesh1").run();
```

Use **Record Code** to generate code for other mesh operations.

The code below shows an example where the global mesh parameters have been changed.

```
model.mesh("mesh1").automatic(false); // Turn off Physics-controlled mesh  
with(model.mesh("mesh1").feature("size"));  
set("custom", "on"); // Use custom element size
```

```

set("hmax", "0.09"); // Maximum element size
set("hmin", "3.0E-3"); // Minimum element size
set("hgrad", "1.2"); // Maximum element growth rate
set("hcurve", "0.35"); // Curvature factor
set("hnarrow", "1.5"); // Resolution of narrow regions
endwith();
model.mesh("mesh1").run();

```

The above example corresponds to the following **Mesh** node settings:

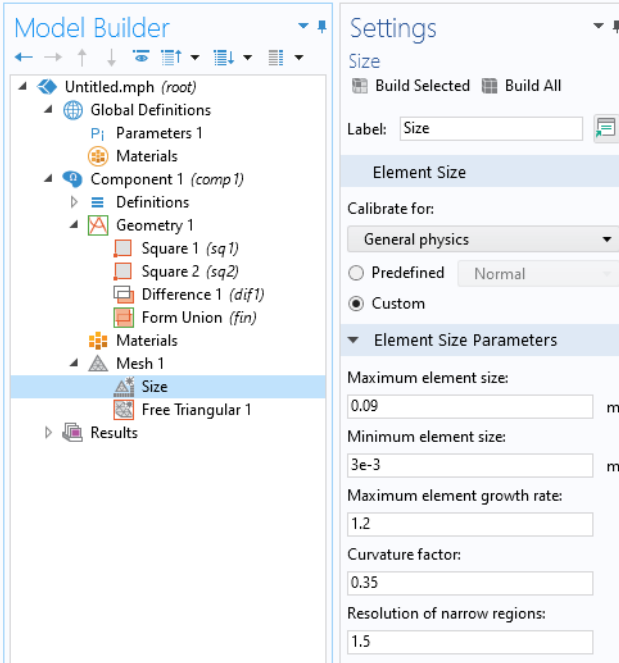

Note that you can also set local element size properties for individual points, edges, faces, and domains. Use **Record Code** or any of the other tools for automatic generation of code to learn more about the syntax and methods for other mesh operations.

## Physics

---

Consider analyzing stationary heat transfer in the solid rectangular geometry shown earlier. To create a physics interface, for **Heat Transfer in Solids**, use:

```

model.physics().create("ht", "HeatTransfer", "geom1");

```



The first input argument to the `create` method is a physics interface tag that is used as a handle to this physics interface. The second input argument is the type of physics interface. The third input argument is the tag of the geometry to which the physics interface is assigned.

To set a fixed temperature boundary condition on a boundary, you first create a `TemperatureBoundary` feature using the following syntax:

```
model.physics("ht").create("temp1", "TemperatureBoundary", 1);
```

The first input argument to `create` is a feature tag that is used as a handle to this boundary condition. The second input argument is the type of boundary condition. The third input argument is the spatial dimension for the geometric entity that this boundary condition should be assigned to. Building on the previous example of creating a 2D rectangle, the input argument being 1 means that the dimension of this boundary is 1 (that is, an edge boundary in 2D).

The next step is to define which selection of boundaries this boundary condition should be assigned to. To assign it to boundary 1 use:

```
model.physics("ht").feature("temp1").selection().set(new int[]{1});
```

To assign it to multiple boundaries, for example 1 and 3, use:

```
model.physics("ht").feature("temp1").selection().set(new int[]{1, 3});
```

To set the temperature on the boundary to a fixed value of 400 K, use:

```
model.physics("ht").feature("temp1").set("T0", "400[K]");
```

The following lines of code show how to define a second boundary condition for a spatially varying temperature, varying linearly with the coordinate `y`:

```
model.physics("ht").create("temp2", "TemperatureBoundary", 1);
model.physics("ht").feature("temp2").selection().set(new int[]{4});
model.physics("ht").feature("temp2").set("T0", "(300 + 10[1/m]*y)[K]");
```

The resulting model tree structure is shown in the figure below.

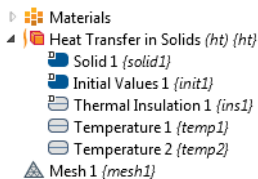

Use **Record Code** or any of the other tools for automatic generation of code to learn more about the syntax and methods for other physics interface features and other physics interfaces.

## CREATING AND REMOVING MODEL TREE NODES

Below is a larger block of code that removes, creates, and accesses physics interface feature nodes. It uses the `Iterator` class and methods available in the `java.util` package. For more information, see the Java® documentation.

```
String[] flowrate = column1;
String[] Mw = column2;
java.util.Iterator<PhysicsFeature> iterator =
    model.physics("pf1").feature().iterator();
while (iterator.hasNext()) {
    if (iterator.next().getType().equals("Inlet"))
        iterator.remove();
}
if (flowrate != null) {
    for (int i = 0; i < flowrate.length; i++) {
        if (flowrate[i].length() > 0) {
            if (Mw[i].length() > 0) {
                int d = 1 + i;
                model.physics("pf1").create("in1" + d, "Inlet");
                model.physics("pf1").feature("in1" + d).setIndex("spec", "3", 0);
                model.physics("pf1").feature("in1" + d).set("qscm0", flowrate[i]);
                model.physics("pf1").feature("in1" + d).set("Mn", Mw[i]);
                model.physics("pf1").feature("in1" + d).selection().set(new int[]{d});
            }
        }
    }
}
```

The need to remove and create model tree nodes is fundamental when writing methods because the state of the model object is changing each time a model tree node is run. In the method above, the number of physics feature nodes are dynamically changing depending on user inputs. Each time the simulation is run, old nodes are removed first and then new nodes are added.

## Material

---

A material, represented in the Model Builder by a **Materials** node, is a collection of property groups, where each property group defines a set of material properties, material functions, and model inputs that can be used to define, for example, a temperature-dependent material property. A property group usually defines properties used by a particular material model to compute a fundamental quantity.

To create a **Materials** node:

```
model.material().create("mat1", "Common", "comp1");
```

You can give the material a name, for example, Aluminum, as follows:

```
model.material("mat1").label("Aluminum");
```

The following lines of code shows how to create a basic material property group for heat transfer:

```
with(model.material("mat1").propertyGroup("def"));
  set("thermalconductivity", new String[]{"238[W/(m*K)]"});
  set("density", new String[]{"2700[kg/m^3]"});
  set("heatcapacity", new String[]{"900[J/(kg*K)]"});
endwith();
```

The built-in property groups have a read-only tag. In the above example, the tag `def` represents the property group **Basic** in the model tree.

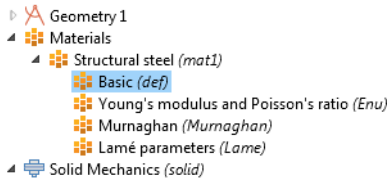

The resulting model tree and **Material** node settings are shown in the figure below.

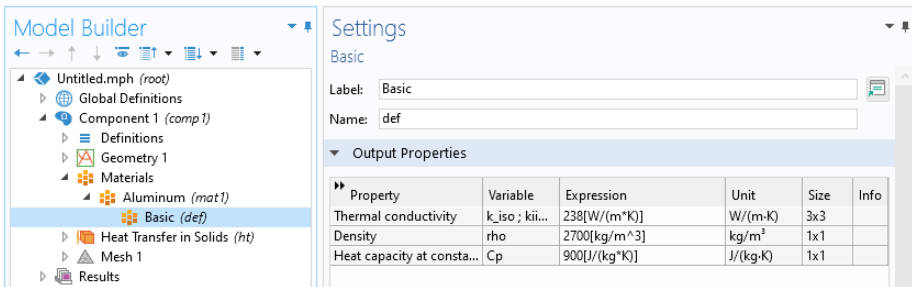

Note that some physics interfaces do not require a material to be defined. Instead, the corresponding properties can be accessed directly in the physics interface. This is also the case if the physics model settings are changed from **From material** to **User defined**. For example, for the **Heat Transfer in Solids** interface, this setting can be

found in the **Settings** window of the subnode **Solid**, in the sections **Heat Conduction, Solid** and **Thermodynamics, Solid**, as shown in the figure below.

▼ Heat Conduction, Solid

Thermal conductivity:

k User defined ▼

0	0	0	W/(m·K)
0	0	0	
0	0	0	

Full ▼

▼ Thermodynamics, Solid

Density:

$\rho$  From material ▼

Heat capacity at constant pressure:

$C_p$  From material ▼

Use **Record Code** or any of the other tools for automatic generation of code to learn more about the syntax and methods for materials.

## Study

---

The **Study** node in the model tree contains one or more study steps, instructions that are used to set up solvers and solve for the dependent variables. The settings for the **Study** and the **Solver Configurations** nodes can be quite complicated. Consider the simplest case for which you just need to create a study, add a study step, and run it.

Building on the example from the previous sections regarding stationary heat transfer, let's add a **Stationary** study step.

```
model.study().create("std1"); // Study with tag std1
model.study("std1").create("stat", "Stationary");
model.study("std1").run();
```

The call to the method `run` automatically generates a solver sequence in a data structure `model.sol` and then runs the corresponding solver. The settings for the solver are automatically configured by the combination of physics interfaces you have chosen. You can manually change these settings, as shown later in this section. The data structure `model.sol` roughly corresponds to the contents of the **Solver Configurations** node under the **Study** node in the model tree.

All low-level solver settings are available in `model.sol`. The structure `model.study` is used as a high-level instruction indicating which settings should be created in `model.sol` when a new solver sequence is created.

For backward compatibility, some of the low-level settings in `model.sol` are automatically generated when using **Record Code**.

The example below shows a somewhat more elaborate case of programming the study that would be applicable for the stationary heat transfer example shown earlier. The instructions below more closely resemble the output autogenerated by using the **Record Code** option.

First create instances of the **Study** node (with tag `std1`) and a **Stationary** study step subnode:

```
model.study().create("std1");
model.study("std1").create("stat", "Stationary");
```

The actual settings that determine how the study is run are contained in a sequence of operations in the **Solution** data structure, with tag `sol1`, which is linked to the study:

```
model.sol().create("sol1");
model.sol("sol1").study("std1");
```

The following code defines the sequence of operations contained in `sol1`.

First, create a **Compile Equations** node under the **Solution** node to determine which study and study step will be used:

```
model.sol("sol1").create("st1", "StudyStep");
model.sol("sol1").feature("st1").set("study", "std1");
model.sol("sol1").feature("st1").set("studystep", "stat");
```

Next, create a **Dependent Variables** node, which controls the scaling and initial values of the dependent variables and determines how to handle variables that are not solved for:

```
model.sol("sol1").create("v1", "Variables");
```

Now create a **Stationary Solver** node. The **Stationary Solver** contains the instructions that are used to solve the system of equations and compute the values of the dependent variables.

```
model.sol("sol1").create("s1", "Stationary");
```

Add subnodes to the **Stationary Solver** node to choose specific solver types. In this example, use an **Iterative** solver:

```
model.sol("sol1").feature("s1").create("i1", "Iterative");
```

Add a **Multigrid** preconditioner subnode:

```
model.sol("sol1").feature("s1").feature("i1").create("mg1", "Multigrid");
```

You can have multiple **Solution** data structures in a study node (such as `sol1`, `sol2`, and so on) defining different sequences of operations. The process of notifying the study of which one to use is done by “attaching” the **Solution** data structure `sol1` with study `std1`:

```
model.sol("sol1").attach("std1");
```

The attachment step determines which **Solution** data structure sequence of operations should be run when selecting **Compute** in the COMSOL Desktop user interface.

Finally, run the study, which is equivalent to running the **Solution** data structure sol1:

```
model.sol("sol1").runAll();
```

The resulting **Study** node structure is shown in the figure below. Note that there are several additional nodes added automatically. These are default nodes and you can edit each of these nodes by explicit method calls. You can edit any of the nodes while using **Record Code** to see the corresponding methods and syntax used.

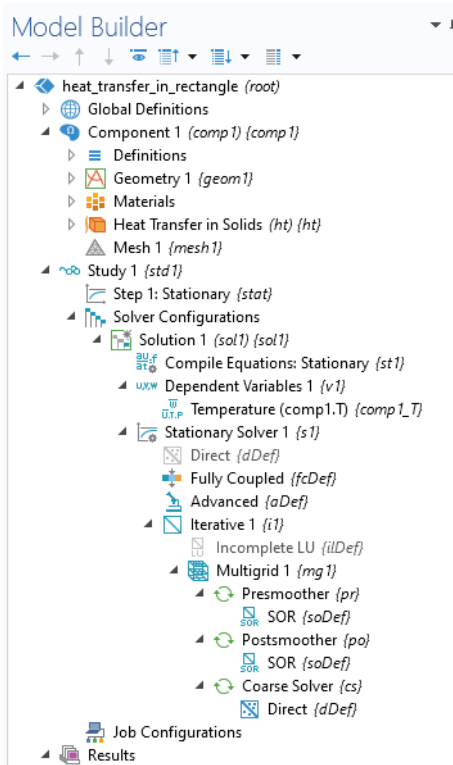

## MODIFYING LOW-LEVEL SOLVER SETTINGS

To illustrate how some of the low-level solver settings can be modified, consider a case where the settings for the **Fully Coupled** node are modified. This subnode controls the type of nonlinear solver used.

The first line below may not be needed depending on whether the **Fully Coupled** subnode has already been generated or not (it could have been automatically generated by code similar to what was shown above).

```
model.sol("sol1").feature("s1").create("fc1", "FullyCoupled");
with(model.sol("sol1").feature("s1").feature("fc1"));
  set("dtech", "auto"); // The Nonlinear method (Newton solver)
  set("initstep", "0.01"); // Initial damping factor
  set("minstep", "1.0E-6"); // Minimum damping factor
  set("rstep", "10"); // Restriction for step-sized update
  set("useminsteprecovery", "auto"); // Use recovery damping factor
  set("minsteprecovery", "0.75"); // Recovery damping factor
  set("ntermauto", "tol"); // Termination technique
  set("maxiter", "50"); // Maximum number of iterations
  set("ntolfact", "1"); // Tolerance factor
  set("termonres", "auto"); // Termination criterion
  set("reserrfact", "1000"); // Residual factor
endwith();
```

For more information on the meaning of these and other low-level solver settings, see the *Solver* section of the *Programming Reference Manual*.

Changing the low-level solver settings requires that `model.sol` has first been created. It is always created the first time you compute a study, however, you can trigger the automatic generation of `model.sol` as follows:

```
model.study().create("std1");
model.study("std1").create("stat", "Stationary");
model.study("std1").showAutoSequences("sol");
```

where the call to `showAutoSequences` corresponds to the option **Show Default Solver**, which is available when right-clicking the **Study** node in the model tree.

This can be used if you do not want to take manual control over the settings in `model.sol` (the solver sequence) and are prepared to rely on the physics interfaces to generate the solver settings. If your application makes use of the automatically generated solver settings, then updates and improvements to the solvers in future versions are automatically included. Alternatively, the automatically generated `model.sol` can be useful as a starting point for your own edits to the low-level solver settings.

## CHECKING IF A SOLUTION EXISTS

When creating an application it is often useful to keep track of whether a solution exists or not. The method `model.sol("sol1").isEmpty()` returns a `boolean` and is `true` if the solution structure `sol1` is empty. Consider an application where the solution state is stored in a string `solutionState`. The following code sets the state depending on the output from the `isEmpty` method:

```
if (model.sol("sol1").isEmpty()) {
  solutionState = "nosolution";
}
```

```

else {
    solutionState = "solutionexists";
}

```

Alternatively, `solutionState` can be initialized to `nosolution` and the following code is used to indicate a state change corresponding to the input values having changed:

```

if (solutionState.equals("solutionexists")) {
    solutionState = "inputchanged";
}

```

Almost all of the example applications in the Application Libraries use this technique.

## Results

---

The **Results** node contains nodes for **Datasets**, **Derived Values**, **Tables**, **Plot Groups**, **Export**, and **Reports**. As soon as a solution is obtained, a set of **Plot Group** nodes are automatically created. In the example of **Heat Transfer in Solids**, when setting up such an analysis in the Model Builder, two **Plot Group** nodes are added automatically. The first one is a **Surface** plot of the **Temperature** and the second one is a **Contour** plot showing the isothermal contours. Below you will see how to set up the corresponding plots manually.

First create a 2D plot group with tag `pg1`:

```

model.result().create("pg1", "PlotGroup2D");

```

Change the **Label** of the **Plot Group**:

```

model.result("pg1").label("Temperature (ht)");

```

Use the dataset `dset1` for the **Plot Group**:

```

model.result("pg1").set("data", "dset1");

```

Create a **Surface** plot for `pg1` with settings for the color table used, the intra-element interpolation scheme, and the dataset referring to the parent of the **Surface** plot node, which is the `pg1` node:

```

model.result("pg1").feature().create("surf1", "Surface");
model.result("pg1").feature("surf1").label("Surface");
with(model.result("pg1").feature("surf1"));
    set("colortable", "ThermalLight");
    set("smooth", "internal");
    set("data", "parent");
endwith();

```

Now create a second 2D plot group with contours for the isotherms:

```

model.result().create("pg2", "PlotGroup2D");
model.result("pg2").label("Isothermal Contours (ht)");
with(model.result("pg2"));

```



```

    set("data", "dset1");
endwith();
model.result("pg2").feature().create("con1", "Contour");
model.result("pg2").feature("con1").label("Contour");
with(model.result("pg2").feature("con1"));
    set("colortable", "ThermalLight");
    set("smooth", "internal");
    set("data", "parent");
endwith();

```

Finally, generate the plot for the **Plot Group** pg1:

```
model.result("pg1").run();
```

To find the maximum temperature, add a **Surface Maximum** subnode to the **Derived Values** node as follows:

First create the **Surface Maximum** node with tag max1:

```
model.result().numerical().create("max1", "MaxSurface");
```

Note that in this context the method corresponding to the **Derived Values** node is called `numerical`.

Next, specify the selection. In this case there is only one domain 1:

```
model.result().numerical("max1").selection().set(new int[]{1});
```

Create a **Table** node to hold the numerical result and write the output from max1 to the **Table**:

```

model.result().table().create("tbl1", "Table");
model.result().table("tbl1").comments("Surface Maximum 1 {max1} (T)");
model.result().numerical("max1").set("table", "tbl1");
model.result().numerical("max1").setResult();

```

Use **Record Code** or any of the other tools for automatic generation of code to learn more about the syntax and methods for **Results**.

### *Using Parameterized Solutions in Results*

The code below changes the visualization of a plot group pg1 by setting the property `looplevel`, which controls the solution parameter, to the string variable `svar`.

```

with(model.result("pg1"));
    set("looplevel", new String[]{svar});
endwith();
model.result("pg1").run();

```

The property `looplevel` has a central role in accessing parameterized solutions. Its argument is a 1D string array with one index per "loop level" in a study. The different loop levels correspond to the different nested parameters in a parametric sweep with multiple parameters.

## Loading Data to Tables

By using the `loadFile` method you can import data into a table and then display it using a results table form object or a table surface plot. The following example demonstrates loading data from an Excel file into a table and visualizing the contents using a table surface plot. The file in this example is assumed to be imported, in an application, using a file import form object with a file declaration `file1` as the **File Destination**.

```
model.result().table("tbl1").loadFile("upload:///file1", "", cells);
/*
  The string variable cells contains the spreadsheet selection to be
  imported, for example A1:J7.
```

```

  The following code creates a plot group pg1 with a table surface plot.
  This code is not needed if the embedded model already contains a table
  and a table surface plot.
```

```
*/

model.result().create("pg1", 2);
model.result("pg1").create("tbls1", "TableSurface");
with(model.result("pg1").feature("tbls1"));
  set("table", "tbl1");
endwith();
with(model.result("pg1").feature("tbls1"));
  set("dataformat", "cells");
endwith();
model.result("pg1").feature("tbls1").create("hght1", "TableHeight");
with(model.result("pg1").feature("tbls1").feature("hght1"));
  set("view", "view3");
endwith();
with(model.view("view3").camera());
  set("viewscaletype", "manual");
  set("xscale", "1");
  set("yscale", "1");
  set("zscale", "1");
endwith();
// The following line is needed to update the plot
model.result("pg1").run();
```

## Multiphysics

---

Some of the physics interfaces define a multiphysics analysis by themselves without being coupled to any other interface. This is the case when the physics interface is used for a coupling that is so strong that it does not easily lend itself to be separated into several physics interfaces. In other cases, a set of single physics interfaces, typically two, can be combined by the use of the **Multiphysics** node. For example, a **Joule Heating** analysis is defined as the combination of an **Electric**

**Currents** interface and a **Heat Transfer in Solids** interface with an additional **Electromagnetic Heat Source** node under the **Multiphysics** node. The following lines of code illustrate the corresponding method calls.

```
model.physics().create("ec", "ConductiveMedia", "geom1");
model.physics().create("ht", "HeatTransfer", "geom1");
model.multiphysics().create("emh1", "ElectromagneticHeatSource", "geom1",
    2);
model.multiphysics("emh1").selection().all();
with(model.multiphysics("emh1"));
    set("EMHeat_physics", "ec");
    set("Heat_physics", "ht");
endwith();
```

When using the Model Builder to set up a **Joule Heating** analysis, nodes in addition to those shown above will be created corresponding to Joule heating in thin shells, should they exist in the model, and temperature couplings if there are multiple field variables for electric potential and temperature.

## Working with Model Objects

---

When using the Model Builder in the COMSOL Desktop interface, an embedded model with variable name `model` is automatically created. The embedded model has a special status. For example, the automatic code generation tools only consider the embedded model. In addition, when you save to or load from an MPH file, only the embedded model is saved or loaded. General tools include the **Save Application As** command in the Application Builder and **File > Save As**, from the **File** menu of the COMSOL Desktop environment.

However, in an application you are allowed to create and edit multiple models. Saving and loading such models is done by using the built-in methods `saveModel` and `loadModel`. An MPH file can only contain a single model object.

If you need to create model objects, in addition to the embedded model, use the built-in method `createModel`.

To create a new model you use:

```
Model extmodel = createModel();
```

A unique model tag is created automatically and assigned to the model. If you want to explicitly control the model tag, use:

```
Model extmodel = createModel("My_model_1");
```

where `My_model_1` is a unique tag. It is recommended that you do not use the names `Model1`, `Model2`, `Model3`, and so on, since these names are used by the mechanism that automatically generates model tags for the embedded model when loading and saving MPH files.

The following example retrieves the model tag of the embedded model:

```
String my_modeltag = model.tag();
```

however, you rarely need to use the model tag of the embedded model object.

Instead of creating and building up the contents of a model from scratch, you can load an existing model and edit it.

For example in the Windows operating system, load a model `my_model.mph` from the folder `C:\COMSOL_Work`, by using the built-in method `loadModel`:

```
Model extmodel = loadModel("C:\\COMSOL_Work\\my_model.mph");
```

A unique model tag is created automatically and is assigned to the model upon load. Note the double-backslash syntax in the file name. Backslash (`\`) is a special character in Java and the double backslash is needed in this case.

To make your application portable, you can use the file scheme syntax available in the Application Builder. Assuming you stored the MPH file in the common folder, the call to `loadModel` should be:

```
Model extmodel = loadModel("My_Model_1", "common:///my_model.mph");
```

In this example, the tag `My_Model_1` is important since it is used to retrieve the model from other methods. Once loaded, the model `extmodel` exists in the work space of the current COMSOL Multiphysics or COMSOL Server session. Note that an MPH file can only contain one model object, so there is no ambiguity on which model you refer to when loading an MPH file.

Assume that you, in one method, have loaded the model `extmodel` with the tag `My_Model_1`, such as in the example above. The model variable `extmodel` is not available in other methods. In order to retrieve the model from another method use:

```
Model mymodel = getModel("MyModel_1");
```

The contents of `mymodel` and `extmodel` are the same, but these variables exist in the variable space of two different methods.

The tag `My_Model_1` uniquely identified and retrieved the model object from the current COMSOL Multiphysics or COMSOL Server session.

To clear the contents of a model object, use the built-in method `clearModel`.

For a list of model utility methods, see “Model Utility Methods” on page 95.

## TURNING OFF AND RESETTING THE MODEL HISTORY

When running method code in applications or otherwise in order to automate modeling tasks, the stored model history may become excessively large. The model history is used, for example, when saving to a Model M-file or Model Java-file. Because of this, depending on the repetitive nature of your code, you

may need to temporarily turn off model history recording as illustrated by the following example:

```
model.hist().disable();  
// some code  
model.hist().enable();
```

If you want to reset the model history to an almost minimal sequence of commands that creates the current state of the model object you can use:

```
model.resetHist();
```

In the **File** menu, this functionality is referred to as **Compact History**.

## The Model Object Class Structure

For a full description of the class structure and method signatures, see the HTML document *Java Documentation* available in the *COMSOL Documentation*. You find the Java documentation under **COMSOL API for use with Java®** at the bottom of the Documentation window.

The figure below shows the document as displayed in a the COMSOL documentation viewer.

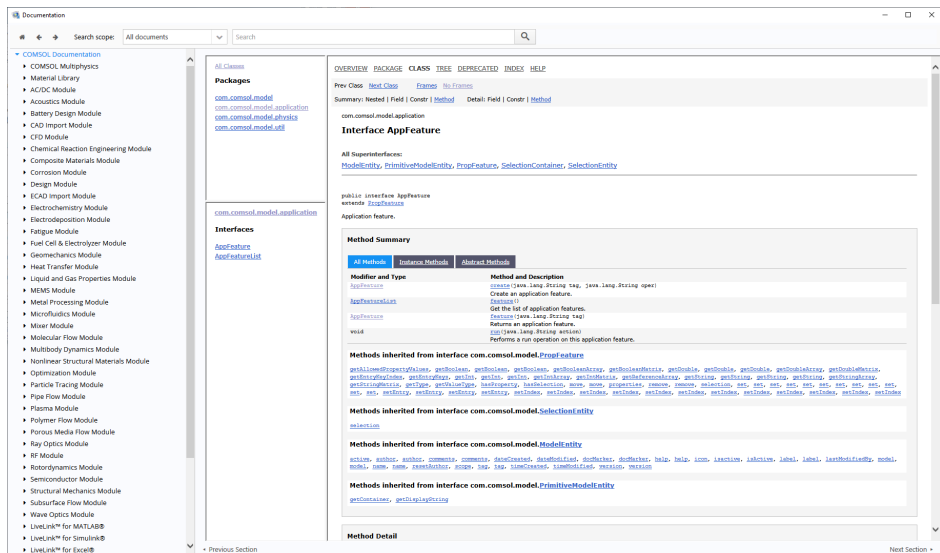

If you encounter a class that you are unfamiliar with you will get help by a tooltip as in the figure below for the output of the `getView` method.

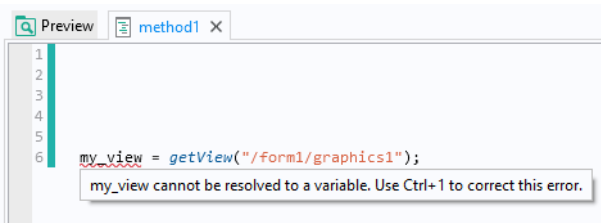

By using the keyboard shortcut `Ctrl+1` the correct type declaration is assigned to the variable as shown in the figure below.

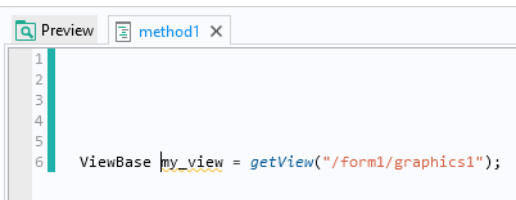

This way you can avoid having to consult the *Java Documentation*.

# The Application Object

---

The application object is a part of the model object and is the data structure that allows access to the user interface features of an application from within a method. The state of the application object is reflected in the COMSOL Desktop user interface by the contents of the Application Builder and its application tree.

You can write code using the Method Editor to directly access and change the features presented in a running application, including button text, icons, colors, and fonts.

The application object gives you access to a subset of the features and settings available in the Application Builder. You can use the application object methods for runtime modifications to the user interface, but not for building a complete user interface. For building the user interface of an application, you need to use the Form editor as described in the book *Introduction to Application Builder*. This section gives an overview of the application object.

## Shortcuts

---

Form objects and other user interface components are referenced in methods by using a certain syntax. For example, using the default naming scheme `form3/button5` refers to a button with name `button5` in `form3` and `form2/graphics3` refers to a graphics object with name `graphics3` in `form2`. You can also change the default names of forms and form objects. For example, if `form1` is your main form then you can change its name to `main`.

To simplify referencing form objects as well as menu, ribbon, and toolbar items by name, you can create shortcuts with a custom name. In the **Settings** window of an object or item, click the button to the right of the **Name** field and type the name of your choice.

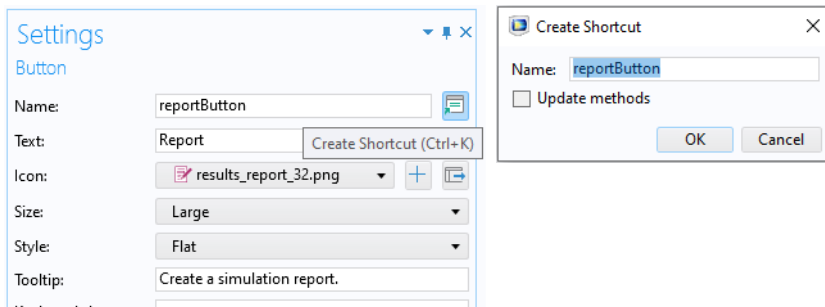

To create or edit a shortcut, you can also use the keyboard shortcut Ctrl+K. All shortcuts that you create are made available in a **Shortcuts** node under **Declarations** in the application tree.

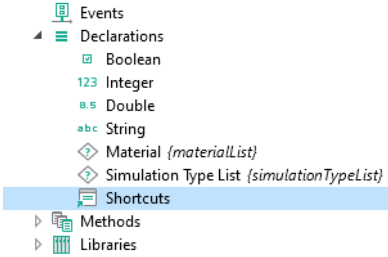

In the **Settings** window for **Shortcuts** shown below, a number of shortcuts were created for a various form objects.

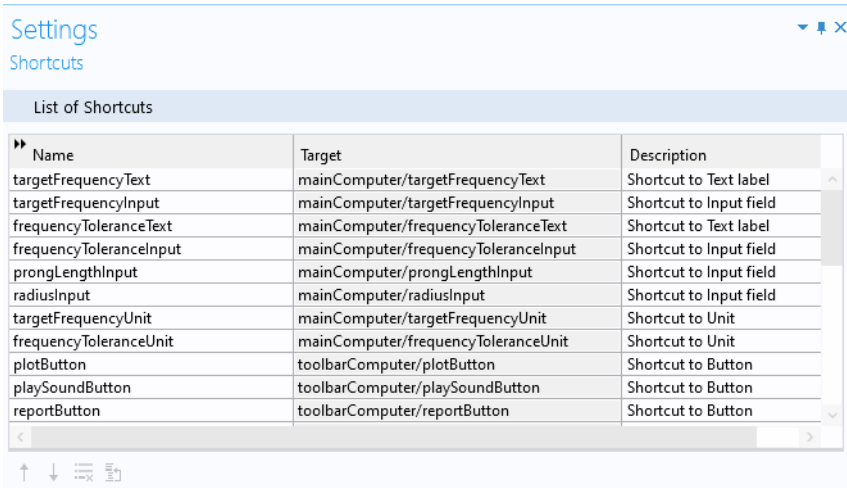

The shortcuts can be referenced in other form objects or in code in the Method Editor. The example below shows a shortcut `tempVis` used as an input argument to a temperature plot.

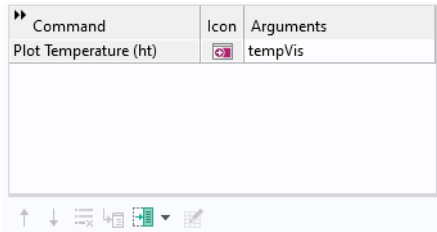



Shortcuts are automatically updated when objects are renamed, moved, copied, and duplicated. They are available in application methods as read-only Java<sup>®</sup> variables, similar to string, integer, double, and Boolean declarations.

Using shortcuts is recommended because it avoids the need to update methods when the structure of the application user interface changes.

Shortcuts can also be created for most objects in the model builder tree.

## EXAMPLE CODE

If the application contains a button named `button1` in a form named `form1`, and the button has a shortcut named `b1`, the following two ways to change the button text to red are equivalent:

```
b1.set("foreground", "red");
app.form("form1").formObject("button1").set("foreground", "red");
```

## Accessing the Application Object

---

In the Method Editor you can directly access the application object part of the model object by using the `app` variable. This variable is a shorthand for `model.app()`.

## The Name of User Interface Components

---

Access the various parts of the application object by using the *name* of a form object, form, item, etc. A *name* in the application object has the same function as the *tag* in the model object omitting the `model.app` part.

For example, in the line of code

```
app.form("form1").formObject("button1").set("enabled", false);
```

the string `form1` is the *name* of a form and `button1` is the *name* of a button.

## Important Classes

---

### THE MAIN APPLICATION CLASS

When working with an application object, the main application class is `AppModel`, which is the type of `model.app()`.

## DECLARATION CLASSES

In addition to the basic data types and shortcut declarations, the **Declaration** node may include Choice List and Unit List declarations. The corresponding classes are `ChoiceList` and `UnitSet`. The parent class to `ChoiceList` and `UnitSet` is called `DataSource`. In addition, `Scalar`, `Array 1D`, and `Array 2D` data types are handled by the `DataSource` class. For more information, see “Data Source” on page 87.

## METHOD CLASS

The `Method` class is used to represent methods. For more information, see “Method Class” on page 93.

## MAIN USER INTERFACE COMPONENT CLASSES

In an application object, the main user interface components correspond to the following classes:

- `MainWindow`
  - The class representing the Main Window node in the application tree.
- `Form`
  - The class representing a form.
- `FormObject`
  - The class representing a form object.
- `Item`
  - The class representing, for example, a menu, toolbar, or ribbon item.
- `AppEvent`
  - The class used for application user-interface events.

Each class has a set of associated methods that are used to edit the corresponding user interface component at runtime. These are described in the following sections.

In addition to the main user interface component classes, there are also list versions of the `Form`, `FormObject`, and `Item` classes. These are: `FormList`, `FormObjectList`, and `ItemList`.

## **Get and Set Methods for the Color of a Form Object**

---

The `get` and `set` methods described in the section “Get and Set Methods for Accessing Properties” on page 29 are applicable to the model object as well as the

`model.app` part of the model object. In addition, the following methods are available for changing the color of a form object:

NAME	SYNTAX	DESCRIPTION
<code>setColor</code>	<code>setColor(String prop, int r, int g, int b)</code>	Set a color property using red, green, and blue values.
<code>getColor</code>	<code>int[] getColor(String prop)</code>	Get the value of a color property as an array of red, green, and blue values.

Not all methods are applicable to all properties. Use Ctrl+Space to use code completion to find out what methods are applicable for a certain object, and what property names and property values are applicable for a certain method.

## General Properties

The following table lists properties that are available for several different user interface components, including form objects. In the table below, a user interface component is referred to as an object.

PROPERTY	VALUE	DEFAULT	DESCRIPTION
<code>background</code>	String	<b>default</b>	The background color for the corresponding user interface element.
<code>enabled</code>	<code>true   false</code>	<b>true</b>	If the value is <b>true</b> , the corresponding object is enabled in the user interface, which means that the user can interact with the object.
<code>font</code>	String	<b>default</b>	The font family name. The special value <b>default</b> means that the font to use is determined by the parent object, which is the corresponding setting in the Settings window of the Forms node.
<code>fontbold</code>	<code>true   false</code>	<b>false</b>	If <b>true</b> the font uses boldface style.
<code>fontitalic</code>	<code>true   false</code>	<b>false</b>	If <b>true</b> the font uses italic style.
<code>fontunderline</code>	<code>true   false</code>	<b>false</b>	If <b>true</b> the font uses underline style.

PROPERTY	VALUE	DEFAULT	DESCRIPTION
<code>fontsize</code>	String	-1	The font size in points. The special value -1 represents the default size, which means that the size is taken from the parent object (the Forms node) or from the system default size if no parent object defines the size.
<code>foreground</code>	String	<code>default</code>	The foreground color for the corresponding user interface element.
<code>visible</code>	<code>true</code>   <code>false</code>	<code>true</code>	If the value is <code>true</code> , the corresponding object is visible in the user interface.

A foreground or background color property is represented by a string value. The available colors are: `black`, `blue`, `cyan`, `gray`, `green`, `magenta`, `red`, `white`, and `yellow`, or a custom color may also be defined. The special value `default` means that the color is taken from the parent object. Depending on the parent type, this could mean that `default` is **Inherit** or **Transparent**, referring to the corresponding setting in the **Settings** window in the Form editor. An arbitrary RGB color can be represented by a string of the form `rgb(red, green, blue)` where `red`, `green`, and `blue` are integers between 0 and 255. Color properties can also be manipulated using the `getColor` and `setColor` methods to directly access the red, green, and blue color components. If a color property has the value `default`, it does not have red, green, and blue values. In this case, the `getColor` method returns the array `[0,0,0]`.

## EXAMPLE CODE

The following example reads the current background color for a form, makes the color darker, and applies the modified color to the same form.

```
int[] rgb = app.form("form1").getColor("background");
for (int i = 0; i < 3; i++)
    rgb[i] /= 2;
app.form("form1").setColor("background", rgb[0], rgb[1], rgb[2]);
```

The following line of code sets the background color to black:

```
app.form("form1").set("background", "black");
```

The following line of code sets the background color to `default` which in the case of the background color property corresponds to the Form editor setting **Transparent**.

```
app.form("form1").set("background", "default");
```

The following line of code sets the background color to the RGB values 125, 45, and 43.

```
app.form("form1").set("background", "rgb(125,45,43)");
```

## The Main Application Methods

---

The main application class `AppModel` has the following methods:

NAME	SYNTAX	DESCRIPTION
<code>mainWindow</code>	<code>MainWindow mainWindow()</code>	Returns the <code>MainWindow</code> object.
<code>form</code>	<code>FormList form()</code>	Returns the list of forms.
<code>form</code>	<code>Form form(String name)</code>	Returns the form with the specified name.
<code>declaration</code>	<code>DataSource declaration(String name)</code>	Returns the declaration object ( <code>Scalar</code> , <code>Array 1D</code> , <code>Array 2D</code> , <code>ChoiceList</code> , or <code>UnitSet</code> ) with the specified name.
<code>hasProperty</code>	<code>boolean hasProperty(String name)</code>	Returns true if there is a modifiable property with the specified name.

The `AppModel` class has the following properties:

PROPERTY	VALUE	DEFAULT	DESCRIPTION
<code>asktosave</code>	<code>true   false</code>	<code>false</code>	If true, ask user if changes should be saved before the application is closed.
<code>startmode</code>	<code>edit   run</code>	<code>edit</code>	Determines whether the application is opened for editing or running when you double-click the MPH file, including Windows desktop icons.

### EXAMPLE CODE

```
app.set("asktosave", true);
```

The following code appends a text string to the application window title.

```
String oldTitle = app.mainWindow().getString("title");
app.mainWindow().set("title", oldTitle + " modified");
```

## Main Window

---

The `MainWindow` class has the following methods:

NAME	SYNTAX	DESCRIPTION
<code>menuBar</code>	<code>ItemList menuBar()</code>	Returns the list of items in the menu bar.
<code>menuBar</code>	<code>Item menuBar(String name)</code>	Returns the menu bar item with the specified name.
<code>toolBar</code>	<code>ItemList toolBar()</code>	Returns the list of items in the toolbar.

NAME	SYNTAX	DESCRIPTION
toolbar	Item toolbar(String name)	Returns the toolbar item with the specified name.
ribbon	ItemList ribbon()	Returns the list of items in the ribbon.
ribbon	Item ribbon(String name)	Returns the ribbon item with the specified name.
fileMenu	ItemList fileMenu()	Returns the list of items in the file menu.
fileMenu	Item fileMenu(String name)	Returns the file menu item with the specified name.
hasProperty	boolean hasProperty(String name)	Returns true if there is a modifiable property with the specified name.

The `MenuBar` and `ToolBar` items are visible in the application user interface if the menu type is set to **Menu bar** in the **Settings** window of the **Main Window**. The `Ribbon` and `FileMenu` items are visible in the user interface if the menu type is set to **Ribbon**. It is possible to access and modify items that are not visible based on the menu type setting, but doing so will not have any visible effect in the user interface.

The `MainWindow` class has the following properties:

PROPERTY	VALUE	DEFAULT	DESCRIPTION
showfilename	true   false	true	If true the filename is included in the window title bar title.
title	String	My application	The text to display in the window title bar.

## EXAMPLE CODE

```
app.mainWindow().set("showfilename", false);
```

## Form

The `Form` class has the following methods:

NAME	SYNTAX	DESCRIPTION
getName	String getName()	Returns the name of this form.
getParentForm	Form getParentForm()	Returns the parent form that contains this form. Useful for local cards in a card stack.

NAME	SYNTAX	DESCRIPTION
formObject	FormObjectList formObject()	Returns the list of form objects.
formObject	FormObject formObject(String name)	Returns the form object with the specified name.
hasProperty	boolean hasProperty(String name)	Returns true if there is a modifiable property with the specified name.
declaration	DataSource declaration(String name)	Returns a form declaration object (Scalar, Array 1D, Array 2D, or ChoiceList) with the specified name.
method	MethodList method()	Returns the list of methods.
method	Method method(String name)	Gets a method with the specified name.

The Form class has the following properties:

PROPERTY	VALUE	DEFAULT	DESCRIPTION
icon	String	""	The name of the background image. Valid values are images defined in Images>Libraries node in the application tree.
iconalign	left   center   right   fill   repeat	center	Horizontal alignment for the background image.
iconvalign	top   center   bottom   fill   repeat	center	Vertical alignment for the background image.
title	String	Form N	The form title for an integer N.

## EXAMPLE CODE

```
app.form("form1").set("icon", "compute.png");
app.form("form1").formObject("button1").set("enabled", false);
DataSource ds = app.form("form1").declaration("var");
```

## Form Object

---

The `FormObject` class has the following methods:

NAME	SYNTAX	DESCRIPTION
<code>getName</code>	<code>String getName()</code>	Returns the name of this form object.
<code>getParentForm</code>	<code>Form getParentForm()</code>	Returns the parent form that contains this form object.
<code>getType</code>	<code>String getType()</code>	Returns the form object type name, as defined in the following sections.
<code>getValue</code>	<code>Value getValue()</code>	Returns the current value of a <code>FormObject</code> when applicable. The method is supported by the following types of <code>FormObjects</code> : input field, toggle button, check box, combo box, file import, array input, radio button, selection input, text, list box, table, slider, knob.
<code>expanded</code>	<code>void expanded(String form, boolean expanded)</code>	Sets the expanded state of the form when using the sections type.
<code>form</code>	<code>FormList form()</code>	For a <code>CardStack</code> form object, returns the list of local cards.
<code>form</code>	<code>Form form(String name)</code>	For a <code>CardStack</code> form object, returns the local card with the specified name.
<code>item</code>	<code>ItemList item()</code>	For a <code>Toolbar</code> , <code>Graphics</code> or <code>Table</code> form object, returns the list of user-defined buttons.
<code>item</code>	<code>Item item(String name)</code>	For a <code>Toolbar</code> , <code>Graphics</code> or <code>Table</code> form object, return the user-defined button with the specified name.
<code>hasProperty</code>	<code>boolean hasProperty(String name)</code>	Returns true if there is a modifiable property with the specified name.
<code>visible</code>	<code>void visible(String form, boolean visible)</code>	Sets the visible state of the form.

Most form objects have one or more of the properties listed in “General Properties” on page 59. A form object has a certain property if the corresponding setting is available in the Form editor. Additional properties are supported for several types of form objects. The general properties that are supported and any additional properties for form objects are listed in the following sections.

### EXAMPLE CODE

The following code loops over all buttons and disables them:



```

for (FormObject formObject : app.form("form1").formObject()) {
    if ("Button".equals(formObject.getType())) {
        formObject.set("enabled", false);
    }
}

```

The `getType` method retrieves the type of form object. In the above example the type of form object is `Button` and the statement `"Button".equals(formObject.getType())` represents a string comparison between the output of the `getType` method and the string `"Button"`.

For an example of using `getValue`, see “Data Validation” on page 208.

The following table lists all form object types that can be returned by `getType`:

FORM OBJECT TYPE		
ArrayInput	Hyperlink	SelectionInput
Button	Image	Slider
CardStack	InformationCardStack	Spacer
CheckBox	InputField	Table
ComboBox	Knob	Text
DataDisplay	Line	TextLabel
Equation	ListBox	ToggleButton
FileImport	Log	Toolbar
Form	MessageLog	Unit
FormCollection	ProgressBar	Video
Gauge	RadioButton	WebPage
Graphics	ResultsTable	

## ARRAY INPUT

Property	Value	Default	Description
background			See “General Properties” on page 59.
enabled			
font			
fontbold			
fontitalic			
fontsize			
foreground			
visible			

### Example Code

```

app.form("form1").formObject("arrayinput1").set("enabled", false);

```

## BUTTON

PROPERTY	VALUE	DEFAULT	DESCRIPTION
enabled font fontbold fontitalic fontsize foreground visible			See "General Properties" on page 59.
icon	String	" "	The button icon. Valid values are images defined in "Images > Libraries" in the Application Builder.
text	String	Generated automatically	The button text. The text must not be an empty string.
tooltip	String	" "	The button tooltip text.

In the Form editor, if a button has its **Size** setting set to **Large**, it always displays its text property. If the button is **Small**, it either displays the **icon** or the **text** according to the following rule: if the **icon** property is empty, the **text** is displayed, if the **icon** property is not empty, the **icon** is displayed.

### Example Code

```
app.form("form1").formObject("button1").set("enabled", false);
```

## CARD STACK

PROPERTY	VALUE	DEFAULT	DESCRIPTION
enabled visible			See "General Properties" on page 59.

### Example Code

```
app.form("form1").formObject("cardstack1").set("visible", false);
```

To access objects in a local card, either use shortcuts or use the form method:

```
app.form("form1").formObject("cardstack1").form("card1")  
    .formObject("button1").set("enabled", false);
```

## CHECK BOX

PROPERTY	VALUE	DEFAULT	DESCRIPTION
background enabled font fontbold fontitalic fontsize fontunderline foreground visible			See "General Properties" on page 59.
text	String	Generated automatically	The check box label text.
tooltip	String	" "	The check box tooltip text.

### *Example Code*

```
app.form("form1").formObject("checkbox1").set("tooltip", "tooltip text");
```

## COMBO BOX

PROPERTY	VALUE	DEFAULT	DESCRIPTION
enabled font fontbold fontitalic fontsize foreground visible			See "General Properties" on page 59.

### *Example Code*

```
app.form("form1").formObject("combobox1").set("foreground", "blue");
```

## DATA DISPLAY

PROPERTY	VALUE	DEFAULT	DESCRIPTION
background enabled font fontbold fontitalic fontsize foreground visible			See "General Properties" on page 59.
exponent	superscript   E	superscript	When set to <b>superscript</b> , exponents are displayed using superscript font. When set to <b>E</b> , exponents are displayed using the character <b>E</b> followed by the exponent value.
notation	auto   scientific   decimal	auto	When the value is <b>scientific</b> , numbers are always displayed using scientific notation. When the value is <b>decimal</b> , numbers are never displayed using scientific notation. When the value is <b>auto</b> , the notation depends on the size of the number.
precision	Integer	4	The number of significant digits that are displayed.
showunit	true   false	true	Controls if the unit is displayed in addition to numerical values.
tooltip	String	" "	The tooltip text.

### Example Code

```
app.form("form1").formObject("datadisplay1")  
    .setColor("background", 192, 192, 192);
```

## EQUATION

PROPERTY	VALUE	DEFAULT	DESCRIPTION
<code>enabled</code> <code>fontsize</code> <code>foreground</code> <code>visible</code>			See "General Properties" on page 59.
<code>equation</code>	String		The string in LaTeX syntax defining the equation.

### Example Code

```
app.form("form1").formObject("equation1").set("visible", false);
```

## FILE IMPORT

PROPERTY	VALUE	DEFAULT	DESCRIPTION
<code>background</code> <code>enabled</code> <code>font</code> <code>fontbold</code> <code>fontitalic</code> <code>fontsize</code> <code>foreground</code> <code>visible</code>			See "General Properties" on page 59.
<code>buttontext</code>	String	Browse...	Text to display on the button that opens the file browser.
<code>dialogtitle</code>	String	File import	Text to display as dialog title for the file browser dialog. Also displayed as a tooltip for the <code>FileBrowser</code> form object.
<code>filetypes</code>	String[]	{"ALLFILES"}	Defines the list of file types that can be selected in the file browser.

### Example Code

```
app.form("form1").formObject("fileimport1")  
    .set("filetypes", new String[]{"ALL2DCAD"});
```

## FORM

A form used as a subform does not have any modifiable properties.

## FORM COLLECTION

PROPERTY	VALUE	DEFAULT	DESCRIPTION
enabled font fontbold fontitalic fontsize foreground visible			See "General Properties" on page 59.
formvisible	boolean[]	Array with each entry having the value <code>true</code>	Defines the visible state of forms in a form collection.
sectionexpanded	boolean[]	Array with each entry having the value <code>true</code>	Defines the expanded state of forms in a form collection when using the sections type.

To modify the active pane, change the corresponding declaration variable.

### *Example Code*

This line of code changes the font:

```
app.form("form1").formObject("collection1").set("font", "Arial");
```

The expanded state of sections in form collections can be controlled by:

```
app.form("form1").formObject("formcollection1").expanded("form2", false);
```

The `expanded` method is only supported by form collections which use sections. The first argument is the tag of the form which is represented by the section. The second argument determines if the sections should be expanded or collapsed.

## GRAPHICS

PROPERTY	VALUE	DEFAULT	DESCRIPTION
<code>enabled</code> <code>visible</code>			See "General Properties" on page 59.
<code>datapick</code>	<code>true</code>   <code>false</code>	<code>false</code>	If <code>true</code> , data picking is enabled in the graphics form object.
<code>datapicktarget</code>	<code>ProbeFeature</code>   <code>GraphicsData</code>		Defines where the picked data is stored. Valid values are probe features and <code>GraphicsData</code> declarations.
<code>source</code>	<code>ModelEntity</code>		Defines the type of model entity (Plot Group, Geometry, Mesh, Explicit Selection or Player Animation) used to plot in the graphics form object.

### Example Code

This line of code displays plot group 5 (`pg5`) in the graphics object `graphics1` in the form with the name `Temperature`:

```
app.form("Temperature").formObject("graphics1")
    .set("source", model.result("pg5"));
```

The following line of code using `useGraphics` is equivalent to the above example:

```
useGraphics(model.result("pg5"), "Temperature/graphics1");
```

Either method changes the source of the graphics form object and then plots the contents.

To clear the contents of a graphics object, use:

```
app.form("Temperature").formObject("graphics1")
    .set("source", (ModelEntity) null);
```

or equivalently

```
useGraphics(null, "Temperature/graphics1");
```

The code below displays the mesh in the model tree node `mesh1` in the graphics object `graphics1` contained in the card of a card stack:

```
app.form("mesh").formObject("cardstack1").form("card1")
    .formObject("graphics1").set("source", model.mesh("mesh1"));
```

The code below enables data picking for a graphics object and sets the data picking target to a domain point probe:

```
app.form("form1").formObject("graphics1").set("datapick", true);
app.form("form1").formObject("graphics1").set("datapicktarget",
    model.component("comp1").probe("pdom1"));
```

If a shortcut `graphics1` has been created for the graphics object and a shortcut `pdom1` has been created for the probe object, the above can be shortened to:

```
graphics1.set("datapick", true);
graphics1.set("datapicktarget", pdom1);
```

## HYPERLINK

PROPERTY	VALUE	DEFAULT	DESCRIPTION
background enabled font fontbold fontitalic fontsize visible			See "General Properties" on page 59.
text	String	Generated automatically	The text to display on the <b>HyperLink</b> form object.
url	String	""	The URL to open when the <b>HyperLink</b> is activated.

### Example Code

```
with (app.form("form1").formObject("hyperlink1"));
  set("text", "COMSOL");
  set("url", "www.comsol.com");
endwith();
```

## IMAGE

PROPERTY	VALUE	DEFAULT	DESCRIPTION
enabled visible			See "General Properties" on page 59.
icon	String	cube_large.png	Defines the icon name to display in the <b>Image</b> form object. Valid values are images defined in the <b>Images&gt;Libraries</b> node in the application tree.

### Example Code

```
app.form("form1").formObject("image1").set("icon", "compute.png");
```



## INFORMATION CARD STACK

PROPERTY	VALUE	DEFAULT	DESCRIPTION
background enabled font fontbold fontitalic fontsize fontunderline visible			See "General Properties" on page 59.

### *Example Code*

```
app.form("form1").formObject("infocard1").set("fontunderline", true);
```

## INPUT FIELD

PROPERTY	VALUE	DEFAULT	DESCRIPTION
background enabled font fontbold fontitalic fontsize foreground visible			See "General Properties" on page 59.
editable	true   false	true	If true then the text in the input field can be edited by the user.
exponent	superscript   E	superscript	When set to <b>superscript</b> , exponents are displayed using superscript font. When set to <b>E</b> , exponents are displayed using the character <b>E</b> followed by the exponent value.
inputformatting	on   off	off	If the value is <b>on</b> , then numerical values in the input field are formatted according to the exponent, notation and precision properties. When the user is editing the text in the input field, the formatting is temporarily disabled so that the original text can be edited.
maxdouble	double	1000	The maximum allowed double value. This property is only accessible when the Filter setting is set to Double and the corresponding check box is enabled in the Data Validation section.
mindouble	double	0	The minimum allowed double value. This property is only accessible when the Filter setting is set to Double and the corresponding check box is enabled in the Data Validation section.

PROPERTY	VALUE	DEFAULT	DESCRIPTION
<code>maxinteger</code>	Integer	1000	The maximum allowed integer value. This property is only accessible when the Filter setting is set to Integer and the corresponding check box is enabled in the Data Validation section.
<code>mininteger</code>	Integer	0	The minimum allowed integer value. This property is only accessible when the Filter setting is set to Integer and the corresponding check box is enabled in the Data Validation section.
<code>notation</code>	auto   scientific   decimal	auto	When the value is <b>scientific</b> , numbers are always displayed using scientific notation. When the value is <b>decimal</b> , numbers are never displayed using scientific notation. When the value is <b>auto</b> , the notation depends on the size of the number.
<code>precision</code>	Integer	4	The number of significant digits displayed.
<code>tooltip</code>	String	" "	The tooltip displayed when the mouse pointer is located over the input field.

### Example Code

```
app.form("form1").formObject("inputfield1").set("precision", 6);
```

## LINE

PROPERTY	VALUE	DEFAULT	DESCRIPTION
enabled font fontbold fontitalic fontsize foreground visible			See "General Properties" on page 59.
text	String	" "	Text to display on the line. The text is only displayed for horizontal lines that have Include divider text enabled in the Line object Settings window.
thickness	Integer	1	The line thickness.
linecolor	String	default	The line color.

### Example Code

```
app.form("form1").formObject("line1").set("text", "divider text");  
app.form("form1").formObject("line1").set("thickness", 10);  
app.form("form1").formObject("line1").set("linecolor", blue);
```

## LIST BOX

PROPERTY	VALUE	DEFAULT	DESCRIPTION
enabled font fontbold fontitalic fontsize foreground visible			See "General Properties" on page 59.

### Example Code

```
app.form("form1").formObject("listbox1").set("foreground", "red");
```

To change the list box contents, modify the corresponding choice list:

```
app.declaration("choicelist1").appendListRow("new value", "new name");
```

## LOG

PROPERTY	VALUE	DEFAULT	DESCRIPTION
background enabled font fontbold fontitalic fontsize foreground visible			See "General Properties" on page 59.

### *Example Code*

```
app.form("form1").formObject("log1").set("fontsize", "20");
```

## MESSAGE LOG

PROPERTY	VALUE	DEFAULT	DESCRIPTION
background enabled font fontbold fontitalic fontsize foreground visible			See "General Properties" on page 59.

### *Example Code*

```
app.form("form1").formObject("messages1").set("background", "gray");
```

## PROGRESS BAR

PROPERTY	VALUE	DEFAULT	DESCRIPTION
enabled visible			See "General Properties" on page 59.

To create and update progress information see "Progress Methods" on page 128.

### *Example Code*

```
app.form("form1").formObject("progressbar1").set("visible", false);
```

## RADIO BUTTON

PROPERTY	VALUE	DEFAULT	DESCRIPTION
background enabled font fontbold fontitalic fontsize fontunderline foreground visible			See "General Properties" on page 59.

To change the display name for a radio button, modify the value in the corresponding choice list.

For a choice list that is used by a radio button, it is not possible to change the value of any row, or to add or remove rows. Only the display name can be changed.

### Example Code

```
app.form("form1").formObject("radiobutton1").set("fontitalic", true);  
app.declaration("choicelist1").setDisplayNames("new name", 0);
```

## RESULTS TABLE

PROPERTY	VALUE	DEFAULT	DESCRIPTION
enabled font fontbold fontitalic fontsize foreground visible			See "General Properties" on page 59.
source	TableFeature		Set the contents of the results table.

To change the contents of the results table use the method `useResultsTable` or `evaluateToResultsTable`. See also "GUI-Related Methods" on page 114.

### Example Code

```
app.form("form1").formObject("resultstable1").set("visible", true);  
app.form("form1").formObject("resultstable1").set("source",  
    model.result().table("tbl2"));  
useResultsTable(model.result().table("tbl2"), "/form1/resultstable1");
```

## SELECTION INPUT

PROPERTY	VALUE	DEFAULT	DESCRIPTION
<code>active</code>	<code>true   false</code>	<code>false</code>	The <code>active</code> property controls whether the Selection Input is active. Changing the property value selects or deselects the Activate Selection button in the Selection Input.
<code>background</code> <code>enabled</code> <code>font</code> <code>fontbold</code> <code>fontitalic</code> <code>fontsize</code> <code>foreground</code> <code>visible</code>			See "General Properties" on page 59.
<code>graphics</code>	<code>FormObject</code>		Defines the graphics form object to use when the selection form object is active.
<code>source</code>	<code>SelectionFeature</code>		Defines the model selection the selection form object is connected to.

### Example Code

```
app.form("form1").formObject("selectioninput1").set("graphics",  
    "graphics1");
```

Alternatively, if there are shortcuts `se11` and `g1` to the `selectioninput1` and `graphics1` form objects:

```
se11.set("graphics", g1);
```

To change the model selection, assuming `se11` is a shortcut to the selection input form object:

```
se11.set("source", model.selection("sel2"));
```

## SLIDER

PROPERTY	VALUE	DEFAULT	DESCRIPTION
<b>enabled</b> <b>visible</b>			See "General Properties" on page 59.
<b>max</b>	Double	1	The largest possible slider value.
<b>min</b>	Double	0	The smallest possible slider value.
<b>steps</b>	Integer	5	The number of steps between the <b>min</b> and <b>max</b> values. The number of tick marks is one more than the number of steps.
<b>tooltip</b>	String	" "	The tooltip text.

The **min** value is allowed to be larger than the **max** value, in which case the slider behaves as if the values were swapped. The smallest value always corresponds to the left side of the slider.

### *Example Code*

```
app.form("form1").formObject("slider1").set("min", 1);  
app.form("form1").formObject("slider1").set("max", 12);  
app.form("form1").formObject("slider1").set("steps", 11);
```



## KNOB

PROPERTY	VALUE	DEFAULT	DESCRIPTION
background enabled font fontbold fontitalic fontsize foreground visible			See "General Properties" on page 59.
exponent	superscript   E	superscript	When set to <b>superscript</b> , exponents are displayed using superscript font. When set to <b>E</b> , exponents are displayed using the character <b>E</b> followed by the exponent value.
knobmaincolor	String	default	The main background color.
knobradius	Integer		When <b>knobradiusmanual</b> has the value <b>on</b> , this is the value of the knob. The tick marks appear outside this radius.
knobradiusmanual	on   off	off	When the value is <b>off</b> the radius is calculated automatically. When the value is <b>on</b> , the radius is given by the <b>knobradius</b> property.
knobsecondarycolor	String	default	The secondary background color.
labelformatting	true   false	false	When <b>true</b> this setting enables custom label formatting.
max	Double	1	The largest possible knob value.
min	Double	0	The smallest possible knob value.
mouse	distance   vertical   circular	distance	The kind of mouse movement to change the knob value. When set to <b>distance</b> , the distance the mouse is moved, either horizontally or vertically, controls the value. When set to <b>vertical</b> , only the vertical distance the mouse is moved controls the value. When set to <b>circular</b> , the value is changed using a circular motion.
needlecolor	String	default	The color of the knob's needle.

PROPERTY	VALUE	DEFAULT	DESCRIPTION
notation	auto   scientific   decimal	auto	When the value is <b>scientific</b> , numbers are always displayed using scientific notation. When the value is <b>decimal</b> , numbers are never displayed using scientific notation. When the value is <b>auto</b> , the notation depends on the size of the number.
precision	Integer	4	The number of significant digits that are displayed.
scale	none   marks   markslabels   marksalllabels	marks	To control whether the scale should have tick marks or labels. When set to <b>none</b> , the knob has no tick marks or labels. When set to <b>marks</b> , the knob has tick marks but no labels. When set to <b>markslabels</b> , the knob has tick marks and labels for the minimum and maximum values. When set to <b>marksalllabels</b> , the knob has ticks marks and all major ticks has a label.
steps	Integer	5	The number of steps between the <b>min</b> and <b>max</b> values. The number of tick marks is one more than the number of steps.
tooltip	String	""	The tooltip text.

### Example Code

```
app.form("form1").formObject("knob1").set("min", 1);
app.form("form1").formObject("knob1").set("max", 12);
app.form("form1").formObject("knob1").set("steps", 11);
```

### SPACER

A spacer object does not have any modifiable properties.

## TABLE

PROPERTY	VALUE	DEFAULT	DESCRIPTION
<code>enabled</code> <code>font</code> <code>fontbold</code> <code>fontitalic</code> <code>fontsize</code> <code>foreground</code> <code>visible</code>			See "General Properties" on page 59.
<code>headers</code>	<code>String[]</code>	Generated automatically	Column headers.
<code>showheaders</code>	<code>boolean</code>	Generated automatically	Show column headers.

To change the contents of the table, change the declaration variables or model entities the table is displaying.

### Example Code

```
app.form("form1").formObject("table1").set("enabled", false);
```

## TEXT

PROPERTY	VALUE	DEFAULT	DESCRIPTION
<code>background</code> <code>enabled</code> <code>font</code> <code>fontbold</code> <code>fontitalic</code> <code>fontsize</code> <code>foreground</code> <code>visible</code>			See "General Properties" on page 59.
<code>editable</code>	<code>on   off</code>	<code>off</code>	If the value is <code>on</code> , the text can be edited by the user of the application. If the value is <code>off</code> , the text can only be changed programmatically.
<code>textalign</code>	<code>left   center   right</code>	<code>left</code>	Defines how the text is aligned within the text area.
<code>wrap</code>	<code>on   off</code>	<code>on</code>	If the value is <code>on</code> , word wrapping is used to break lines that are too long to fit within the text area. If the value is <code>off</code> , long lines may not be completely visible.

### Example Code

```
app.form("form1").formObject("text1").set("textalign", "center");
```

## TEXT LABEL

PROPERTY	VALUE	DEFAULT	DESCRIPTION
background enabled font fontbold fontitalic fontsize fontunderline foreground visible			See "General Properties" on page 59.
text	String	Generated automatically	The text to display in the label when the label is not in multiline mode.
textmulti	String	Generated automatically	The text to display in the label when the label is in multiline mode.

### Example Code

```
app.form("form1").formObject("textlabel1").set("text", "custom text");
```

## TOGGLE BUTTON

PROPERTY	VALUE	DEFAULT	DESCRIPTION
enabled font fontbold fontitalic fontsize foreground visible			See "General Properties" on page 59.
icon	String	""	The button icon. Valid values are images defined in "Images>Libraries" in the Application Builder.
text	String	Generated automatically	The button text. The text must not be an empty string.
tooltip	String	""	The button tooltip text.

A button with size large always displays the text, a button with size small displays either the icon or the text. If the icon property is empty, the text is displayed. If the icon property is not empty, the icon is displayed.

### Example Code

```
app.form("form1").formObject("togglebutton1").set("icon",  
"about_information.png");
```

## TOOLBAR

PROPERTY	VALUE	DEFAULT	DESCRIPTION
background enabled font fontbold fontitalic fontsize foreground visible			See "General Properties" on page 59.

### Example Code

```
app.form("form1").formObject("toolbar1").set("background", "gray");
```

## UNIT

PROPERTY	VALUE	DEFAULT	DESCRIPTION
background enabled font fontbold fontitalic fontsize foreground visible			See "General Properties" on page 59.

### Example Code

```
app.form("form1").formObject("unit1").set("visible", false);
```

## VIDEO

PROPERTY	VALUE	DEFAULT	DESCRIPTION
visible			See "General Properties" on page 59.

### Example Code

```
app.form("form1").formObject("video1").set("visible", false);
```

## WEB PAGE

PROPERTY	VALUE	DEFAULT	DESCRIPTION
visible			See "General Properties" on page 59.
file	String		The file to display. File scheme syntax is supported.
html	String	<html></html>	The HTML code to display.
report	ReportFeature or String		The report feature to display.
type	page   url   report type   report	page	Determines which property is used to specify the browser display contents.
url	String	https://www.comsol.com	The URL to display.

### Example Code

```
app.form("form1").formObject("webpage1").set("type", "report");
app.form("form1").formObject("webpage1").set("report", "rpt1");
model.result().report("rpt1");
model.result().report("rpt1").run();
```

## Item

Item objects represent items, toggle items, user defined buttons in Toolbar, Graphics and Table form objects, and submenus in the menu bar, toolbar, ribbon and file menu. The following methods are available:

NAME	SYNTAX	DESCRIPTION
item	ItemList item()	Returns the list of subitems.
item	Item item(String name)	Returns the subitem with the specified name.
getParentItem	Item getParentItem()	Returns the parent item, or null for a top-level item.
hasProperty	boolean hasProperty(String name)	Returns true if there is a modifiable property with the specified name.

The `Item` class contains the following properties:

PROPERTY	VALUE	DEFAULT	DESCRIPTION
<code>enabled</code>	<code>on</code>   <code>off</code>	<code>on</code>	If the value is <code>on</code> , the item can be activated by the user. If the value is <code>off</code> , the item cannot be activated.
<code>icon</code>	String	Generated automatically	The icon name. Valid values are images defined in <b>Images &gt; Libraries in the Application Builder</b> .
<code>text</code>	String	Generated automatically	The text for a menu or ribbon item.
<code>title</code>	String	Generated automatically	The title text for a menu or submenu.
<code>tooltip</code>	String	" "	The tooltip text.
<code>visible</code>	<code>on</code>   <code>off</code>	<code>on</code>	Controls whether the item is visible or not.

In order for an item to be enabled, the `enabled` property needs to have the value `on` for the item itself as well as for all of its parents. In other words, disabling an item also disables all of its subitems.

Item objects also include separators. However, separators do not have any accessible properties.

Item objects for user-defined buttons do not have the `title` and `tooltip` properties. For Table form objects, predefined items such as “move up” and “move down” do not have any modifiable properties.

#### EXAMPLE CODE

```
app.mainWindow().menuBar("menu1").set("title", "new title");
app.mainWindow().menuBar("menu1").item("toggle_item1").set("text",
    "test");
```

## Data Source

---

A `DataSource` object is either a `Scalar`, `Array 1D`, `Array 2D`, `ChoiceList` a `UnitSet` or a `GraphicsData`.

## SCALAR, ARRAY 1D, AND ARRAY 2D METHODS

The methods described in the following table are applicable for `Scalar`, `Array 1D`, and `Array 2D` objects (of types `String`, `Boolean`, `Integer`, `Double`). These methods are used to manipulate such variable objects during runtime.

NAME	SYNTAX	DESCRIPTION
<code>getBoolean</code>	<code>boolean getBoolean()</code>	Gets the Boolean value stored in the data source.
<code>getBooleanArray</code>	<code>boolean[] getBooleanArray()</code>	Gets the Boolean array value stored in the data source.
<code>getBooleanMatrix</code>	<code>boolean[][] getBooleanMatrix()</code>	Gets the Boolean matrix value stored in the data source.
<code>getDouble</code>	<code>double getDouble()</code>	Gets the double value stored in the data source.
<code>getDoubleArray</code>	<code>double[] getDoubleArray()</code>	Gets the double array value stored in the data source.
<code>getDoubleMatrix</code>	<code>double[][] getDoubleMatrix()</code>	Gets the double matrix value stored in the data source.
<code>getInt</code>	<code>int getInt()</code>	Gets the int value stored in the data source.
<code>getIntArray</code>	<code>int[] getIntArray()</code>	Gets the int array value stored in the data source.
<code>getIntMatrix</code>	<code>int[][] getIntMatrix()</code>	Gets the int matrix value stored in the data source.
<code>getString</code>	<code>String getString()</code>	Gets the String value stored in the data source.
<code>getStringArray</code>	<code>String[] geStringArray()</code>	Gets the String array value stored in the data source.
<code>getStringMatrix</code>	<code>String[][] getStringMatrix()</code>	Gets the String matrix value stored in the data source.
<code>set</code>	<code>set(boolean value)</code> <code>set(boolean[] value)</code> <code>set(boolean[][] value)</code> <code>set(double[] value)</code> <code>set(double[] value)</code> <code>set(double[][] value)</code> <code>set(int value)</code> <code>set(int[] value)</code> <code>set(int[][] value)</code> <code>set(String value)</code> <code>set(String[] value)</code> <code>set(String[][] value)</code>	Set the value stored in the data source. Available methods depend on the type of the underlying declaration.



## EXAMPLE CODE

```
// Get a scalar double declaration.
DataSource ds = app.declaration("var");
// The 'var' declaration is a scalar double so we use the getDouble method
// to read its value.
double cur = ds.getDouble();
// Modifying the local field 'cur' does not affect the value stored in the
// data source 'ds'.
cur = cur + 1;
// Set the value of the data source.
ds.set(cur);
```

## CHOICE LIST AND UNIT SET METHODS

The methods described in the following table are applicable for both `ChoiceList` and `UnitSet` objects. These methods are used to manipulate choice lists and unit sets during runtime.

NAME	SYNTAX	DESCRIPTION
<code>setListRow</code>	<code>setListRow(String value, String displayName, int row)</code>	Sets the value and display name for the given row (0-based). If the row is equal to the length of the list, a new row is added.
<code>setList</code>	<code>setList(String[] values, String[] displayNames)</code>	Sets all of the values and display names, replacing the contents of the choice list or unit set.
<code>setValue</code>	<code>setValue(String value, int row)</code>	Sets the value for the given row (0-based). If the row is equal to the length of the list, a new row is added with the value and an empty display name.
<code>setDisplayName</code>	<code>setDisplayName(String displayName, int row)</code>	Sets the display name for the given row (0-based). If the row is equal to the length of the list, a new row is added with the display name and an empty value.
<code>getValue</code>	<code>String getValue(int row)</code>	Returns the value for the given row (0-based).
<code>getDisplayName</code>	<code>String getDisplayName(int row)</code>	Returns the display name for the given row (0-based).
<code>getDisplayValue</code>	<code>String getDisplayValue(String value)</code>	Returns the display name for the row with the given value.
<code>getValues</code>	<code>String[] getValues()</code>	Returns all values as an array.

NAME	SYNTAX	DESCRIPTION
<code>getDisplayNames</code>	<code>String[] getDisplayNames()</code>	Returns all display names as an array.
<code>addListRow</code>	<code>addListRow(String value, String displayName, int row)</code>	Inserts a new row with the given value and display name at the specified row (0-based).
<code>appendListRow</code>	<code>appendListRow(String value, String displayName)</code>	Inserts a new row with the given value and display name at the end of the list.
<code>removeListRow</code>	<code>removeListRow(int row)</code>	Removes the given row (0-based) from the list.

### Example Code

The code below adds the string Aluminum 3004 to a choice list. Note that the choice list index starts at 0, whereas the material tags start at 1 (`mat1`, `mat2`, `mat3`, and `mat4`).

```
ChoiceList choiceList = getChoiceList("choicelist1");
choiceList.setListRow("mat4", "Aluminum 3004", 3);
```

For more information on using choice lists for changing materials, see the book *Introduction to Application Builder*.

## UNIT SET METHODS

When the object is a `UnitSet` the following additional methods are also available:

NAME	SYNTAX	DESCRIPTION
<code>set</code>	<code>set(String value)</code>	Switch unit for the unit set.
<code>getString</code>	<code>String getString()</code>	Returns the currently selected value for the unit set.
<code>getString</code>	<code>String getString(String unitList)</code>	Returns the selected unit for the given unit list.

## GRAPHICS DATA METHODS

When the object is a `GraphicsData` the following methods are available:

NAME	SYNTAX	DESCRIPTION
<code>set</code>	<code>set(String name, String value)</code> <code>set(String name, double value)</code> <code>set(String name, double[] value)</code>	Sets a new value for the property with the specified name.
<code>getString</code>	<code>String getString(String name)</code>	Returns the value of the specified property as a string.

NAME	SYNTAX	DESCRIPTION
<code>getDouble</code>	<code>double getDouble(String name)</code>	Returns the value of the specified property as a double value.
<code>getDoubleArray</code>	<code>double[] getDoubleArray(String name)</code>	Returns the value of the specified property as a double array value.

The `GraphicsData` class has the following properties:

PROPERTY	VALUE	DEFAULT	DESCRIPTION
<code>coord</code>	<code>double[]</code>	<code>0, 0, 0</code>	Point location of picked data. Array of 1, 2, 3 or 6 elements, corresponding to 1D, 2D, 3D, or Smith plot, respectively.
<code>depth</code>	<code>double</code>	<code>0</code>	Point along a line when data picking in a domain. Valid values are between 0 and 1, inclusive.
<code>edim</code>	<code>domain   boundary</code>	<code>domain</code>	Geometric entity level.
<code>eval</code>	<code>double</code>	<code>0</code>	Evaluated value of picked data.
<code>method</code>	<code>pointnormal   pointdir   twopoints   none</code>	<code>pointnormal</code>	Method of selecting a point in a 3D geometry.
<code>twopoint</code>	<code>first   second</code>	<code>first</code>	Point being picked in the <code>twopoints</code> line entry method.

### *Example code*

The following code enables data picking for the `graphics1` object, connects it to the `graphicsdata1` object and sets some properties on the `graphicsdata1` object:

```
app.form("form1").formObject("graphics1").set("datapick", true);
app.form("form1").formObject("graphics1").set("datapicktarget",
    app.declaration("graphicsdata1"));
app.declaration("graphicsdata1").set("edim", "boundary");
app.declaration("graphicsdata1").set("method", "pointdir");
```

## **AppEvent Class**

The `AppEvent` class contains information regarding an application user-interface events. The event field, accessible in application methods, is initialized with an

instance of this class when a `FormObject` event is being triggered. The `getUserControl` method retrieves the `FormObject` where the event originated.

NAME	SYNTAX	DESCRIPTION
<code>getNewValue</code>	<code>Value getNewValue()</code>	New value corresponding to a form object having an <code>On data change</code> event type.
<code>getOldValue</code>	<code>Value getOldValue()</code>	Old value corresponding to a form object having an <code>On data change</code> event type.
<code>getUserControl</code>	<code>IPropertyAccess getUserControl()</code>	To make it convenient to access a user control that triggered an event the method <code>event.getUserControl</code> returns the form or form object that triggered the event. The return type of the methods is <code>IPropertyAccess</code> and the object can be cast to an instance of the <code>FormObject</code> or <code>Form</code> class depending on what type of event is triggered.

## VALUE CLASS

The methods `getNewValue` and `getOldValue` returns an object of type `Value` which has methods according to the table below. The `Value` class represents a value which can be retrieved in different formats depending on the form object. For example, an event triggered from an input field is a scalar variable (`boolean`, `int`, `double`, or `String`). This means that only a subset of the methods in the table below is valid for a particular form object event.

NAME	SYNTAX	DESCRIPTION
<code>getBoolean</code>	<code>boolean getBoolean()</code>	Gets the Boolean value.
<code>getBooleanArray</code>	<code>boolean[] getBooleanArray()</code>	Gets the Boolean array value.
<code>getBooleanMatrix</code>	<code>boolean[][] getBooleanMatrix()</code>	Gets the Boolean matrix value.
<code>getDouble</code>	<code>double getDouble()</code>	Gets the double value.
<code>getDoubleArray</code>	<code>double[] getDoubleArray()</code>	Gets the double array value.
<code>getDoubleMatrix</code>	<code>double[][] getDoubleMatrix()</code>	Gets the double matrix value.
<code>getInt</code>	<code>int getInt()</code>	Gets the int value.
<code>getIntArray</code>	<code>int[] getIntArray()</code>	Gets the int array value.
<code>getIntMatrix</code>	<code>int[][] getIntMatrix()</code>	Gets the int matrix value.
<code>getString</code>	<code>String getString()</code>	Gets the string value.

NAME	SYNTAX	DESCRIPTION
<code>getStringArray</code>	<code>String[] getStringArray()</code>	Gets the string array value.
<code>getStringMatrix</code>	<code>String[][] getStringMatrix</code>	Gets the string matrix value.

The following code exemplifies using the event field, for the class `AppEvent`, and the methods `getNewValue` and `getOldValue`:

```
String value = event.getNewValue().getString();
String oldValue = event.getOldValue().getString();
```

For an example of using the event field and its associated methods, see “Data Validation” on page 208.

## Method Class

The `Method` class is used to represent a method. The following method is available for a `Method` object:

NAME	SYNTAX	DESCRIPTION
<code>run</code>	<code>Object run(Object... input)</code>	Run the method with the specified input parameters.

The following code exemplifies using a `Method` object:

```
// Get a Method object representing a Form Method.
Method m = app.form("form1").method("method1");
// The method takes a String parameter and returns a double.
double res = (Double) m.run("input");
```

## Form, Form Object, and Item List Methods

The `FormList`, `FormObjectList`, and `ItemList` classes have the following methods:

NAME	SYNTAX	PURPOSE
<code>names</code>	<code>String[] names()</code>	Returns an array of names for all objects in the list.
<code>size</code>	<code>int size()</code>	Returns the number of objects in the list.
<code>index</code>	<code>int index(String name)</code>	Returns the 0-based position of the object with a given name in the list.

NAME	SYNTAX	PURPOSE
get	Form get(String name) FormObject get(String name) Item get(String name)	Returns the object with a given name.
get	Form get(int index) FormObject get(int index) Item get(int index)	Returns the object at a certain index.

Additionally the FormList class has the following methods:

NAME	SYNTAX	PURPOSE
hasProperty	boolean hasProperty(String name)	Returns true if there is a modifiable property with the specified name.

It is also possible to use a list in an enhanced for loop to operate on all objects in the list.

In the following example, the background color is set to red in all forms, by looping over all forms:

```
for (Form f : app.form()) { // app.form() is of type FormList
    f.set("background", "red");
}
```

# The Built-in Method Library for the Application Builder

---

This section lists built-in methods available in the Method Editor in addition to the methods that operate on the model and application objects. For more information on the model object and its methods, refer to earlier sections of this book and the *Programming Reference Manual*. For more information on the application object, see “The Application Object” on page 55. Some of the listings have associated example code but for more extensive programming examples, see “Programming Examples” on page 153.

The syntax rules are those of the Java<sup>®</sup> programming language. Note that each line of code needs to end with a semicolon (;), but the semicolon is omitted in the listings below.

## Model Utility Methods

---

The following table summarizes the model utility methods for querying, creating, loading, and saving model objects. The model object is stored on the MPH file format.

NAME	SYNTAX	DESCRIPTION
<code>clearModel</code>	<code>clearModel(Model model)</code> <code>clearModel(String tag)</code>	Remove everything from the model except for the application part and the things you can change on the root node in the Model Builder, such as thumbnail, comment and author.
<code>createModel</code>	<code>Model createModel(String tag)</code>	Creates a new model with the given tag.
<code>createModel</code>	<code>Model createModel()</code>	Create a new model with a unique tag.
<code>getModel</code>	<code>Model getModel(String tag)</code>	Returns the model with a specified tag.
<code>loadModel</code>	<code>Model loadModel(String tag, String filename)</code>	Loads a model with a specified tag from a file.
<code>loadModel</code>	<code>Model loadModel(String filename)</code>	Loads a model from a file. The model is given a unique tag.
<code>loadProtectedModel</code>	<code>Model loadProtectedModel(String tag, String filename, String password)</code>	Loads a password protected model with a specified tag from a file.

NAME	SYNTAX	DESCRIPTION
loadProtectedModel	Model loadProtectedModel(String filename, String password)	Loads a password protected model from a file. The model is given a unique tag.
loadRecoveryModel	Model loadRecoveryModel(String tag, String foldername)	Loads a model from a recovery directory/folder structure.
loadRecoveryModel	Model loadRecoveryModel(String foldername)	Loads a model from a recovery directory/folder structure. The model is given a unique tag.
modelTags	String[] modelTags()	Returns an array of model tags for all loaded models, including the embedded model.
removeModel	removeModel(String tag) removeModel(Model model)	Removes a model. The embedded model cannot be removed.
saveModel	saveModel(Model model, String filename)	Saves a model to a file. The filename can be a file scheme path or (if allowed by security settings) a server file path.
uniqueModeltag	String uniqueModeltag(String prefix)	Returns a model tag that is not in use.
getComsolVersion	getComsolVersion()	Returns the current software version as a string.

### Example Code

The code below loads a model using `loadModel`, presented in the table above. It extracts the  $x$ -,  $y$ -, and  $z$ -coordinates of all mesh nodes and stores them in a 2D double array `coords[3][N]`, where  $N$  is the number of mesh nodes. The individual  $x$ -,  $y$ -, and  $z$ - coordinates are available as the length- $N$  1D arrays `coords[0]`, `coords[1]`, `coords[2]`, respectively. (The node locations can be plotted by using the Cut Point 3D dataset in combination with a 3D Point Trajectories plot.)

```
Model extmodel = loadModel("C:\\Paul\\pacemaker_electrode.mph");
SolverFeature step = extmodel.sol("sol1").feature("v1");
XmeshInfo xmi = step.xmeshInfo();
XmeshInfoNodes nodes = xmi.nodes();
double[][] coords = nodes.coords();
```

For more information on methods operating on the model object, see the *Programming Reference Manual*.

Note that to make the code above platform independent for use in an application you can instead use the common application file folder:

```
Model extmodel = loadModel("common:///pacemaker_electrode.mph");
```



## License Methods

---

The license methods read the license number and check out or test the licenses of the current session or for an MPH file. This functionality can be used, for example, to limit the use of an application to one or a few license numbers or to dynamically adapt functionality of an application depending on which product licenses are available.

NAME	SYNTAX	DESCRIPTION
<code>checkoutLicense</code>	<code>boolean checkoutLicense(String... product)</code>	Checks out licenses for all specified products. If not all licenses can be checked out, no licenses are checked out.
<code>checkoutLicenseForFile</code>	<code>boolean checkoutLicenseForFile(String file)</code>	Checks out licenses required to use a given MPH file. If not all required licenses can be checked out, no licenses are checked out.
<code>checkoutLicenseForFileOnServer</code>	<code>boolean hasLicenseForFileOnServer(String file);</code>	Checks out licenses required to use a given MPH file. If not all required licenses can be checked out, no licenses are checked out.
<code>getLicenseNumber</code>	<code>String license = getLicenseNumber()</code>	Returns a string with the license number for the current session.
<code>hasProduct</code>	<code>boolean hasProduct(String... product)</code>	Returns true if the COMSOL installation contains the software components required for running the specified products. Code completion can be used to get a list of valid product names.
<code>hasProductForFile</code>	<code>boolean hasProductForFile(String file)</code>	Returns true if the COMSOL installation contains the software components required for running the products required by a given MPH file.
<code>hasProductForFileOnServer</code>	<code>boolean checkoutLicenseForFileOnServer(String file);</code>	Returns true if the COMSOL installation contains the software components required for running the products required by a given MPH file.

## EXAMPLE CODE

The following code tries to check out a license for the AC/DC Module, and displays an error message if it fails:

```
if (!checkoutLicense("ACDC"))  
    alert("There seems to be a problem. Please contact Alice and Bob at  
    123-456-7890.");
```

You can use this to customize license error messages by calling a method containing this code before any add-on product specific features are used by the application.

In the Application Builder root node you can further select the **Ignore license errors during launch** check box. This will make it possible for users to start an application regardless of which licenses are available. However, this will not work if the application, at startup, uses features required by an add-on product. The application has to be created in such a way that the add-on product specific features are not used in the startup phase of the application but instead are deferred to later in the workflow.

To emulate a scenario where there are not enough available licenses you can, for example, disable one or more products in the **Licensed and Used Products in Session** dialog box, available from the **File** menu in the COMSOL Desktop environment.

The following code tests if the COMSOL installation has the capability to use an MPH file:

```
boolean ok = hasProductForFile("model_file.mph");
```

Note that even if `hasProductForFile` return true, in a floating network license situation there may not be any free licenses to check out. If your application is going to process several MPH files and you want to make sure all licenses are checked out before the processing starts, instead use the `checkoutLicense` or `checkoutLicenseForFile` methods.

## LICENSE FEATURE STRINGS

The following table contains the product strings for all add-on products in the COMSOL 5.6 product suite that can be used by the method `checkoutLicense`:

PRODUCT/FEATURE	FEATURE NAME
AC/DC Module	ACDC
Acoustics Module	ACOUSTICS
Battery Design Module	BATTERYDESIGN
CAD Import Module	CADIMPORT
CFD Module	CFD

PRODUCT/FEATURE	FEATURE NAME
Chemical Reaction Engineering Module	CHEM
Corrosion Module	CORROSION
Design Module	DESIGN, CADIMPORT
ECAD Import Module	ECADIMPORT
Electrochemistry Module	ELECTROCHEMISTRY
Electrodeposition Module	ELECTRODEPOSITION
Fatigue Module	FATIGUE
File Import for CATIA V5	CATIA5
Fuel Cell & Electrolyzer Module	FUELCELLANDELECTROLYZER
Geomechanics Module	GEOMECHANICS
Heat Transfer Module	HEATTRANSFER
Liquid & Gas Properties Module	LIQUIDANDGASPROPERTIES
LiveLink™ for AutoCAD®	LLAUTOCAD, CADIMPORT
LiveLink™ for PTC® Creo® Parametric™	LLCREOPARAMETRIC, CADIMPORT
LiveLink™ for Excel®	LLEXCEL
LiveLink™ for Inventor®	LLINVENTOR, CADIMPORT
LiveLink™ for MATLAB®	LLMATLAB
LiveLink™ for Revit®	LLREVIT, CADIMPORT
LiveLink™ for PTC® Pro/ENGINEER®	LLPROENGINEER, CADIMPORT
LiveLink™ for Simulink®	LLSIMULINK
LiveLink™ for Solid Edge®	LLSOLIDEDGE, CADIMPORT
LiveLink™ for SOLIDWORKS®	LLSOLIDWORKS, CADIMPORT
Material Library	MATLIB
MEMS Module	MEMS
Metal Processing Module	METALPROCESSING
Microfluidics Module	MICROFLUIDICS
Mixer Module	MIXER
Molecular Flow Module	MOLECULARFLOW
Multibody Dynamics Module	MULTIBODYDYNAMICS
Nonlinear Structural Materials Module	NONLINEARSTRUCTMATERIALS
Optimization Module	OPTIMIZATION
Particle Tracing Module	PARTICLETRACING

PRODUCT/FEATURE	FEATURE NAME
Pipe Flow Module	PIPEFLOW
Plasma Module	PLASMA
Polymer Flow Module	POLYMERFLOW
Porous Media Flow Module	POROUSMEDIAFLOW
Ray Optics Module	RAYOPTICS
RF Module	RF
Rotordynamics Module	ROTORDYNAMICS
Semiconductor Module	SEMICONDUCTOR
Structural Mechanics Module	STRUCTURALMECHANICS
Subsurface Flow Module	SUBSURFACEFLOW
Uncertainty Quantification Module	UQ
Wave Optics Module	WAVEOPTICS

## File Methods

File methods are used to read and write data to a file or portions of a file. Note that higher-level techniques for reading and writing to files are available from within the Application Builder user interface. For more information, see the book *Introduction to Application Builder* and “GUI Command Methods” on page 125.

NAME	SYNTAX	DESCRIPTION
<code>readFile</code>	<code>String readFile(String name)</code>	Returns the contents in the given file <code>name</code> as a string. The string <code>name</code> is the absolute path to a file or a path given by the file scheme syntax.
<code>openFileStreamReader</code>	<code>CsReader openFileStreamReader(String name)</code>	Returns a <code>CsReader</code> that can be used to read line-by-line or character-by-character from the given file <code>name</code> .
<code>openBinaryFileStreamReader</code>	<code>CsBinaryReader openBinaryFileStreamReader(String name)</code>	Returns a <code>CsBinaryReader</code> that can be used to read from the given file byte-by-byte.

NAME	SYNTAX	DESCRIPTION
<code>readMatrixFromFile</code>	<code>double[][]</code> <code>readMatrixFromFile(String name)</code>	Reads the contents of the given file into a double matrix. The file has the same spreadsheet type format as available in the model tree Export node.
<code>readStringMatrixFromFile</code>	<code>String[][]</code> <code>readStringMatrixFromFile(String name)</code>	Reads the contents of the given file into a string matrix. The file has the same spreadsheet type format as available in the model tree Export node.
<code>readCSVFile</code>	<code>String[][]</code> <code>readCSVFile(String name)</code>	Reads a file with comma-separated values (CSV file) into a string matrix. Expects file to use the RFC 4180 format for CSV.
<code>writeFile</code>	<code>writeFile(String name, String contents)</code>	Writes the given string contents to the given file name.
<code>writeFile</code>	<code>writeFile(String name, String contents, boolean append)</code>	Writes the given string contents to the given file name. If <code>append</code> is true, then the contents are appended instead of overwritten.
<code>writeFile</code>	<code>writeFile(String name, double[][] data)</code>	Writes the array data to the given file. The spreadsheet format is used, which means it can be read by <code>readMatrixFromFile</code> .
<code>writeFile</code>	<code>writeFile(String name, double[][] data, boolean append)</code>	Writes the array data to the given file. The spreadsheet format is used, which means it can be read by <code>readMatrixFromFile</code> . If <code>append</code> is true, then the contents are appended instead of overwritten.
<code>writeFile</code>	<code>writeFile(String name, String[][] data)</code>	Writes the array data to the given file. The spreadsheet format is used, which means it can be read by <code>readStringMatrixFromFile</code> .

NAME	SYNTAX	DESCRIPTION
<code>writeFile</code>	<code>writeFile(String name, String[][] data, boolean append)</code>	Writes the array <b>data</b> to the given file. The spreadsheet format is used, which means it can be read by <code>readStringMatrixFromFile</code> . If <b>append</b> is true, then the contents are appended instead of overwritten.
<code>openFileStreamWriter</code>	<code>CsWriter openFileStreamWriter(String name)</code>	Returns a <code>CsWriter</code> that can write to the given file.
<code>openFileStreamWriter</code>	<code>CsWriter openFileStreamWriter(String name, boolean append)</code>	Returns a <code>CsWriter</code> that can write to the given file. If <b>append</b> is true, then the contents are appended instead of overwritten.
<code>openBinaryFileStreamWriter</code>	<code>CsBinaryWriter openBinaryFileStreamWriter(String name)</code>	Returns a <code>CsBinaryWriter</code> that can be used to write to the given file byte-by-byte.
<code>openBinaryFileStreamWriter</code>	<code>CsBinaryWriter openBinaryFileStreamWriter(String name, boolean append)</code>	Returns a <code>CsBinaryWriter</code> that can be used to write to the given file byte by byte. If <b>append</b> is true, then the contents are appended instead of overwritten.
<code>writeCSVFile</code>	<code>writeCSVFile(String name, String[][] data)</code>	Writes the given string array <b>data</b> to a CSV file. The RFC 4180 format is used for the CSV.
<code>writeCSVFile</code>	<code>writeCSVFile(String name, String[][] data, boolean append)</code>	Writes the given string array <b>data</b> to a CSV file. The RFC 4180 format is used for the CSV. If <b>append</b> is true, then the contents are appended instead of overwritten.
<code>writeCSVFile</code>	<code>writeCSVFile(String name, double[][] data)</code>	Writes the given double array <b>data</b> to a CSV file. The RFC 4180 format is used for the CSV.
<code>writeCSVFile</code>	<code>writeCSVFile(String name, double[][] data, boolean append)</code>	Writes the given double array <b>data</b> to a CSV file. The RFC 4180 format is used for the CSV. If <b>append</b> is true, then the contents are appended instead of overwritten.

NAME	SYNTAX	DESCRIPTION
<code>exists</code>	<code>boolean exists(String name)</code>	<p>Tests whether a file with the given <b>name</b> exists.</p> <p>If the <b>name</b> is not a file scheme path name or an absolute path, then the method first finds out whether a file with file scheme path <b>embedded:///</b> + argument exists. If such a file does not exist, then it tests whether there is a file with a matching <b>name</b> in the current working directory.</p>
<code>deleteFile</code>	<code>deleteFile(String file)</code>	Delete a file with the given name if it exists. The file is deleted on the server,. The name can use a file scheme path.
<code>copyFile</code>	<code>copyFile(String sourceFile, String destFile)</code>	Copies a file on the server. Both the source and target names can use file scheme paths.
<code>importFile</code>	<code>importFile(String name)</code> <code>importFile(String name, String[] fileTypes)</code>	Displays a file browser dialog box and uploads the selected file to the file declaration with the given <b>name</b> . After this, the uploaded file can be accessed with <b>upload:///&lt;name&gt;</b> . The optional <b>fileTypes</b> argument can be used to filter which file types are available for selection in the file browser. The easiest way to get a list of valid file types is to use code completion in the Method Editor.

NAME	SYNTAX	DESCRIPTION
<code>importFile</code>	<code>importFile(ModelEntity entity, String name)</code>	Displays a file browser dialog box and uploads the selected file to the Filename text field in the given model object entity. This defines an input file that the application will need at a later stage. For example, the Filename of an interpolation function accessed with <code>model.func('&lt;tag&gt;')</code> . The uploaded file can be accessed with <code>upload:///&lt;tag&gt;/filename</code> .
<code>writeExcelFile</code>	<code>writeExcelFile(String name, String[][] data)</code>	Writes the given string array <b>data</b> starting from the first cell in the first sheet of an Excel file. This method requires LiveLink™ for Excel®.
<code>writeExcelFile</code>	<code>writeExcelFile(String name, String sheet, String cell, String[][] data)</code>	Writes the given string array <b>data</b> starting from the specified cell in the specified sheet of an Excel file. This method requires LiveLink™ for Excel®.
<code>readExcelFile</code>	<code>String[][] readExcelFile(String name)</code>	Reads the first sheet of an Excel file, starting from the first cell, into a <code>String[][]</code> . This method requires LiveLink™ for Excel®.
<code>readExcelFile</code>	<code>String[][] readExcelFile(String name, String sheet, String cell)</code>	Reads the specified sheet of an Excel file, starting from the specified cell, into a <code>String[][]</code> . This method requires LiveLink™ for Excel®.



NAME	SYNTAX	DESCRIPTION
<code>getFilePath</code>	<code>String getFilePath(String name)</code>	<p>Returns the absolute server file path of the server proxy file corresponding to a certain file scheme path, or null if the server proxy file for the given path does not exist.</p> <p>This method can be used to pass the path to, for example, a file using the <code>temp:///</code> scheme to external code or an application.</p> <p>In addition, this method is used to retrieve the file name of an uploaded file when using the file scheme <code>upload:///inputFile</code>, for example by using a File declaration together with a File Import form object.</p>
<code>getClientFileName</code>	<code>String getClientFileName(String name)</code>	<p>Returns the original name of an uploaded file on the client file system (or null if there is no uploaded file matching the given file scheme path).</p> <p>This method is only useful for providing user interface feedback. For example, to get information on which uploaded file is being used. There is no guarantee that the original file would still exist on the client or even that the current client would be the same as the original client.</p>

NAME	SYNTAX	DESCRIPTION
<code>getClientFilePath</code>	<code>String getClientFilePath(String name)</code>	Returns the original path of an uploaded file on the client file system (or null if there is no uploaded file matching the given file scheme path). Returns only the file name part of the path when called from an application running in a web browser.  This method is only useful for providing user interface feedback. For example, to get information on which uploaded file is being used. There is no guarantee that the original file would still exist on the client or even that the current client would be the same as the original client.
<code>createDirectory</code>	<code>createDirectory(String name)</code>	Creates a file directory <code>name</code> , see examples below in the Example Code section.

## EXAMPLE CODE

This line of code copies the uploaded file `file1` to the `temp` folder with new file name `file2.mphbin` and then prompts the user to save the file to any location.

```
copyFile("upload:///file1", "temp:///file2.mphbin");
fileSaveAs("temp:///file2.mphbin");
```

This line of code deletes the file `file2.mphbin` from the `temp` folder.

```
deleteFile("temp:///file2.mphbin");
```

This line of code creates a directory in the user folder, as specified in Preferences.

```
createDirectory("user:///a/b");
```

This line of code creates a directory in the Temp folder under C:.

```
createDirectory("C:\\Temp\\a\\b");
```

Note that the method `fileSaveAs` returns a boolean that indicates if saving the file was successful or not. Saving a file will fail if, for example, the user does not have access to the target folder.

## Operating System Methods

---

Operating system methods are used for accessing operating system information and commands from an application.

NAME	SYNTAX	DESCRIPTION
executeOSCommand	<code>String executeOSCommand(String command, String... params)</code>	Executes the OS command with the given command (full path) and parameters. Execution times out after a default 180 seconds. Returns everything the process printed to its out stream as a string. When applicable, the command is run server side.
executeOSCommand	<code>String executeOSCommand(String command, int timeoutSec, String params...)</code>	Executes the OS command with the given command (full path) and parameters. Returns everything the process printed to its out stream as a string. The execution is forcibly stopped after <b>timeoutSec</b> seconds if the command has not finished. To disable the timeout functionality, <b>timeoutSec</b> value 0 can be used. When applicable, the command is run server side.
fileOpen	<code>fileOpen(String name)</code>	Opens the file represented by name with the associated program on the client. Also see the section "Example code".
getUser	<code>String username = getUser()</code>	Returns the username of the user that is running the application. If the application is not run from COMSOL Server, then the value of the preference setting <b>General&gt;Username&gt;Name</b> is returned.
openURL	<code>openURL(String url)</code>	Opens a URL in the default browser on the client.

NAME	SYNTAX	DESCRIPTION
playSound	playSound(String name)	Plays the sounds in the given file on the client. Only .wav files are supported; no external libraries are required.
playSound	playSound(double hz, int millis)	Plays a signal at a given frequency hz and with given duration millis in milliseconds on the client.

### EXAMPLE CODE

The line of code below plays one of the sounds available in the `data/sounds` folder of the COMSOL installation and has been embedded in the application and stored in the Sounds library.

```
playSound("embedded:///success_1.wav");
```

In the command sequence of a form object, this is equivalent to selecting a sound node under **Libraries** and clicking **Run**.

The line of code below opens a PDF file embedded in the application and stored in the File library.

```
fileOpen("embedded:///li_ion_battery_impedance.pdf");
```

In the command sequence of a form object, this is equivalent to selecting an **Open File** node under **GUI Commands>File Commands** and clicking **Run**, as shown in the figure below.

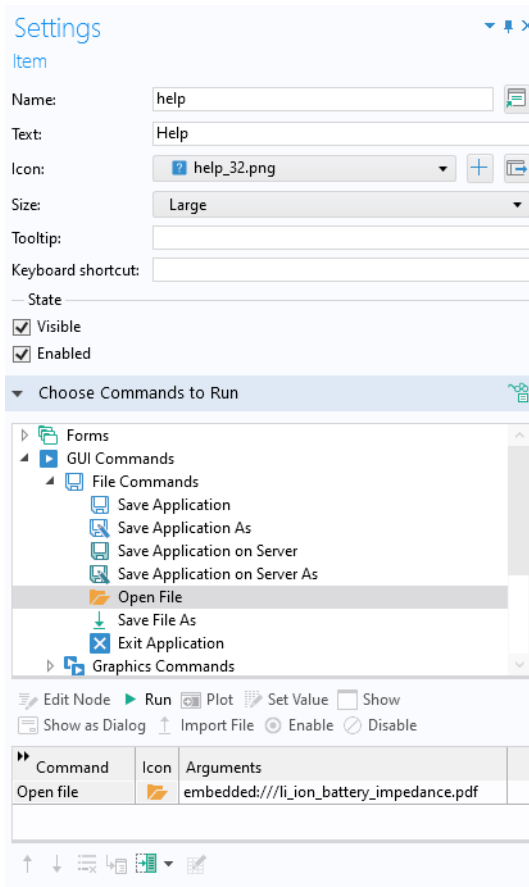

This line of code opens the COMSOL home page in the default browser:

```
openURL("https://www.comsol.com");
```

This line of code runs an application by means of an OS command:

```
executeOSCommand("C:\\COMSOL60\\Multiphysics\\bin\\win64\\comsol.exe",  
"-run", "C:\\work\\tubular_reactor.mph");
```

## Email Methods

---

Email methods are used for sending emails from an application, typically with attachments containing results from a simulation.

NAME	SYNTAX	DESCRIPTION
<code>emailFromAddress</code>	<code>String emailFromAddress()</code>	Returns the email from address from the COMSOL Server or preferences setting.
<code>sendEmail</code>	<code>sendEmail(String subject, String bodyText)</code>	Sends an email to the default recipient(s) with the specified subject and body text.
<code>sendEmail</code>	<code>sendEmail(String subject, String bodyText, ModelEntity... modelEntity)</code>	Sends an email to the default recipient(s) with the specified subject, body text, and zero or more attachments created from Report, Export, and Table nodes in the embedded model.
<code>sendEmail</code>	<code>sendEmail(String toAddress, String subject, String bodyText, ModelEntity... modelEntity)</code>	Sends an email to the specified recipient(s) with the specified subject, body text, and zero or more attachments created from Report, Export, and Table nodes in the embedded model.
<code>userEmailAddress</code>	<code>String userEmailAddress()</code>	Returns the user email address(es) corresponding to the currently logged in user, or an empty string if the user has not configured an email address.

### *Email Class Methods*

The class `EmailMessage` can be used to create custom email messages.

NAME	SYNTAX	DESCRIPTION
<code>EmailMessage</code>	<code>EmailMessage mail = new EmailMessage()</code>	Creates a new <code>EmailMessage</code> object.
<code>EmailMessage.setServer</code>	<code>mail.setServer(String host, int port)</code>	Sets the email (SMTP) server host and port to use for this email message.

NAME	SYNTAX	DESCRIPTION
EmailMessage.setUser	mail.setUser(String name, String password)	Sets the username and password to use for email (SMTP) server authentication. This method must be called after the <code>setServer</code> method.
EmailMessage.setSecurity	mail.setSecurity(String security)	Sets the connection security type for email (SMTP) server communication. Valid values are 'none', 'starttls' and 'tls'. This method must be called after the <code>setServer</code> method.
EmailMessage.setFrom	mail.setFrom(String fromAddress)	Sets the from address.
EmailMessage.setTo	mail.setTo(String... to)	Sets the to addresses.
EmailMessage.setCc	mail.setCc(String... cc)	Sets the cc addresses.
EmailMessage.setBcc	mail.setBcc(String... bcc)	Sets the bcc addresses.
EmailMessage.setSubject	mail.setSubject(String subject)	Sets the email subject line. Note that newline characters are not allowed.
EmailMessage.setBodyText	mail.setBodyText(String body)	Sets the email body as plain text. An email can contain both a text and an HTML body.
EmailMessage.setBodyHtml	mail.setBodyHtml(String body)	Sets the email body as HTML text. An email can contain both a text and an HTML body.
EmailMessage.attachFile	mail.attachFile(String filename)	Adds an attachment from a file. The attachment MIME type is determined by the file name extension.
EmailMessage.attachFile	mail.attachFile(String filename, String mimeType)	Adds an attachment from a file with the specified MIME type.
EmailMessage.attachFromModel	mail.attachFromModel(ModelEntity modelEntity)	Adds an attachment created from a report, export, or table feature in the model.
EmailMessage.attachText	mail.attachText(String text, String mimeType)	Adds a text attachment with a specified sub-MIME type, such as plain or HTML.

NAME	SYNTAX	DESCRIPTION
EmailMessage.attachBinary	mail.attachBinary(byte[] binary, String mimeType)	Adds an attachment from a byte array with the specified MIME type.
EmailMessage.send	mail.send()	Sends the email to the email (SMTP) server. An email object can only be sent once.

Each to, cc, and bcc address string can contain multiple email addresses separated by a comma or a semicolon character. Whitespace is allowed before and after the separator character.

## EMAIL PREFERENCES

To set preferences for an outgoing email (SMTP) server, open the **Email** page of the **Preferences** dialog box, as shown in the figure below.

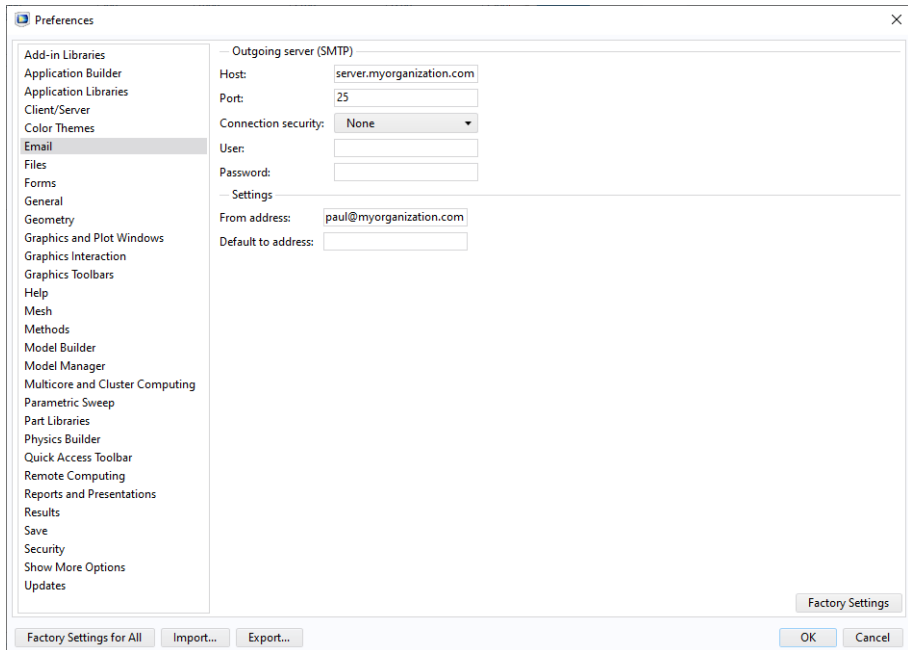

COMSOL Server provides a similar set of email preferences.

## EXAMPLE CODE

The following code sends an email and attaches a report:



```

EmailMessage mail = new EmailMessage();
mail.setTo(emailTo);
mail.setSubject("Tubular Reactor Simulation");
mail.setBodyText("The computation has finished. Please find the report
attached.");
mail.attachFromModel(model.result().report("rpt1"));
mail.send();

```

This code is run in the Tubular Reactor application, which is available as an application example in the Application Libraries. The figure below shows part of the user interface with an input field for the email address.

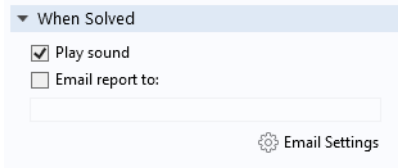

The figure below shows the corresponding form object and **Settings** window.

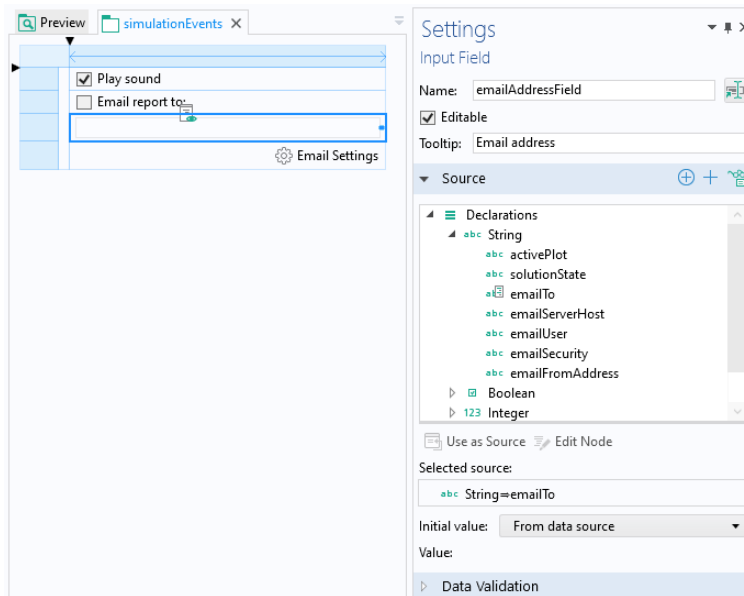

The following code is similar but also configures the email server settings.

```

EmailMessage mail = new EmailMessage();
mail.setServer("smtp.myemail.com", 587);
mail.setUser("user@myemail.com", "password");
mail.setSecurity("starttls");
mail.setFrom("user@myemail.com");

```

```

mail.setTo("otheruser@somedomain.com");
mail.setSubject("Tubular reaction simulation");
mail.setBodyText("The computation has finished");
mail.send();

```

## GUI-Related Methods

---

The graphical user interface (GUI) related methods are used for displaying dialog boxes with messages, editing form objects and user interface content, getting run-time properties of the application user interface, and running methods.

NAME	SYNTAX	DESCRIPTION
Call a method directly	<code>&lt;methodName&gt;()</code>	Call a method from the Methods list by using its name, for example, <code>method1()</code> , <code>method2()</code> .
<code>callMethod</code>	<code>callMethod(String name)</code>	Alternate way to call a method from the Methods list; used internally and in cases of name collisions.
<code>useGraphics</code>	<code>useGraphics(ModelEntity entity, String name)</code> <code>useGraphics(ModelEntity entity, FormObject graphics)</code>	Plots the given entity (Plot Group, Geometry, Mesh, Explicit Selection or Player Animation) in the graphics form object given by the name, name path, or graphics form object in the second argument.
<code>useForm</code>	<code>useForm(String name)</code>	Shows the form with the given name in the current main window. Equivalent to the <code>use</code> method of a <code>Form</code> object; see below.
<code>closeDialog</code>	<code>closeDialog(String name)</code>	Closes the form, shown as a dialog box, with the given name.
<code>dialog</code>	<code>dialog(String name)</code>	Shows the form with the given name as a dialog box. Equivalent to the <code>dialog</code> method of a <code>Form</code> object; see below.

NAME	SYNTAX	DESCRIPTION
alert	<code>alert(String text)</code>	Stops execution and displays an alert message with the given text.
alert	<code>alert(String text, String title)</code>	Stops execution and displays an alert message with the given text and title.
confirm	<code>String confirm(String text)</code>	Stops execution and displays a confirmation dialog box with the given text. It also displays two buttons, "Yes" and "No". The method returns "Yes" or "No" depending on what the user clicks.
confirm	<code>String confirm(String text, String title)</code>	Stops execution and displays a confirmation dialog box with the given text and title. It also displays two buttons, "Yes" and "No". The method returns "Yes" or "No" depending on what the user clicks.
confirm	<code>String confirm(String text, String title, String yes, String no)</code>	Stops execution and displays a confirmation dialog box with the given text and title. It also displays two buttons with the given strings as labels. The method returns the label of the button that the user clicks.
confirm	<code>String confirm(String text, String title, String yes, String no, String cancel)</code>	Stops execution and displays a confirmation dialog box with the given text and title. It also displays three buttons with the given strings as labels. The method returns the label of the button that the user clicks.
error	<code>error(String message)</code>	Stops execution and opens an error dialog box with the given message.

NAME	SYNTAX	DESCRIPTION
<code>error</code>	<code>error(String message, Throwable cause)</code>	Stops execution and opens an error dialog box with the given message including the underlying <b>cause</b> of class <b>Throwable</b> , the general Java exception class, or one of its subclasses, such as <b>RuntimeException</b> . This can be used to “wrap” native COMSOL Multiphysics error messages with custom error messages.
<code>request</code>	<code>String request(String text)</code>	Stops execution and displays a dialog box with a text field, requesting input from the user. The given text is the label of the text field. The method returns the entered text or <b>null</b> if the cancel button is clicked.
<code>request</code>	<code>String request(String text, String defaultString)</code>	Stops execution and displays a dialog box with a text field, requesting input from the user. The given text is the label of the text field and the default string is the text initially shown in the text field. The method returns the entered text or <b>null</b> if the cancel button is clicked.
<code>request</code>	<code>String request(String text, String title, String defaultString)</code>	Stops execution and displays a dialog box with a text field, requesting input from the user. The given text is the label of the text field, the default string is the text initially shown in the text field, and the title is the title of the dialog box. The method returns the entered text or <b>null</b> if the cancel button is clicked.

NAME	SYNTAX	DESCRIPTION
<code>message</code>	<code>message(String message)</code>	Sends a message to the message log if available in the application.
<code>message</code>	<code>message(arg)</code>	Sends a message <code>arg</code> to the message log. For an application this requires that a message log is added to the application user interface. The input argument <code>arg</code> can be a scalar, 1D array, or 2D array of the types string, double, int or Boolean.
<code>clearLog</code>	<code>clearLog()</code>	Clears the log window.
<code>clearMessageLog</code>	<code>clearMessageLog()</code>	Clears the message log window.
<code>evaluateToResultsTable</code>	<code>evaluateToResultsTable(NumericalFeature entity, String name, boolean clear)</code> <code>evaluateToResultsTable(NumericalFeature entity, FormObject graphics, boolean clear)</code>	Evaluates the given entity, a Derived Value, in the table object given by the name, name path, or graphics form object in the second argument, which will then be the default target for the evaluations of the Derived Value. If the third argument is true, the table is cleared before adding the new data, otherwise the data is appended.
<code>evaluateToDoubleArray2D</code>	<code>double[][]</code> <code>evaluateToDoubleArray2D(NumericalFeature entity)</code>	Evaluates the given entity, a Derived Value, and returns the non-parameter column part of the real table that is produced as a double matrix. All settings in the numerical feature are respected, but those in the current table connected to the numerical feature are ignored.

NAME	SYNTAX	DESCRIPTION
<code>evaluateToIntegerArray2D</code>	<code>int[][] evaluateToIntegerArray2D(NumericalFeature entity)</code>	Evaluates the given entity, a Derived Value, and returns the non-parameter column part of the real table that is produced as an integer matrix. All settings in the numerical feature are respected, but those in the current table connected to the numerical feature are ignored.
<code>evaluateToStringArray2D</code>	<code>String[][] evaluateToStringArray2D(NumericalFeature entity)</code>	Evaluates the given entity, a Derived Value, and returns the non-parameter column part of the, potentially complex, table that is produced as a string matrix. All settings in the numerical feature are respected but those in the current table connected to the numerical feature are ignored.
<code>useResultsTable</code>	<code>useResultsTable(TableFeature tableFeature, String resultsTable) useResultsTable(TableFeature tableFeature, FormObject resultsTable)</code>	Shows the values from the <code>tableFeature</code> in the <code>resultsTable</code> form object.
<code>getChoiceList</code>	<code>ChoiceList getChoiceList(String name)</code>	Returns an object of the type <code>ChoiceList</code> , representing a choice list node under the declarations branch. The type <code>ChoiceList</code> has methods that make it easier to change the matrix value with respect to changing and accessing values and display names individually.
<code>setFormObjectEnabled</code>	<code>setFormObjectEnabled(String name, boolean enabled)</code>	Sets the enable state for the form object specified by the name or name path.
<code>setFormObjectVisible</code>	<code>setFormObjectVisible(String name, boolean visible)</code>	Sets the visible state for the form object specified by the name or name path.

NAME	SYNTAX	DESCRIPTION
<code>setFormObjectText</code>	<code>setFormObjectText(String name, String text)</code>	Sets the text for the form object specified by the name or name path in the second argument. This method throws an error if it is impossible to set a text for the specified form object.
<code>setFormObjectEditable</code>	<code>setFormObjectEditable(String name, boolean editable)</code>	Sets the editable state for the form object specified by the name or name path. This functionality is only available for text field objects.
<code>setMenuBarItemEnabled</code>	<code>setMenuBarItemEnabled(String name, boolean enabled)</code>	Sets the enable state for the menu bar item specified by the <code>name</code> or name path (from menu bar) in the first argument.
<code>setMainToolbarItemEnabled</code>	<code>setMainToolbarItemEnabled(String name, boolean enabled)</code>	Sets the enable state for the main toolbar item specified by the name or name path (from main toolbar) in the first argument.
<code>setFileMenuItemEnabled</code>	<code>setFileMenuItemEnabled(String name, boolean enabled)</code>	Sets the enable state for the file menu item specified by the name or name path (from file menu) in the first argument.
<code>setRibbonItemEnabled</code>	<code>setRibbonItemEnabled(String name, boolean enabled)</code>	Sets the enable state for the ribbon item specified by the name or name path (from main window) in the first argument.
<code>setToolbarItemEnabled</code>	<code>setToolbarItemEnabled(String name, boolean enabled)</code>	Sets the enable state for the toolbar form object item specified by the name or name path in the first argument.
<code>useView</code>	<code>useView(View view, String name)</code> <code>useView(View view, FormObject graphics)</code>	Applies a view to the graphics contents given by the name, name path, or graphics form object in the second argument.

NAME	SYNTAX	DESCRIPTION
<code>resetView</code>	<code>resetView(String name)</code> <code>resetView(FormObject graphics)</code>	Resets the view to its initial state in the graphics contents given by the name, name path, or graphics form object in the second argument.
<code>getView</code>	<code>ViewBase getView(String name)</code> <code>ViewBase getView(FormObject graphics)</code>	Returns the view currently used by the graphics contents given by the name, name path, or graphics form object in the second argument.
<code>goToView</code>	<code>goToView(String name);</code>	Goes to a standard view in main graphics window. The parameter <b>name</b> is one of the view orientation strings in the following list: "xy", "xz", "yx", "yz", "zx", "zy".
<code>goToView</code>	<code>goToView(String name, String graphicsname);</code>	Goes to a standard view in the given graphics form object <b>graphicsname</b> .
<code>goToView</code>	<code>goToView(String name, FormObject graphics);</code>	Goes to standard view in the given graphics form object <b>graphics</b> .
<code>setWebPageSource</code>	<code>setWebPageSource(String name, String source)</code>	Sets the source for the form object specified by the name or name path in the first argument. This method throws an error if the name does not refer to a Web Page form object.
<code>getScreenHeight</code>	<code>int getScreenHeight()</code>	Returns the height in pixels of the primary screen on client system, or of the browser window if Web Client is used.



NAME	SYNTAX	DESCRIPTION
<code>getScreenWidth</code>	<code>int getScreenWidth()</code>	Returns the width in pixels of the primary screen on client system, or of the browser window if Web Client is used.
<code>storeChanges</code>	<code>storeChanges(String form)</code>	Commits the values entered in a dialog box having On request enabled. The method takes the name of the form as its argument.

## ALERTS AND MESSAGES

The methods `alert`, `confirm`, and `request` display a dialog box with a text string and optional user input. The following example uses `confirm` to ask the user if a direct or an iterative solver should be used in an application. Based on the answer, the `alert` function is then used to show the estimated memory requirement for the selected solver type in a message dialog box:

```
String answer = confirm("Which solver do you want to use?",
    "Solver Selection","Direct", "Iterative");
if (answer.equals("Direct")) {
    alert("Using the direct solver will require about 4GB of memory when solving.");
} else {
    alert("Using the iterative solver will require about 2GB of memory when solving.");
}
```

## EXAMPLE CODE

The following code changes the camera zoom angle and updates the graphics for each change.

```
useView(model.view("view1"), "/form1/graphics1");
for (int i = 0; i < 25; i++) {
    sleep(2000);
    model.view("view1").camera().set("zoomanglefull", 12-i*5.0/25);
    useGraphics(model.geom("geom1"), "/form1/graphics1");
}
```

This line of code displays plot group 5 (pg5) in the graphics object `graphics1` in the form with the name `Temperature`:

```
useGraphics(model.result("pg5"), "/Temperature/graphics1");
```

The code below displays the mesh in the model tree node `mesh1` in the graphics object `graphics1` contained in the card of a card stack. The second line runs a zoom extents command to ensure proper visualization of the mesh.

```
useGraphics(model.mesh("mesh1"), "/mesh/cardstack1/card1/graphics1");
```

```
zoomExtents("/mesh/cardstack1/card1/graphics1");
```

To clear the contents of a graphics object use a call such as

```
useGraphics(null, "/form1/graphics1");
```

The code below displays a request dialog box that lets the user type in a file name for an HTML report. If the user has typed a file name, then a report is generated.

```
String answerh = request("Enter file name", "File Name", "Untitled.html");
if (answerh != null) {
    model.result().report("rpt1").set("format", "html");
    model.result().report("rpt1").set("filename", "user:///"+answerh);
    model.result().report("rpt1").run();
}
```

The code below is similar to the code above, but in this case the report is saved in Microsoft® Word® format (.docx).

```
String answerw = request("Enter file name", "File Name", "Untitled.docx");
if (answerw != null) {
    model.result().report("rpt2").set("format", "docx");
    model.result().report("rpt2").set("filename", "user:///"+answerw);
    model.result().report("rpt2").run();
}
```

This line of code sets the view of the graphics object form1/graphics1 to **View 5**, as defined in the model tree:

```
useView(model.view("view5"), "form1/graphics1");
```

You can use **Data Access** in combination with **Editor Tools** to create a slider or an input field that sets the transparency level (alpha) of a plot group. The figure below shows a **Settings** window of a slider with the transparency level as **Source**.

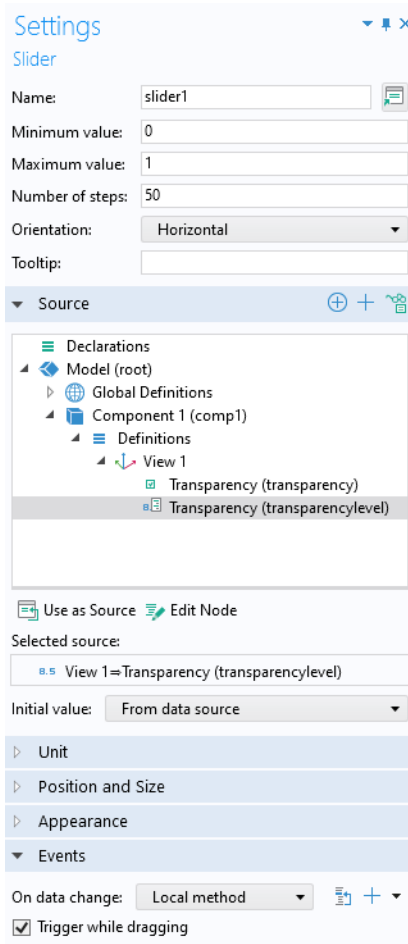

In this case you need to create a method for updating the view that is called to handle an event from the slider or form object. In the example above, the slider uses a **Local method** defined in the **Events** section. This method contains one line of code that updates the view:

```
useView(getView("/form1/graphics1"), "/form1/graphics1");
```

Note that different transparency levels are not supported when accessing an application from a browser using COMSOL Server.

Note that you can also set a view from the command sequence of, for example, a button: select a view subnode under the **Views** node in the editor tree and click the **Plot** button under the tree.

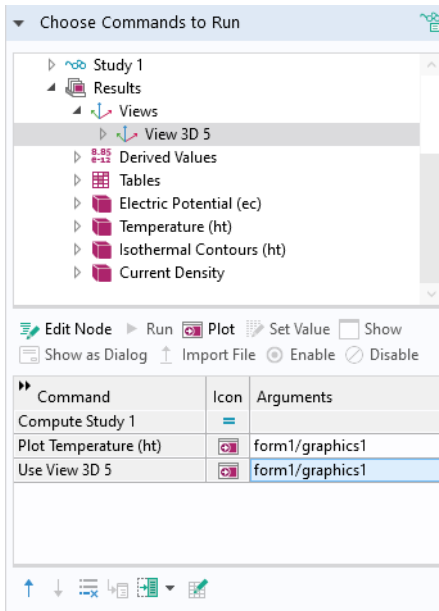

To go to one of the standard views in the main Graphics window, for example in an add-in, you can use:

```
goToView("xy");
```

In an application you can similarly use one of:

```
goToView("xz", "form1/graphics1");
goToView("yz", app.form("form1").formObject("graphics1"));
```

to go to the graphics object `graphics1` in the form `form1`.

This line of code sets the URL source of the form object `webpage1` to the COMSOL web page:

```
setWebPageSource("/form1/webpage1", "https://www.comsol.com");
```

This line of code forms a string containing the screen width and height:

```
screenSize = toString(getScreenWidth()) + "-by-" +
  toString(getScreenHeight());
```

You can present the string with an input field or a data display object using this string as a source (the string `screenSize` needs to be declared first).

## GUI Command Methods

---

The GUI command methods correspond to the **GUI Commands** node in the editor tree. The editor tree is displayed in, for example, the **Choose Commands to Run** section in the **Settings** window for a button object in the Application Builder.

NAME	SYNTAX	DESCRIPTION
<code>clearAllMeshes</code>	<code>clearAllMeshes()</code>	Clears all meshes.
<code>clearAllSolutions</code>	<code>clearAllSolutions()</code>	Clears all solutions.
<code>clearSelection</code>	<code>clearSelection(String graphics)</code> <code>clearSelection(FormObject graphics)</code>	Clears the selection in the given graphics object.
<code>exit</code>	<code>exit()</code>	Exits the application.
<code>fileOpen</code>	<code>fileOpen(String name)</code>	Opens a file with the associated program on the client.
<code>fileSaveAs</code>	<code>boolean fileSaveAs(String file)</code>	Downloads a file to the client. See also the section "Example code". The method returns a boolean that indicates if the operation was successful or not.
<code>printGraphics</code>	<code>printGraphics(String graphicsName)</code> <code>printGraphics(FormObject graphics)</code>	Prints the given graphics object.
<code>saveApplication</code>	<code>saveApplication()</code>	Saves the application.
<code>saveApplicationAs</code>	<code>saveApplicationAs()</code>	Saves the application under a different name. (Or as an MPH file.)
<code>sceneLight</code>	<code>sceneLight(String graphicsName)</code> <code>sceneLight(FormObject graphics)</code>	Toggles scene light in the given graphics object.
<code>selectAll</code>	<code>selectAll(String graphics)</code> <code>selectAll(FormObject graphics)</code>	Sets the selection to all entities in the given graphics object.
<code>transparency</code>	<code>transparency(String graphicsName)</code> <code>transparency(FormObject graphics)</code>	Toggles transparency in the given graphics object.
<code>zoomExtents</code>	<code>zoomExtents(String graphicsName)</code> <code>zoomExtents(FormObject graphics)</code>	Makes the entire model visible within the extent of the given graphics object.

### EXAMPLE CODE

For examples of how to use `fileSaveAs`, see the Introduction to Application Builder. This method is frequently needed for saving files in general.

You can create an application that saves and exits automatically by running the following lines of code, for example, after solving:

```
saveModel(model, "C:\\COMSOL\\file.mph");  
exit();
```

or

```
saveModel(model, "common:///file.mph");  
exit();
```

This is useful in a COMSOL Server setting since using `exit()` in this way will free up any licenses that are checked out.

## Debug Methods

---

The debug method is used to display variable contents in the **Debug Log** window.

NAME	SYNTAX	DESCRIPTION
<code>clearDebugLog</code>	<code>clearDebugLog()</code>	Clears the Debug Log window.
<code>debugLog</code>	<code>debugLog(arg)</code>	Prints the value of <code>arg</code> to the Debug Log window. The input argument <code>arg</code> can be a scalar, 1D array, or 2D array of the types string, double, int or Boolean.

### EXAMPLE CODE

The code below prints strings and doubles to the Debug Log window.

```
xcoords[i] = Math.cos(2.0*Math.PI*divid);  
ycoords[i] = Math.sin(2.0*Math.PI*divid);  
debugLog("These are component values for case 1:");  
debugLog("x:");  
debugLog(xcoords[i]);  
debugLog("y:");  
debugLog(ycoords[i]);
```

## Methods for External C Libraries

---

The methods for external C libraries are used for linking Application Builder methods with compiled C-code.

## EXTERNAL METHOD

NAME	SYNTAX	DESCRIPTION
<code>external</code>	<code>External external(String name)</code>	Returns an interface to an external C (native) library given by the name of the library feature. The External class uses the Java Native Interface (JNI) framework.

For more information, see the *Application Builder Reference Manual*.

## METHODS RETURNED BY THE EXTERNAL METHOD

The external method returns an object of type External with the following methods:

NAME	SYNTAX	DESCRIPTION
<code>invoke</code>	<code>long invoke(String method, Object... arguments)</code>	Invokes the named native method in the library with the supplied arguments. Strings are converted to <code>char *</code> . Returns the value returned by the method.
<code>invokeWideString</code>	<code>long invokeWideString(String method, Object... arguments)</code>	Invokes the named native method in the library with the supplied arguments. Strings are converted to <code>wchar_t *</code> . Returns the value returned by the method.
<code>close</code>	<code>void close()</code>	Releases the library and frees resources. If you do not call this method, it is automatically invoked when the external library is no longer needed.

## Progress Methods

---

Progress methods are used to create and update progress information in the Status bar, in a progress form object, and in a dialog box.

NAME	SYNTAX	DESCRIPTION
<code>setProgressInterval</code>	<code>setProgressInterval(String message, int intervalStart, int intervalEnd)</code>	<p>Sets a progress interval to use for the top-level progress and display <code>message</code> at that level. The top level will go from <code>intervalStart</code> to <code>intervalEnd</code> as the second level goes from 0 to 100. As the second level increases, the top level is increased by <math>(\text{intervalEnd} - \text{intervalStart}) * (\text{second level progress (0-100)} / 100)</math>.</p> <p>The value for <code>intervalStart</code> must be between 0 and <code>intervalEnd</code>, and the value for <code>intervalEnd</code> must be between <code>intervalStart</code> and 100.</p> <p>Calling this method implicitly resets any manual progress previously set by calls to <code>setProgress()</code>.</p>
<code>setProgress</code>	<code>setProgress(int value, String message)</code>	<p>Sets a value for the user-controlled progress level. By default, this is the top level, but if a progress interval is active (<code>setProgressInterval</code> has been called and <code>resetProgress</code> has not been called after that), then it is the second level.</p>
<code>setProgress</code>	<code>setProgress(int value)</code>	<p>Same as <code>setProgress(message, value)</code>, but uses the latest message or an empty string (if no message has been set).</p>



NAME	SYNTAX	DESCRIPTION
<code>resetProgress</code>	<code>resetProgress()</code>	Removes all progress levels and resets progress to 0 and the message to an empty string.
<code>showIndeterminateProgress</code>	<code>showIndeterminateProgress(String message)</code>	Shows a progress dialog box with an indeterminate progress bar, given <code>message</code> and a cancel button.
<code>showIndeterminateProgress</code>	<code>showIndeterminateProgress(String message, boolean cancelButton)</code>	Shows a progress dialog box with an indeterminate progress bar, given <code>message</code> and an optional cancel button.
<code>showProgress</code>	<code>showProgress()</code>	Shows a progress dialog box with a cancel button. No model progress is included.
<code>showProgress</code>	<code>showProgress(boolean modelProgress)</code>	Shows a progress dialog box with a cancel button and an optional model progress.
<code>showProgress</code>	<code>showProgress(boolean modelProgress, boolean addSecondLevel)</code>	Shows a progress dialog box with a cancel button, optional model progress, and one or two levels of progress information. Two levels can only be used if <code>modelProgress</code> is true.
<code>showProgress</code>	<code>showProgress(boolean modelProgress, boolean addSecondLevel, boolean cancelButton)</code>	Shows a progress dialog box with optional model progress, one or two levels, and possibly a cancel button. Two levels can only be used if <code>modelProgress</code> is true.
<code>closeProgress</code>	<code>closeProgress()</code>	Closes the currently shown progress dialog box.

NAME	SYNTAX	DESCRIPTION
<code>startProgress</code>	<pre>startProgress(String name) startProgress(FormObject progressBar)</pre>	<p>Resets the value of the given progress bar form object <code>name</code> to 0. The progress bar to control can be specified with an absolute path, such as <code>form1/progressbar1</code>, or a name relative to the context from which the method was called.</p> <p>Nothing is done if no progress bar corresponding to the given name is found.</p>
<code>setProgressBar</code>	<pre>setProgressBar(String name, int workDone, String message) setProgressBar(FormObject progressBar, int workDone, String message)</pre>	<p>Sets the value of the given progress bar form object <code>name</code> in the range 0-100 and the associated progress message. Values out of range are converted to 0 or 100. The progress bar to control can be specified with an absolute path, such as <code>form1/progressbar1</code>, or a name relative to the context from which the method was called.</p> <p>Nothing is done if no progress bar corresponding to the given name is found, or if the progress bar is used for showing model progress.</p>
<code>setProgressBar</code>	<pre>setProgressBar(String name, int workDone) setProgressBar(FormObject progressBar, int workDone)</pre>	<p>Same as above, but does not update the progress message.</p>

## EXAMPLE CODE

```
showProgress(true, true, true);
/* Opens a progress dialog box with cancel button showing two levels of
progress. The values shown in progress dialog box will be updated to match
the two levels of progress. */

setProgressInterval("Preparing application", 0, 20);
/* Sets the current progress scale to go from 0 to 20. This means that the
top-level progress will go from 0 to 20 when second-level progress goes from
0 to 100. */
```

```

setProgress(0, "Init step 1");
/* Sets the second-level progress to 0 and the second-level progress message
to "Init step 1". */

// do some work

setProgress(40);
/* Sets the second-level progress to 40, this causes the top-level progress
to be updated to 8 (40 % of 0-20). */

// do some work

setProgress(80, "Init step 2");
/* Sets the second-level progress to 80 and the progress message to "Init
step 2". The top-level message is still "Preparing application" and
top-level progress is now 16. */

// do some work

setProgressInterval("Meshing", 20, 40);
/* Sets the top-level interval to 20 - 40 and the progress message to
"Meshing" at this point the value shown at the top-level will be 20. The
second-level progress is cleared when the top-level interval is changed. */

<call-meshing algorithm here>
/* The progress messages and values from the meshing algorithm are shown at
the second-level progress. The top-level progress message will be "Meshing",
but the top-level progress advances from 20 to 40 while second-level
progress advances from 0 to 100. */

setProgressInterval("Solving", 40, 100);
/* The top-level progress message is changed to "Solving" and its value to
40.

<call-solver>
/* Similar to meshing, the progress messages and values from the solver are
shown in the second-level progress bar and the top-level progress value goes
from 40 to 100 while the solver progress goes from 0 to 100. */

closeProgress();

```

### *Application Progress Information*

Progress information can be displayed in three different ways: in the Status bar, in a progress form object, and in a dialog box. Application progress information is controlled by the `setProgress` methods, which take as their input an integer between 0 and 100 and an optional message. The integer represents how far the displayed progress bar has progressed. If no message is supplied, the last message provided is used. For example:

```

setProgress(10, "Computing data");
setProgress(25);

```

This will keep `Computing` data as the progress message.

Use the `setProgress` method by itself if you want to display custom progress in the task and status bar. Once you have done this, that progress bar will no longer be updated by progress information from the COMSOL model, but will be completely dependent on further calls to `setProgress` for changes in its value. Precede it with a call to `showProgress` to also display the built-in progress dialog box, see below.

Note that progress information from the COMSOL model will not be shown in between calls to `setProgress`. Progress is reset between method calls. If you want to combine custom steps of progress in methods with built-in model progress, then use `setProgressInterval` instead.

With `setProgressInterval`, you can control the top two levels of progress information. The second level can be displayed in a progress dialog box and a progress bar form object, see the code segment below. The second progress level, controlled by your own custom progress calculation, is connected to the first level such that one interval at the top level corresponds to the entire second level. Thus if the interval is 0–50, when the second level progress reaches 40, for example, the first level will be set to 20  $(=(40/100)*50)$ .

Important uses of the method `setProgressInterval` are listed below:

- Combining calls to the COMSOL model so that you get continuous progress going from 0–100.
- Computing several studies as well as evaluating several plots. Call `setProgressInterval` before each call to the built-in methods with an interval that approximates how much time each model computation takes. For example:

```
setProgressInterval("Computing solution", 0, 80);
model.study("std1").run();
setProgressInterval("Plotting", 80, 100);
useGraphics(model.result("pg3"), "energy_response_plot/graphics1");
```

- Combining one or more calls to built-in COMSOL methods with custom methods that in themselves take significant time. In this case, use `setProgressInterval` as in the previous example, followed by your own custom code with appropriate calls to `setProgress`. These calls should run from 0 to 100 as they are controlling the second progress level. For example:

```
setProgressInterval("Computing solution", 0, 60);
model.study("std1").run();
setProgressInterval("Working", 60, 80);
setProgress(0, "Specific message about what I'm doing");
// ...
// Code that does something
// ...
setProgress(60);
```

If you, in a running application, wish to no longer use progress intervals, call `resetProgress` to return to the original state. This will also reset progress to 0.

### *The Progress Dialog Box*

A progress dialog box can be used to display application progress as described in the previous section. The progress dialog has the following options:

- Whether to show model progress or not. When off, no progress from the model part of the application is forwarded to the progress dialog.
- Whether to show one or two progress levels in the progress dialog.
- Whether to include a cancel button. Cancel also works for user-defined methods, as it halts execution when the next line in the method is reached.

Use the `showProgress` methods to enable or disable these options. To close the progress dialog, use the `closeProgress` method.

You can show a progress dialog with an indeterminate progress bar that keeps spinning until you close the progress dialog. Only one progress dialog can be shown at a time. Use the `showIndeterminateProgress` methods to display this progress dialog.

### *The Progress Bar Form Object*

The **Progress Bar** form object can either show overall application progress information or customized partial progress information. If you have selected the **Include model progress** check box in the **Settings** window of the **Main Window** node, then the overall application progress information becomes available.

When **Include model progress** is selected, the progress bar will show the same information as the progress dialog box. That is, one or two levels of progress information and a cancel button, depending on the settings in the form object.

When **Include model progress** is cleared, you control the progress bar through the `setProgressBar` methods. These take the path name of the progress bar form object, for example, `main/progressbar1`.

## Date and Time Methods

---

The date and time methods are used to retrieve the current date and time as well as information on computation times.

NAME	SYNTAX	DESCRIPTION
<code>currentTime</code>	<code>String currentTime()</code>	Returns the current time as a string (not including date, and formatted according to the server defaults).
<code>currentTime</code>	<code>String currentTime()</code>	Returns the current date as a string (formatted according to the server's defaults) for the current date.
<code>formattedTime</code>	<code>String formattedTime(long timeInMs, String format)</code>	Returns a formatted time using the given format. The format can either be a time unit or a text describing a longer format. Supported formats are:  <code>'hr:min:sec'</code> which returns the time in hours, minutes and seconds in the form X hr Y min Z sec.  <code>'h:min:s'</code> which returns the time in hours, minutes and seconds in the form X h Y min Z s.  <code>'detailed'</code> which returns the time in seconds and also includes more readable units for longer times.
<code>sleep</code>	<code>sleep(long timeInMs)</code>	Sleep for the specified number of milliseconds.
<code>timeStamp</code>	<code>long timeStamp()</code>	Current time in milliseconds since midnight, January 1, 1970 UTC.

NAME	SYNTAX	DESCRIPTION
<code>getExpectedComputationTime</code>	<code>model.setExpectedComputationTime(String format)</code>	Returns a string describing the approximate computation time of the application. The string can be altered by the method <code>setExpectedComputationTime</code> .
<code>setLastComputationTime</code>	<code>model.setLastComputationTime(long time)</code>	Set the last computation time, overwriting the automatically generated time. You can use the <code>timeStamp</code> method to record time differences and set the measured time in ms (a long integer).
<code>getLastComputationTime</code>	<code>String model.getLastComputationTime(String format)</code>	Returns the last computation time in the given format. The format can either be a time unit or text describing a longer format. Currently supported formats are: <b>hr:min:sec</b> Returns the time in hours, minutes, and seconds in the format X h Y min Z sec. <b>h:min:s</b> Returns the time in hours, minutes, and seconds in the format X h Y min Z s. <b>detailed</b> Returns the time in seconds and also includes more readable units for longer times. This format is localized and the output is translated to the current language setting. For example, you can retrieve the time in ms by using <code>getLastComputationTime("ms")</code> .

## EXAMPLE CODE

The following code overrides the built-in computation time that is available in the information nodes in the model tree.

```
long t0 = timeStamp(); // initialize record of computation time

// code and computations

model.setLastComputationTime(timeStamp()-t0); // record computation time
```

If it is possible to give a rough estimate of the computation time based on the given inputs of an application, you can update the expected computation time and display it in an information card stack or a text object. Assume that there is an integer input called `objects` that controls the number of objects in a geometry array and that the computation roughly increases linearly with this number. The following code adjusts the expected computation time accordingly.

```
// Number of minutes of computation time per object
int minutes = objects*2.1;
model.setExpectedComputationTime("About " + minutes + " minutes" );
```

### *Sleep*

The code below makes the application idle for 1000 ms.

```
long delay = 1000;
sleep(delay);
```

This technique can be used to display graphics in a sequence.

For more information on information nodes and information cards, as well as the sleep method, see the book *Introduction to Application Builder*.



## Conversion Methods

---

Conversion methods are used to convert between the different data types Booleans, integers, doubles, strings, and arrays. These methods are shorthand versions of conversion methods in the standard Java libraries.

NAME	SYNTAX	DESCRIPTION
<code>toBoolean</code>	<code>boolean toBoolean(String str)</code>	Converts the given string to a Boolean. ('true' returns true, all other strings return false).
<code>toBoolean</code>	<code>boolean [] toBoolean(String[]... str)</code>	Converts all the strings in the given array to Booleans ('true' returns true, all other strings return false) and returns a Boolean array.
<code>toBoolean</code>	<code>boolean [][] toBoolean(String[][]... str)</code>	Converts all the strings in the given matrix to Booleans ('true' returns true, all other strings return false) and returns a Boolean matrix.
<code>toDouble</code>	<code>double toDouble(String str)</code>	Converts the given string to a double.
<code>toDouble</code>	<code>double[] toDouble(String... str)</code>	Converts all the strings in the given array to doubles and returns a double array.
<code>toDouble</code>	<code>double[][] toDouble(String[][]... str)</code>	Converts all the strings in the given matrix to doubles and returns a double matrix.
<code>toDouble</code>	<code>double toDouble(float flt)</code>	Converts the given float to a double.
<code>toDouble</code>	<code>double[] toDouble(float... flt)</code>	Converts all the floats in the given array to doubles and returns a double array.
<code>toDouble</code>	<code>double[][] toDouble(float[][]... flt)</code>	Converts all the floats in the given matrix to doubles and returns a double matrix.
<code>toInt</code>	<code>int toInt(String str)</code>	Converts the given string to an integer.
<code>toInt</code>	<code>int[] toInt(String... str)</code>	Converts all the strings in the given array to integers and returns an integer array.

NAME	SYNTAX	DESCRIPTION
<code>toInt</code>	<code>int[][] toInt(String[]... str)</code>	Converts all the strings in the given matrix to integers and returns an integer matrix.
<code>toString</code>	<code>String toString(int value)</code>	Converts the given integer to a string.
<code>toString</code>	<code>String toString(double value)</code>	Converts the given double to a string.
<code>toString</code>	<code>String toString(boolean value)</code>	Converts the given Boolean to a string.
<code>toString</code>	<code>String toString(double value, int decimals)</code>	Converts the given double to a string with the given number of decimals.
<code>toString</code>	<code>String toString(double value, int decimals, boolean remove)</code>	Converts the given double to a string with the given number of decimals with trailing zeros removed if the Boolean <code>remove</code> is <code>true</code> . For example, <code>10.0000001</code> with number of decimals set to <code>3</code> will return <code>10</code> rather than <code>10.000</code> .
<code>toString</code>	<code>String toString(double value, String format)</code>	Converts the given double to a string using the given format specifier, which is the same as <code>java.util.Formatter</code> . See the corresponding Java format string documentation for more information.
<code>toString</code>	<code>String[] toString(double[] darray)</code>	Converts all the doubles in the given array to strings and returns a string array.
<code>toString</code>	<code>String[][] toString(double[][] dmatrix)</code>	Converts all the doubles in the given matrix to strings and returns a string matrix.
<code>toString</code>	<code>String[] toString(int[] iarray)</code>	Converts all the integers in the given array to strings and returns a string array.
<code>toString</code>	<code>String[][] toString(int[][] imatrix)</code>	Converts all the integers in the given matrix to strings and returns a string matrix.

NAME	SYNTAX	DESCRIPTION
toString	String[] toString(boolean[] barray)	Converts all the Booleans in the given array to strings and returns a string array.
toString	String[][] toString(boolean[][] bmatrix)	Converts all the Booleans in the given matrix to strings and returns a string matrix.

## Array Methods

Array methods are used to add, remove, insert, and extract subsets of 1D and 2D arrays.

NAME	SYNTAX	DESCRIPTION
getColumn	String[] getColumn(String[][] matrix, int column)	Returns a String[] for a specified column in the matrix. Useful when values have been read from a file and only certain columns should be shown in a table.
getColumn	double[] getColumn(double[][] matrix, int column)	Returns a double[] for a specified column in the matrix.
getColumn	int[] getColumn(int[][] matrix, int column)	Returns an int[] for a specified column in the matrix.
getColumn	boolean[] getColumn(boolean[][] matrix, int column)	Returns a boolean[] for a specified column in the matrix.
getSubMatrix	String[][] getSubMatrix(String[][] matrix, int startCol, int endCol, int startRow, int endRow)	Returns a rectangular submatrix of the input matrix spanning columns from startCol to endCol, and rows from startRow to endRow.
getSubMatrix	double[][] getSubMatrix(double[][] matrix, int startCol, int endCol, int startRow, int endRow)	Returns a rectangular submatrix of the input matrix spanning columns from startCol to endCol, and rows from startRow to endRow.

NAME	SYNTAX	DESCRIPTION
getSubMatrix	<code>int[][] getSubMatrix(int[][] matrix, int startCol, int endCol, int startRow, int endRow)</code>	Returns a rectangular submatrix of the input matrix spanning columns from startCol to endCol, and rows from startRow to endRow.
getSubMatrix	<code>boolean[][] getSubMatrix(boolean[][] matrix, int startCol, int endCol, int startRow, int endRow)</code>	Returns a rectangular submatrix of the input matrix spanning columns from startCol to endCol, and rows from startRow to endRow.
insert	<code>String[] insert(String[] array, String value, int index)</code>	Inserts an element at position index in an array and returns the expanded array.
insert	<code>double[] insert(double[] array, double value, int index)</code>	Inserts an element at position index in an array and returns the expanded array.
insert	<code>int[] insert(int[] array, int value, int index)</code>	Inserts an element at position index in an array and returns the expanded array.
insert	<code>boolean[] insert(boolean[] array, boolean value, int index)</code>	Inserts an element at position index in an array and returns the expanded array.
insert	<code>String[] insert(String[] array, String[] value, int[] index)</code>	Inserts elements in an array at positions given by the index array and returns the expanded array.
insert	<code>double[] insert(double[] array, double[] value, int[] index)</code>	Inserts elements in an array at positions given by the index array and returns the expanded array.
insert	<code>int[] insert(int[] array, int[] value, int[] index)</code>	Inserts elements in an array at positions given by the index array and returns the expanded array.
insert	<code>boolean[] insert(boolean[] array, boolean[] value, int[] index)</code>	Inserts elements in an array at positions given by the index array and returns the expanded array.
append	<code>String[] append(String[] array, String value)</code>	Adds an element to the end of an array and returns the expanded array.
append	<code>double[] append(double[] array, double value)</code>	Adds an element to the end of an array and returns the expanded array.

NAME	SYNTAX	DESCRIPTION
append	<code>int[] append(int[] array, int value)</code>	Adds an element to the end of an array and returns the expanded array.
append	<code>boolean[] append(boolean[] array, boolean value)</code>	Adds an element to the end of an array and returns the expanded array.
append	<code>String[] append(String[] array, String[] value)</code>	Adds elements to the end of an array and returns the expanded array.
append	<code>double[] append(double[] array, double[] value)</code>	Adds elements to the end of an array and returns the expanded array.
append	<code>int[] append(int[] array, int[] value)</code>	Adds elements to the end of an array and returns the expanded array.
append	<code>boolean[] append(boolean[] array, boolean[] value)</code>	Adds elements to the end of an array and returns the expanded array.
remove	<code>String[] remove(String[] array, int index)</code>	Removes an element from an array and returns the shortened array.
remove	<code>double[] remove(double[] array, int index)</code>	Removes an element from an array and returns the shortened array.
remove	<code>int[] remove(int[] array, int index)</code>	Removes an element from an array and returns the shortened array.
remove	<code>boolean[] remove(boolean[] array, int index)</code>	Removes an element from an array and returns the shortened array.
remove	<code>String[] remove(String[] array, int[] index)</code>	Removes elements from an array and returns the shortened array.
remove	<code>double[] remove(double[] array, int[] index)</code>	Removes elements from an array and returns the shortened array.
remove	<code>int[] remove(int[] array, int[] index)</code>	Removes elements from an array and returns the shortened array.
remove	<code>boolean[] remove(boolean[] array, int[] index)</code>	Removes elements from an array and returns the shortened array.

NAME	SYNTAX	DESCRIPTION
insertRow	<code>String[][] insertRow(String[][] matrix, String[] value, int rowIndex)</code>	Inserts a row into a rectangular 2D array and returns the expanded array.
insertRow	<code>double[][] insertRow(double[][] matrix, double[] value, int rowIndex)</code>	Inserts a row into a rectangular 2D array and returns the expanded array.
insertRow	<code>int[][] insertRow(int[][] matrix, int[] value, int rowIndex)</code>	Inserts a row into a rectangular 2D array and returns the expanded array.
insertRow	<code>boolean[][] insertRow(boolean[][] matrix, boolean[] value, int rowIndex)</code>	Inserts a row into a rectangular 2D array and returns the expanded array.
insertRow	<code>String[][] insertRow(String[][] matrix, String[][] value, int[] rowIndex)</code>	Adds rows to a rectangular 2D array and returns the expanded array.
insertRow	<code>double[][] insertRow(double[][] matrix, double[][] value, int[] rowIndex)</code>	Adds rows to a rectangular 2D array and returns the expanded array.
insertRow	<code>int[][] insertRow(int[][] matrix, int[][] value, int[] rowIndex)</code>	Adds rows to a rectangular 2D array and returns the expanded array.
insertRow	<code>boolean[][] insertRow(boolean[][] matrix, boolean[][] value, int[] rowIndex)</code>	Adds rows to a rectangular 2D array and returns the expanded array.
replaceRow	<code>String[][] replaceRow(String[][] matrix, String[] value, int rowIndex)</code>	Replaces a row in a rectangular 2D array and returns the array.
replaceRow	<code>double[][] replaceRow(double[][] matrix, double[] value, int rowIndex)</code>	Replaces a row in a rectangular 2D array and returns the array.
replaceRow	<code>int[][] replaceRow(int[][] matrix, int[] value, int rowIndex)</code>	Replaces a row in a rectangular 2D array and returns the array.
replaceRow	<code>boolean[][] replaceRow(boolean[][] matrix, boolean[] value, int rowIndex)</code>	Replaces a row in a rectangular 2D array and returns the array.
replaceRow	<code>String[][] replaceRow(String[][] matrix, String[][] value, int[] rowIndex)</code>	Replaces rows in a rectangular 2D array and returns the array.
replaceRow	<code>double[][] replaceRow(double[][] matrix, double[][] value, int[] rowIndex)</code>	Replaces rows in a rectangular 2D array and returns the array.
replaceRow	<code>int[][] replaceRow(int[][] matrix, int[][] value, int[] rowIndex)</code>	Replaces rows in a rectangular 2D array and returns the array.

NAME	SYNTAX	DESCRIPTION
replaceRow	<code>boolean[][] replaceRow(boolean[][] matrix, boolean[][] value, int[] rowIndex)</code>	Replaces rows in a rectangular 2D array and returns the array.
appendRow	<code>String[][] appendRow(String[][] matrix, String[] value)</code>	Adds a row to the end of a rectangular 2D array and returns the expanded array.
appendRow	<code>double[][] appendRow(double[][] matrix, double[] value)</code>	Adds a row to the end of a rectangular 2D array and returns the expanded array.
appendRow	<code>int[][] appendRow(int[][] matrix, int[] value)</code>	Adds a row to the end of a rectangular 2D array and returns the expanded array.
appendRow	<code>boolean[][] appendRow(boolean[][] matrix, boolean[] value)</code>	Adds a row to the end of a rectangular 2D array and returns the expanded array.
appendRow	<code>String[][] appendRow(String[][] matrix, String[][] value)</code>	Adds rows to the end of a rectangular 2D array and returns the expanded array.
appendRow	<code>double[][] appendRow(double[][] matrix, double[][] value)</code>	Adds rows to the end of a rectangular 2D array and returns the expanded array.
appendRow	<code>int[][] appendRow(int[][] matrix, int[][] value)</code>	Adds rows to the end of a rectangular 2D array and returns the expanded array.
appendRow	<code>boolean[][] appendRow(boolean[][] matrix, boolean[][] value)</code>	Adds rows to the end of a rectangular 2D array and returns the expanded array.
removeRow	<code>String[][] removeRow(String[][] matrix, int rowIndex)</code>	Removes a row from a 2D array and returns the smaller array.
removeRow	<code>double[][] removeRow(double[][] matrix, int rowIndex)</code>	Removes a row from a 2D array and returns the smaller array.
removeRow	<code>int[][] removeRow(int[][] matrix, int rowIndex)</code>	Removes a row from a 2D array and returns the smaller array.
removeRow	<code>boolean[][] removeRow(boolean[][] matrix, int rowIndex)</code>	Removes a row from a 2D array and returns the smaller array.
removeRow	<code>String[][] removeRow(String[][] matrix, int[] rowIndex)</code>	Removes rows from a 2D array and returns the reduced array.
removeRow	<code>double[][] removeRow(double[][] matrix, int[] rowIndex)</code>	Removes rows from a 2D array and returns the reduced array.

NAME	SYNTAX	DESCRIPTION
removeRow	<code>int[][] removeRow(int[][] matrix, int[] rowIndex)</code>	Removes rows from a 2D array and returns the reduced array.
removeRow	<code>boolean[][] removeRow(boolean[][] matrix, int[] rowIndex)</code>	Removes rows from a 2D array and returns the reduced array.
insertColumn	<code>String[][] insertColumn(String[][] matrix, String[] value, int columnIndex)</code>	Adds a column into a rectangular 2D array and returns the expanded array.
insertColumn	<code>double[][] insertColumn(double[][] matrix, double[] value, int columnIndex)</code>	Adds a column into a rectangular 2D array and returns the expanded array.
insertColumn	<code>int[][] insertColumn(int[][] matrix, int[] value, int columnIndex)</code>	Adds a column into a rectangular 2D array and returns the expanded array.
insertColumn	<code>boolean[][] insertColumn(boolean[][] matrix, boolean[] value, int columnIndex)</code>	Adds a column into a rectangular 2D array and returns the expanded array.
insertColumn	<code>String[][] insertColumn(String[][] matrix, String[][] value, int[] columnIndex)</code>	Adds columns to a rectangular 2D array and returns the expanded array.
insertColumn	<code>double[][] insertColumn(double[][] matrix, double[][] value, int[] columnIndex)</code>	Adds columns to a rectangular 2D array and returns the expanded array.
insertColumn	<code>int[][] insertColumn(int[][] matrix, int[][] value, int[] columnIndex)</code>	Adds columns to a rectangular 2D array and returns the expanded array.
insertColumn	<code>boolean[][] insertColumn(boolean[][] matrix, boolean[][] value, int[] columnIndex)</code>	Adds columns to a rectangular 2D array and returns the expanded array.
replaceColumn	<code>String[][] replaceColumn(String[][] matrix, String[] value, int columnIndex)</code>	Replaces a column in a rectangular 2D array and returns the array.
replaceColumn	<code>double[][] replaceColumn(double[][] matrix, double[] value, int columnIndex)</code>	Replaces a column in a rectangular 2D array and returns the array.
replaceColumn	<code>int[][] replaceColumn(int[][] matrix, int[] value, int columnIndex)</code>	Replaces a column in a rectangular 2D array and returns the array.



NAME	SYNTAX	DESCRIPTION
replaceColumn	<code>boolean[][] replaceColumn(boolean[][] matrix, boolean[] value, int columnIndex)</code>	Replaces a column in a rectangular 2D array and returns the array.
replaceColumn	<code>String[][] replaceColumn(String[][] matrix, String[][] value, int[] columnIndex)</code>	Replaces columns in a rectangular 2D array and returns the array.
replaceColumn	<code>double[][] replaceColumn(double[][] matrix, double[][] value, int[] columnIndex)</code>	Replaces columns in a rectangular 2D array and returns the array.
replaceColumn	<code>int[][] replaceColumn(int[][] matrix, int[][] value, int[] columnIndex)</code>	Replaces columns in a rectangular 2D array and returns the array.
replaceColumn	<code>boolean[][] replaceColumn(boolean[][] matrix, boolean[][] value, int[] columnIndex)</code>	Replaces columns in a rectangular 2D array and returns the array.
appendColumn	<code>String[][] appendColumn(String[][] matrix, String[] value)</code>	Adds a column at the end of a rectangular 2D array and returns the expanded array.
appendColumn	<code>double[][] appendColumn(double[][] matrix, double[] value)</code>	Adds a column at the end of a rectangular 2D array and returns the expanded array.
appendColumn	<code>int[][] appendColumn(int[][] matrix, int[] value)</code>	Adds a column at the end of a rectangular 2D array and returns the expanded array.
appendColumn	<code>boolean[][] appendColumn(boolean[][] matrix, boolean[] value)</code>	Adds a column at the end of a rectangular 2D array and returns the expanded array.
appendColumn	<code>String[][] appendColumn(String[][] matrix, String[][] value)</code>	Adds columns to the end of a rectangular 2D array and returns the expanded array.
appendColumn	<code>double[][] appendColumn(double[][] matrix, double[][] value)</code>	Adds columns to the end of a rectangular 2D array and returns the expanded array.
appendColumn	<code>int[][] appendColumn(int[][] matrix, int[][] value)</code>	Adds columns to the end of a rectangular 2D array and returns the expanded array.
appendColumn	<code>boolean[][] appendColumn(boolean[][] matrix, boolean[][] value)</code>	Adds columns to the end of a rectangular 2D array and returns the expanded array.
removeColumn	<code>String[][] removeColumn(String[][] matrix, int columnIndex)</code>	Removes a column from a rectangular 2D array and returns the smaller array.

NAME	SYNTAX	DESCRIPTION
removeColumn	<code>double[][] removeColumn(double[][] matrix, int columnIndex)</code>	Removes a column from a rectangular 2D array and returns the smaller array.
removeColumn	<code>int[][] removeColumn(int[][] matrix, int columnIndex)</code>	Removes a column from a rectangular 2D array and returns the smaller array.
removeColumn	<code>boolean[][] removeColumn(boolean[][] matrix, int columnIndex)</code>	Removes a column from a rectangular 2D array and returns the smaller array.
removeColumn	<code>String[][] removeColumn(String[][] matrix, int[] columnIndex)</code>	Removes columns from a rectangular 2D array and returns the reduced array.
removeColumn	<code>double[][] removeColumn(double[][] matrix, int[] columnIndex)</code>	Removes columns from a rectangular 2D array and returns the reduced array.
removeColumn	<code>int[][] removeColumn(int[][] matrix, int[] columnIndex)</code>	Removes columns from a rectangular 2D array and returns the reduced array.
removeColumn	<code>boolean[][] removeColumn(boolean[][] matrix, int[] columnIndex)</code>	Removes columns from a rectangular 2D array and returns the reduced array.
matrixSize	<code>int[] matrixSize(String[][] matrix)</code>	Returns the number of rows and columns of a matrix as an integer array of length 2.
matrixSize	<code>int[] matrixSize(double[][] matrix)</code>	Returns the number of rows and columns of a matrix as an integer array of length 2.
matrixSize	<code>int[] matrixSize(int[][] matrix)</code>	Returns the number of rows and columns of a matrix as an integer array of length 2.
matrixSize	<code>int[] matrixSize(boolean[][] matrix)</code>	Returns the number of rows and columns of a matrix as an integer array of length 2.
transpose	<code>String[][] transpose(String[][] matrix)</code>	Returns the transpose of a matrix.
transpose	<code>double[][] transpose(double[][] matrix)</code>	Returns the transpose of a matrix.

NAME	SYNTAX	DESCRIPTION
transpose	<code>int[][] transpose(int[][] matrix)</code>	Returns the transpose of a matrix.
transpose	<code>boolean[][] transpose(boolean[][] matrix)</code>	Returns the transpose of a matrix.

## String Methods

String methods are used to process string variables and string arrays.

NAME	SYNTAX	DESCRIPTION
concat	<code>String concat(String separator, String ... str)</code>	Concatenates the given varargs-array of strings into a single string using the given separator.
concat	<code>String[] concat(String colSepar, String rowSepar, String[]... matr)</code>	Concatenates the given string matrix (which can be given as a varargs of rows) into a single string. Puts <code>colSepar</code> between values of columns of a row, and <code>rowSepar</code> between rows.
contains	<code>boolean contains(String[] str, String str)</code>	Returns true if the given string array <code>str</code> contains the given string <code>str</code> .
find	<code>int[] find(String[] str, String str)</code>	Returns an array with the indices to all occurrences of <code>str</code> in <code>str</code> .
findIn	<code>int findIn(String[] str, String str)</code>	Returns the index to the first occurrence of <code>str</code> in <code>str</code> or -1 if no match.
findIn	<code>int findIn(String str, String toFind)</code>	Returns the first index of <code>str</code> that is the start of the substring <code>toFind</code> . If there is no substring matching <code>toFind</code> in <code>str</code> , -1 is returned.
length	<code>int length(String str)</code>	Returns the length of the string <code>str</code> .
replace	<code>String replace(String str, String orig, String replacement)</code>	Returns a string where <code>orig</code> has been replaced by <code>replacement</code> .

NAME	SYNTAX	DESCRIPTION
split	<code>String[] split(String str)</code>	Returns an array of strings by splitting the given string at spaces.
split	<code>String[] split(String str, String separator)</code>	Returns an array of strings by splitting the given string at the given separator.
substring	<code>String substring(String str, int start, int length)</code>	Returns a substring with the given length starting at the given position.
unique	<code>String[] unique(String[] str)</code>	Returns an array of strings with the unique values in the given array of strings.

## Collection Methods

---

Collection methods are used to copy, compare, sort, and merge variables and arrays.

NAME	SYNTAX	DESCRIPTION
copy	<code>String[] copy(String... toCopy)</code>	Returns a copy of the given array of strings, which can also be specified as a varargs of strings.
copy	<code>String[][] copy(String[]... toCopy)</code>	Returns a copy of the given string matrix, which can also be specified as a varargs of rows (string arrays).
copy	<code>double[] copy(double... toCopy)</code>	Returns a copy of the given array of doubles, which can also be specified as a varargs of doubles.
copy	<code>double[][] copy(double[]... toCopy)</code>	Returns a copy of the given double matrix, which can also be specified as a varargs of rows (double arrays).
copy	<code>int[] copy(int... toCopy)</code>	Returns a copy of the given array of integers, which can also be specified as a varargs of integers.
copy	<code>int[][] copy(int[]... toCopy)</code>	Returns a copy of the given integer matrix, which can also be specified as a varargs of rows (integer arrays).

NAME	SYNTAX	DESCRIPTION
copy	<code>boolean[] copy(boolean... toCopy)</code>	Returns a copy of the given array of booleans, which can also be specified as a varargs of booleans.
copy	<code>boolean[][] copy(boolean[]... toCopy)</code>	Returns a copy of the given boolean matrix, which can also be specified as a varargs of rows (boolean arrays).
equals	<code>boolean equals(String[] str1, String[] str2)</code>	Returns true if all strings in the given array are equal and they have the same number of elements.
equals	<code>boolean equals(String[][] matr1, String[][] matr2)</code>	Returns true if all strings in the given matrix are equal and they have the same number of elements.
equals	<code>boolean equals(int[] ints1, int[] ints2)</code>	Returns true if all integers in the given array are equal and they have the same number of elements.
equals	<code>boolean equals(int[][] ints1, int[][] ints2)</code>	Returns true if all integers in the given matrix are equal and they have the same number of elements.
equals	<code>boolean equals(double d11, double d12, double relErrorTolerance)</code>	Compares whether the relative error of two doubles is within allowed tolerance using $\text{abs}((a - b) / b)$ , where $b$ is the larger of the doubles (by absolute value).
equals	<code>boolean equals(double d11, double d12)</code>	Same as above, but uses a default <code>relErrorTolerance</code> of 0.0001.
equals	<code>boolean equals(double[] dbls1, double[] dbls2, double relErrorTolerance)</code>	Compares the relative errors ( $\sim \text{abs}((a - b) / b)$ ) of elements in the arrays pairwise and returns true if all relative errors are below <code>relErrorTolerance</code> and the arrays have the same number of elements.
equals	<code>boolean equals(double[] dbls1, double[] dbls2)</code>	Same as above, but uses a default <code>relErrorTolerance</code> of 0.0001.

NAME	SYNTAX	DESCRIPTION
equals	<code>boolean equals(double[][] dbls1, double[][] dbls2, double relErrorTolerance)</code>	Compares the relative errors ( $\sim \text{abs}((a - b) / b)$ ) of elements in the matrices pairwise and returns true if all relative errors are below <code>relErrorTolerance</code> and the matrices have the same number of elements.
equals	<code>boolean equals(double[][] dbls1, double[][] dbls2)</code>	Same as above, but uses a default <code>relErrorTolerance</code> of <code>0.0001</code> .
sort	<code>sort(String[] strs)</code>	Sorts the given array of strings. NOTE: The array is sorted in place.
sort	<code>sort(int[] ints)</code>	Sorts the given array of integers. NOTE: The array is sorted in place.
sort	<code>sort(double[] doubles)</code>	Sorts the given array of doubles. NOTE: The array is sorted in place.
sort	<code>sort(String[][] strs)</code>	Sorts the given 2D array of strings. The columns are sorted by their row values from top to bottom. NOTE: The array is sorted in place.
sort	<code>sort(int[][] ints)</code>	Sorts the given 2D array of integers. The columns are sorted by their row values from top to bottom. NOTE: The array is sorted in place.
sort	<code>sort(double[][] doubles)</code>	Sorts the given 2D array of doubles. The columns are sorted by their row values from top to bottom. NOTE: The array is sorted in place.
merge	<code>merge(String[]... toMerge)</code>	Returns an array of strings with all strings merged from the given arrays.

NAME	SYNTAX	DESCRIPTION
merge	<code>merge(int[]... toMerge)</code>	Returns an array of integers with all integers merged from the two given arrays.
merge	<code>merge(double[]... toMerge)</code>	Returns an array of doubles with all doubles merged from the two given arrays.

## Model Builder Methods for Use in Add-Ins

For writing add-in method code that operates on the current component, current mesh, current physics etc. use the methods in the table below.

NAME	SYNTAX	DESCRIPTION
<code>getCurrentComponent</code>	<code>getCurrentComponent()</code>	Returns an object of the type <b>ModelNode</b> for the current component.
<code>getCurrentMesh</code>	<code>getCurrentMesh()</code>	Returns an object of the type <b>MeshSequence</b> for the current mesh.
<code>getCurrentNode</code>	<code>getCurrentNode()</code>	Returns an object of the type <b>ModelEntity</b> for the current component.
<code>getCurrentPhysics</code>	<code>getCurrentPhysics()</code>	Returns an object of the type <b>Physics</b> for the current physics interface.
<code>getCurrentPlotGroup</code>	<code>getCurrentPlotGroup()</code>	Returns an object of the type <b>ResultFeature</b> for the current component.
<code>getCurrentStudy</code>	<code>getCurrentStudy()</code>	Returns an object of the type <b>Study</b> for the current component.
<code>selectNode</code>	<code>selectNode(ModelEntity entity)</code>	Selects a model tree node and displays its Settings window after the execution of a method from the Model Builder.

These methods return the corresponding entity such that the method code in an add-in can operate on it. When called from an application a method in this

category returns null. Also, null is returned if no entity of the corresponding type exists such that nothing is current.

To learn more about using these methods you can review the Application Builder settings for one of the built-in add-ins by opening the corresponding MPH file. In a typical Windows® installation the built-in add-in library is located at

C:\Program Files\COMSOL\COMSOL60\Multiphysics\addins



## Programming Examples

---

This section contains examples that illustrate solving practical tasks by accessing and manipulating the model object and using the built-in methods. Note that additional examples of user-defined methods are provided in the example applications of the Application Libraries accessible from the **File** menu.

### Running the Examples

---

To run the code in the examples below, you can create a method for use in a model or application. You can, for example, choose the option **Blank Model** in the Model Wizard. To create a new method, go to the **Developer** tab in the Model Builder and click the **New Method** button in the ribbon. In the Application Builder, paste the code into the new method. Finally, you can run the code from the **Developer** tab in the Model Builder by choosing the method you just created from the **Run Method** toolbar menu.

### Visualization Without Solution Data: Grid Datasets

---

The section “Results” on page 48 shows how to write code for various parts of the Results node in the model tree, including **Datasets**, **Tables**, and **Plot Groups**. These examples assume that you have solution data available from solving, for example, a heat transfer, CFD, or structural mechanics problem.

You can also create visualizations without having associated solution data by either using grid datasets or using low-level functionality only available through methods. You can, for example, write code for plotting points and triangles without any associated solution data. These techniques are useful when creating applications where customized plot functionality is needed. This section shows how to use grid datasets, and the next section shows how to use low-level functionality.

#### PLOTTING A UNIT SPHERE USING A GRID DATASET

Grid datasets are available in the Model Builder and can be used in applications for the sole purpose of visualization without any associated solution data. The code below creates a visualization of a unit sphere as an isosurface with the  $z$ -coordinate as color data.

```

model.func().create("an1", "Analytic");
model.result().dataset().create("grid1", "Grid3D");

with(model.result().dataset("grid1"));
    set("source", "data");
    set("parmin1", -1);
    set("parmax1", +1);
    set("parmin2", -1);
    set("parmax2", +1);
    set("parmin3", -1);
    set("parmax3", +1);
    set("source", "function");
    set("function", "an1");
endwith();

model.result().create("pg1", "PlotGroup3D");
model.result("pg1").create("iso1", "Isosurface");

with(model.result("pg1").feature("iso1"));
    set("expr", "x^2+y^2+z^2-1");
    set("levelmethod", "levels");
    set("levels", 0.0);
endwith();

model.result("pg1").feature("iso1").create("col1", "Color");
with(model.result("pg1").feature("iso1").feature("col1"));
    set("expr", "z");
endwith();

model.result("pg1").run();

```

### Comments

If there is no solution-based **Dataset** available, then the **Grid3D** dataset needs to have a **Function** as its **Source**. In the example above, a default **Analytic** function is created with tag **an1**. A default **Analytic** function corresponds to  $f(x) = x$ , and its only purpose is to give the grid dataset an evaluation context.

**Note:** The alternative is to solve a physics problem on a mesh and reference the corresponding solution dataset. The method of referencing a **Function** makes it possible to create visualizations without solution data.

The source for the **Grid3D** dataset with tag **grid1** is set to **function**, and finally, the function property of **grid1** is set to **an1**.

The **Grid3D** dataset has options for max and min parameter bounds, shown in the example code above. An additional grid resolution option is not shown in this example. However, you can learn about its syntax by using **Record Code** from the Model Builder.

## Visualization of Points, Curves, and Surfaces

---

The following examples describe low-level functionality for visualization that is only available from methods and is not associated with any solution data. For visualization based on solution data, see the section “Results” on page 48.

The examples below illustrate using the following plot types:

- **Point Data**
- **Line Data**
- **Surface Data**
- **Tube Data**
- **Arrow Data**
- **Annotation Data**

Once created, the plot type names are visible in the **Settings** window of each plot. In addition to the properties modified by the examples below, in the **Settings** window of these plot types, you can see the number of geometric entities created, such as number of points, line segments, and triangles. Just as for other types of plots, you can also change the **Range** of color and data, as well as **Coloring and Style**.

### POINTS IN 2D

The following code plots a circle of points using the **Point Data** plot type.

```
// A circle of points

String pgTag = model.result().uniquetag("pg");
ResultFeature pg = model.result().create(pgTag, 2);
ResultFeature plot = pg.create("pt1", "PointData");
int N = 17;
double[][] p = new double[2][N];
double[] color = new double[N];
double R = 1000;
for (int i = 0; i < N; i++) {
    double angle = i*2*Math.PI/N;
    p[0][i] = R*Math.cos(angle);
    p[1][i] = R*Math.sin(angle);
    color[i] = p[1][i];
}
plot.set("pointdata", p)
    .set("colordata", color)
    .set("coloring", "colortable");
plot.run();
```

#### *Comments*

The first line

```
String pgTag = model.result().uniquetag("pg");
```

creates a unique tag for the plot group to be created. This is useful if you intend to add a varying number of plot groups in your model or application.

The line

```
ResultFeature pg = model.result().create(pgTag, 2);
```

creates a **2D Plot Group** using the newly created unique tag. The second argument to `create` defines the dimension of the plot group (2 for 2D, 3 for 3D, etc.).

The line

```
ResultFeature plot = pg.create("pt1", "PointData");
```

creates a plot of the type `PointData`. This plot type is only available through methods.

The middle part of the example code generates the points making up the circle. The point coordinates are stored in the 2-by-N array `p`, along with color data in the array `color` of length N. The color data is, in this example, simply based on the index of the points and is used to control the coloring of each point based on a color table.

The last few lines populate the fields of the **Point Data** plot.

```
plot.set("pointdata", p)
     .set("colordata", color)
     .set("coloring", "colortable");
```

The property `pointdata` takes the 2-by-N array `p` as its input. The options for the `coloring` property are `colortable` or `uniform`.

To learn about the syntax for the additional properties available for a **Point Data** plot, you can run the above code in a blank model, browse to the **Settings** window for the **Point Data** plot, click **Record Code**, and change the corresponding plot properties. Note that the name of the plot type in the **Settings** window of the plot in the model tree is **Point Data**.

## TURNING OFF MODEL HISTORY

When using this type of low-level functionality for larger sets of data, such as a large number of points, the stored model history may become excessively large. Because of this, it is recommended to temporarily turn off model history recording when using this type of functionality; see “Turning Off and Resetting The Model History” on page 52.

## POINTS IN 3D

The following code plots points in an undulating pattern in 3D using the **Point Data** plot type.

```
// Undulating points in 3D
```

```

String pgTag = model.result().uniquetag("pg");
ResultFeature pg = model.result().create(pgTag, 3);
ResultFeature plot = pg.create("pt1", "PointData");
int N = 37;
double[][] p = new double[3][N];
double[] color = new double[N];
double R = 1000;
for (int i = 0; i < N; i++) {
    double angle = i*2*Math.PI/N;
    p[0][i] = R*Math.cos(angle);
    p[1][i] = R*Math.sin(angle);
    p[2][i] = R*Math.cos(3*angle);
    color[i] = p[1][i];
}
plot.set("pointdata", p)
    .set("colordata", color)
    .set("coloring", "colortable")
    .set("sphereradiusscale", 1);
plot.run();
selectNode(pg);

```

### Comments

When plotting 3D points the line

```
model.result().create(pgTag, 3);
```

has the second argument set to 3 in order to create a **3D Plot Group**. In 3D, the point coordinates, `p` is a 3-by-N array.

The line

```
.set("sphereradiusscale", 1);
```

controls the radius of the sphere used to render each point.

To automatically display the newly created plot, the line

```
selectNode(pg);
```

is added last in the code segment.

To get a denser set of points, you can increase the integer `N` to, say, 370.

### CURVE IN 3D

The following code plots line segments in the shape of a 3D helix using the **Line Data** plot type.

```

// A 3D helix from line segments

String pgTag = model.result().uniquetag("pg");
ResultFeature pg = model.result().create(pgTag, 3);
ResultFeature plot = pg.create("line1", "LineData");
int N = 100;
double[][] p = new double[3][N];
int[][] t = new int[2][N-1];
for (int i = 0; i < N; i++) {
    double s = 4*Math.PI*i/N;

```

```

    p[0][i] = s/5;
    p[1][i] = Math.sin(s);
    p[2][i] = Math.cos(s);
    if (i > 0) {
        t[0][i-1] = i-1;
        t[1][i-1] = i;
    }
}
plot.set("pointdata", p)
    .set("elementdata", t);
plot.run();
selectNode(pg);

```

## Comments

### The line

```
ResultFeature plot = pg.create("line1", "LineData");
```

creates a plot of the type `LineData`. This plot type is only available through methods. Just as for **Point Data** plots, the point coordinates `p` is a 3-by-`N` array. In addition to `pointdata`, the `LineData` plot type takes `elementdata` as its input. In the example, this is represented by the 2-by-`N` array `t` and contains indexes to the columns of `p`, corresponding to the start and end points of the lines.

In a similar way, line segments can be plotted in 2D by creating a 2D plot group and by letting the point coordinates be a 2-by-`N` array. See also “Points in 2D” on page 155.

## TRIANGULATED SHAPE IN 2D

The following code plots triangles in the shape of a 2D pentagon by using the **Surface Data** plot type.

```

// A 2D pentagon from triangles

String pgTag = model.result().uniquetag("pg");
ResultFeature pg = model.result().create(pgTag, 2);
ResultFeature plot = pg.create("surf1", "SurfaceData");
int N = 5;
double[][] p = new double[2][N+1];
int[][] t = new int[3][N];
p[0][0] = 0;
p[1][0] = 0;
for (int i = 0; i < N; i++) {
    double angle = i*2*Math.PI/N;
    p[0][i+1] = Math.cos(angle);
    p[1][i+1] = Math.sin(angle);
    t[0][i] = 0;
    t[1][i] = i+1;
    t[2][i] = 1+(i+1)%N;
}
plot.set("pointdata", p)
    .set("elementdata", t);
plot.run();

```

```
selectNode(pg);
```

## Comments

The line

```
ResultFeature plot = pg.create("surf1", "SurfaceData");
```

creates a plot of the type `SurfaceData`. This plot type is only available through methods. Just as for 2D **Point Data** plots, the point coordinates `p` is a 2-by-`N` array. In addition to `pointdata`, and similar to the `LineData` plot type, the `SurfData` plot type takes `elementdata` as its input. In the example, this is represented by the 3-by-`N` array `t` and contains indexes to the columns of `p`, corresponding to the vertexes of the triangles. The ordering of the point indexes in the array `t` is not important for 2D Surface Data plots.

## FUNCTION SURFACE IN 3D

The following code plots triangles in the shape of a 3D rotationally symmetric sinc-function surface by using the **Surface Data** plot type.

```
// A 3D sinc(r) function surface

String pgTag = model.result().uniquetag("pg");
ResultFeature pg = model.result().create(pgTag, 3);
ResultFeature plot = pg.create("surf1", "SurfaceData");
int Nx = 51;
int Ny = 51;
double[][] p = new double[3][Nx*Ny];
int[][] t = new int[3][2*(Nx-1)*(Ny-1)];
double[] color = new double[Nx*Ny];
int pos = 0;
for (int i = 0; i < Ny; i++) {
    for (int j = 0; j < Nx; j++) {
        double x = 20*(j-Nx/2)/Nx;
        double y = 20*(i-Ny/2)/Ny;
        double r = Math.sqrt(x*x+y*y);
        double z = 4*((r == 0) ? 1 : (Math.sin(r)/r));
        p[0][pos] = x;
        p[1][pos] = y;
        p[2][pos] = z;
        color[pos] = z;
        pos++;
    }
}
pos = 0;
for (int i = 0; i < Ny-1; i++) {
    for (int j = 0; j < Nx-1; j++) {
        int p00 = Nx*i+j;
        int p01 = Nx*i+j+1;
        int p10 = Nx*(i+1)+j;
        int p11 = Nx*(i+1)+j+1;
        t[0][pos] = p00;
        t[1][pos] = p01;
        t[2][pos] = p11;
```

```

        pos++;
        t[0][pos] = p00;
        t[1][pos] = p11;
        t[2][pos] = p10;
        pos++;
    }
}
plot.set("pointdata", p)
    .set("elementdata", t)
    .set("colordata", color)
    .set("coloring", "colortable");
plot.run();
selectNode(pg);

```

### Comments

This example is similar to “Triangulated Shape in 2D” on page 158, but with the point array being a 3-by-N array for 3D surfaces. For **Surface Data** plots in 3D, the ordering of the indexes in the `elementdata` array `t` matters. It determines the direction of the surface normal, which is used for the lighting effect when using **Scene Light** in the **Graphics** window. The surface normal of a triangle is determined according to the “right-hand rule”. In mathematical terms, the surface normal is defined as the vector product:

$$\mathbf{n} = (\mathbf{p}[t[1]] - \mathbf{p}[t[0]]) \times (\mathbf{p}[t[2]] - \mathbf{p}[t[0]])$$

where the indexes into `t` represent the rows in one of the columns of `t` and `p` represents a column in the array of points `p`.

To ensure that the lighting effect produces expected results, the triangle surface normal directions need to consistently point in the same direction as the intended overall surface normal direction. As an alternative to making sure that the indexes come in the correct order, the normal direction may be given as an additional input to a **Surface Data** plot. This is shown in the next example section, [Sphere in 3D](#).

### SPHERE IN 3D

The following code plots triangles in the shape of a 3D sphere by using the **Surface Data** plot type.

```

// A coarse sphere with user-supplied normals

int Nx = 20;
int Ny = 10;
String pgTag = model.result().uniquetag("pg");
ResultFeature pg = model.result().create(pgTag, 3);
ResultFeature plot = pg.create("surf1", "SurfaceData");
double[][] p = new double[3][Nx*Ny];
double[][] normals = new double[3][Nx*Ny];
int[][] t = new int[3][2*(Nx-1)*(Ny-1)];
double[] color = new double[Nx*Ny];

```



```

int pos = 0;
double R = 10;
for (int i = 0; i < Ny; i++) {
    for (int j = 0; j < Nx; j++) {
        double theta = Math.PI*i/(Ny-1);
        double phi = 2*Math.PI*j/(Nx-1);
        double x = R*Math.sin(theta)*Math.cos(phi);
        double y = R*Math.sin(theta)*Math.sin(phi);
        double z = R*Math.cos(theta);
        p[0][pos] = x;
        p[1][pos] = y;
        p[2][pos] = z;
        normals[0][pos] = x;
        normals[1][pos] = y;
        normals[2][pos] = z;
        color[pos] = z;
        pos++;
    }
}
pos = 0;
for (int i = 0; i < Ny-1; i++) {
    for (int j = 0; j < Nx-1; j++) {
        int p00 = Nx*i+j;
        int p01 = Nx*i+j+1;
        int p10 = Nx*(i+1)+j;
        int p11 = Nx*(i+1)+j+1;
        t[0][pos] = p00;
        t[1][pos] = p01;
        t[2][pos] = p11;
        pos++;
        t[0][pos] = p00;
        t[1][pos] = p11;
        t[2][pos] = p10;
        pos++;
    }
}
plot.set("pointdata", p)
    .set("elementdata", t)
    .set("colordata", color)
    .set("normaldata", normals)
    .set("coloring", "colortable");
plot.run();
selectNode(pg);

```

### *Comments*

In this example, information about the surface normal direction is not given implicitly by the triangle orientation, but instead explicitly by the parameter `normaldata` by means of the 3-by- $N_x \times N_y$  array `normals` containing surface normal vectors at each point. The normal vectors do not need to be normalized; only the direction is used. The coloring of the sphere is based on the  $z$ -coordinate of each triangle point and is stored for each point in the 3-by- $N_x \times N_y$  array `color`.

The sphere is constructed from a discrete grid defined in terms of spherical coordinate angles, where each grid cell is divided into two triangles. The number of triangles  $t$  is then given by  $2*(N_x - 1)*(N_y - 1)$ .

## TUBE PLOT IN 3D, LOGARITHMIC SPIRAL

The following code plots a tube in 3D in the shape of a logarithmic spiral by using the **Tube Data** plot type.

```
// A logarithmic tube spiral in 3D

String pgTag = model.result().uniquetag("pg");
ResultFeature pg = model.result().create(pgTag, 3);
ResultFeature plot = pg.create("tube1", "TubeData");
int N = 1000;
double[][] p = new double[3][N];
double[] radius = new double[N];
double[] color = new double[N];
for (int i = 0; i < N; i++) {
    double par = 0.005*i;
    p[0][i] = Math.exp(par)*Math.cos(10*par);
    p[1][i] = Math.exp(par)*Math.sin(10*par);
    p[2][i] = 0.1*i;
    radius[i] = 0.2*Math.sqrt(i+1);
    color[i] = i;
}
plot.set("pointdata", p)
    .set("radiusdata", radius)
    .set("colordata", color)
    .set("coloring", "colortable");
plot.run();
selectNode(pg);
```

### Comments

A **Tube Data** plot is similar to a **Point Data**, plot but with an absolute radius array given as an argument to `radiusdata`. For the **Point Data** plot type, there is a similar `sphereradiusscale`.

## ARROWS IN 2D

The following code plots arrows in a circular pattern by using the **Arrow Data** plot type.

```
// Arrows in a circular pattern in 2D

String pgTag = model.result().uniquetag("pg");
ResultFeature pg = model.result().create(pgTag, 2);
ResultFeature plot = pg.create("arrow1", "ArrowData");
int N = 17;
double[][] p = new double[2][N];
double[][] vec = new double[2][N];
double len = 0.2;
for (int i = 0; i < N; i++) {
```

```

    double angle = 2*Math.PI*i/N;
    p[0][i] = Math.cos(angle);
    p[1][i] = Math.sin(angle);
    vec[0][i] = -len*p[0][i];
    vec[1][i] = -len*p[1][i];
}
plot.set("pointdata", p)
    .set("vectordata", vec);
plot.run();
selectNode(pg);

```

### Comments

An **Arrow Data** plot associates an array of vectors, in the example `vec`, to each point `p`.

## ARROWS IN 3D

The following code plots arrows in a logarithmic spiral pattern by using the **Arrow Data** plot type.

```

// Arrows in a logarithmic spiral pattern in 3D

String pgTag = model.result().uniqueTag("pg");
ResultFeature pg = model.result().create(pgTag, 3);
ResultFeature plot = pg.create("arrow1", "ArrowData");
int N = 1000;
double[][] p = new double[3][N];
double[][] vec = new double[3][N];
double[] color = new double[N];
for (int i = 0; i < N; i++) {
    double par = 0.005*i;
    p[0][i] = Math.exp(par)*Math.cos(10*par);
    p[1][i] = Math.exp(par)*Math.sin(10*par);
    p[2][i] = 0.1*i;
    double len = Math.sqrt(p[0][i]*p[0][i]+p[1][i]*p[1][i]+p[2][i]*p[2][i]);
    for (int j = 0; j < 3; j++) {
        vec[j][i] = 4*p[j][i]/len;
    }
    color[i] = i;
}
plot.set("pointdata", p)
    .set("vectordata", vec)
    .set("colordata", color)
    .set("coloring", "colortable");
plot.run();
selectNode(pg);

```

### Comments

In this example, in addition to the example in the section “Arrows in 2D”, color data is used based on the point index.

## ANNOTATIONS IN 2D

The following code renders text strings in a circular pattern by using the **Annotation Data** plot type.

```
// Letters in a circular pattern in 2D

String pgTag = model.result().uniquetag("pg");
ResultFeature pg = model.result().create(pgTag, 2);

for (int i = 0; i < 26; i++) {
    double angle = 2*Math.PI*i/26;
    ResultFeature plot = pg.create("ann"+i, "AnnotationData");
    plot.set("pos", new double[]{Math.cos(angle), Math.sin(angle)});
    .set("text", "ABCDEFGHIJKLMNOPQRSTUVWXYZ".substring(i, i+1))
    .set("showpoint", false);
}
pg.run();
selectNode(pg);
```

### Comments

The property `pos` takes as its input an array of length 2 representing 2D coordinates for the position of the string to be rendered. The property `text` takes as its input the string to be rendered. The Boolean property `showpoint` determines if a point, at the 2D coordinate position, should be rendered or not.

## ANNOTATIONS IN 3D WITH LATEX SYNTAX

The following code renders text strings with Greek letters of different colors at the corners of a cube by using the **Annotation Data** plot type.

```
// Greek letters at the corners of a cube

String pgTag = model.result().uniquetag("pg");
ResultFeature pg = model.result().create(pgTag, 3);

String[] texts = {"\\alpha", "\\beta", "\\gamma", "\\delta", "\\epsilon",
"\\zeta", "\\eta", "\\theta"};
String[] colors = {"black", "blue", "cyan", "gray", "green", "magenta", "red",
"yellow"};
for (int x = 0; x < 2; x++) {
    for (int y = 0; y < 2; y++) {
        for (int z = 0; z < 2; z++) {
            int index = x+2*y+4*z;
            ResultFeature plot = pg.create("ann"+index, "AnnotationData");
            plot.set("pos", new double[]{x, y, z})
                .set("text", "$"+texts[index]+"$")
                .set("latexmarkup", true)
                .set("color", colors[index]);
        }
    }
}
pg.run();
selectNode(pg);
```

## Comments

The Boolean property `latexmarkup` determines if the text should be interpreted using LaTeX syntax or not.

## Reading and Writing Data to File

---

The Application Builder provides several built-in methods for reading and writing different types of files: text files, CSV-files, Excel® files (requires LiveLink™ *for* Excel®), and binary files. These file methods are listed in the table “File Methods” on page 100.

Note that easy-to-use user-interface-based techniques for reading and writing to file are available in the Form editor of the Application Builder. It is recommended that you consider those techniques first before using the programming-based ways described in this section. For more information, see the book *Introduction to Application Builder* and “GUI Command Methods” on page 125. There, you can also find information on the various file schemes used in the Application Builder for reading and writing files when running applications in a web browser.

### READING AND WRITING TEXT AND SPREADSHEET FILES OVERVIEW

The following built-in methods are available for reading and writing text files:

- `readFile`
- `readMatrixFromFile`
- `readStringMatrixFromFile`
- `readCSVFile`
- `writeFile`
- `writeCSVFile`

In addition, you can use the low-level methods available in the class `CsReader` to read text files line by line or character by character. See the next section, “Processing Text Files using the `CsReader` and `CsWriter` Classes” on page 179, for more information.

If you have a LiveLink™ *for* Excel® license, then the following methods are available for reading and writing Microsoft Excel Workbook files:

- `readExcelFile`
- `writeExcelFile`

## INTRODUCTION TO READING FILES WITH A CSV-FILE EXAMPLE

Assume that you want to automate a certain thermal analysis of a circuit board by creating an application that reads in data from a spreadsheet. Further assume that information about the circuit board components is given by a proprietary format in a spreadsheet with columns for component type, heat dissipation, locations, and sizes. Assume that such a file looks like:

```
B,0,0,0,-1.57,350,200,1.57
B,3,30,10,0,40,10,2
C,1,100,30,0,3,10,
C,1,110,30,0,3,10,
B,4,30,30,0,40,10,2
...
C,1,200,30,0,3,10,
B,10,100,150,0,10,20,30
B,10,130,150,0,10,20,30
B,10,160,150,0,10,20,30
```

Each row of the spreadsheet represents a different component. The first column can contain a letter, either B or C, denoting that the component can be modeled as either a **Block** or a **Cylinder** primitive. The next column is the total heat dissipation within the component (measured in watts). The next three columns represent the location of the component in the global Cartesian coordinate system (measured in millimeters). Lastly, if the row contains a block component, there are three more columns that denote the width, depth, and height of the block. If the row contains a cylinder component, then there are two more columns that contain the radius and height information, respectively.

For the example shown above, the first row of the spreadsheet represents the circuit board itself, which is 1.57 mm thick and 350 mm x 200 mm. It is offset from the origin by -1.57 mm in the  $z$ -direction and does not dissipate any heat.

You can write the data in the spreadsheet out to a comma-delimited text file, also known as a CSV-file. The user interface of the application used to read the data is shown in the figure below.

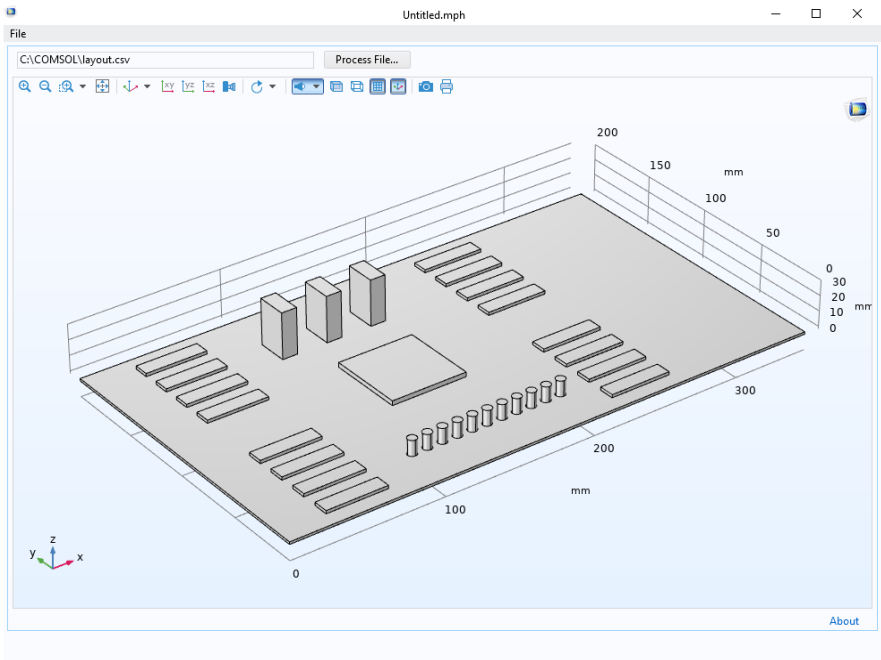

The **Settings** window for the **File Import** form object is shown in the figure below.

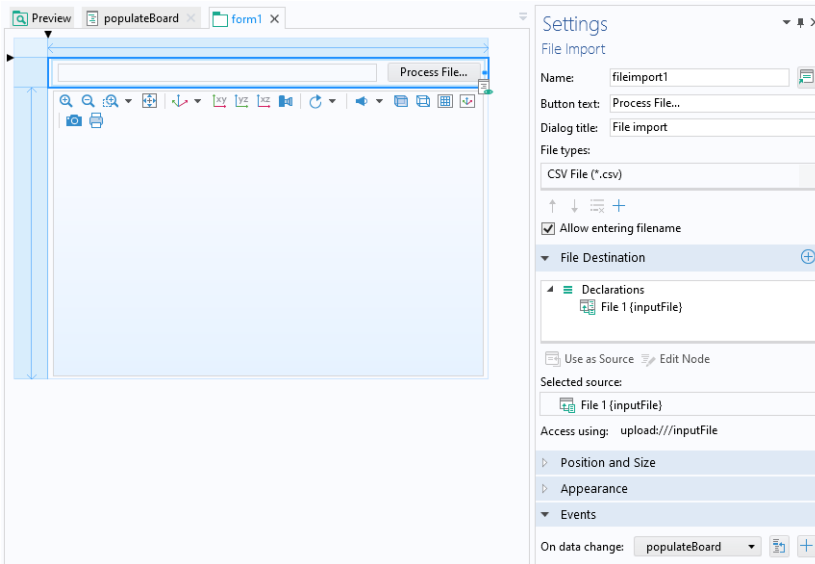

In the **Settings** window, **CSV File (\*.csv)** is added to the **File types** list. When browsing for the file, this setting will filter out any file that is not a CSV-file.

There is also a **File Declaration** called **File 1**, which is referenced by the file scheme syntax `upload:///inputFile` in the method `populateBoard`, which is used to read and process the data. The method is called as an event shown at the bottom of the **Settings** window of the **File Import** form object in the **Events** section.

Note that if you would like to open a file browser from a button or a menu item, instead of using a **File Import** object, you can create a method that calls the built-in method `importFile`; for example

```
importFile("file1");
```

assuming there is a file declaration `file1`.

The method `populateBoard` is listed below.

```
String[][] D = readCSVFile("upload:///inputFile");
model.geom("geom1").feature().clear();
for (int k = 0; k < D.length; k++) {
    if (D[k][0].equals("B")) { // Read in a block
        model.geom("geom1").create("P"+k, "Block").set("pos", new
            String[]{D[k][2], D[k][3], D[k][4]});
        model.geom("geom1").feature("P"+k).set("size", new String[]{D[k][5],
            D[k][6], D[k][7]});
    }
    else if (D[k][0].equals("C")) { // Read in a cylinder
```



```

    model.geom("geom1").create("P"+k, "Cylinder").set("pos", new
        String[]{D[k][2], D[k][3], D[k][4]});
    model.geom("geom1").feature("P"+k).set("r", D[k][5]);
    model.geom("geom1").feature("P"+k).set("h", D[k][6]);
}
model.geom("geom1").feature("P"+k).set("selresult", "on");
model.variable().remove("var"+k);
model.variable().create("var"+k).model("comp1");
model.variable("var"+k).selection().named("geom1_P"+k+"_dom");
model.variable("var"+k).set("Q", D[k][1]);
}
model.geom("geom1").run();
zoomExtents("/form1/graphics1");

```

### Comments

In the first line, the data read from the CSV-file is stored in the 2D array D. The rest of the code parses this array and populates the various parts of a model object. The application allows you to save the result as an MPH-file with variables defined for the heat sources and geometry objects defined for the components, as shown in the figures below.

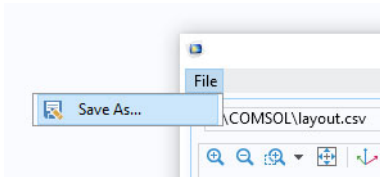

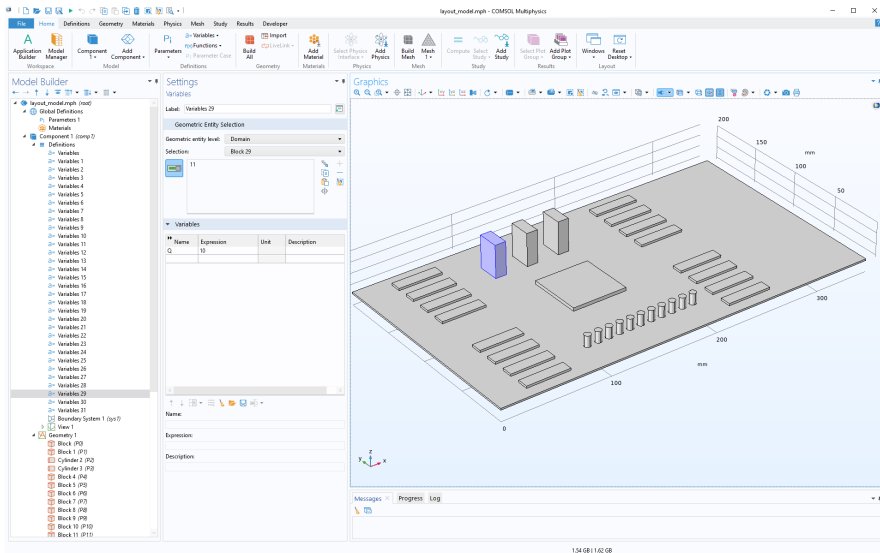

You can download the MPH-file for this app from:

<https://www.comsol.com/model/using-text-files-to-automate-model-preprocessing-46721>

## READING EXCEL FILES

The application described above can easily be extended to also read Microsoft Excel<sup>®</sup> Workbook files. Note that this requires LiveLink<sup>™</sup> for Excel<sup>®</sup>. In the **Settings** window for the **File Import** form object, you can add **Microsoft Excel**

**Workbook (\*.xlsx)** and **Microsoft Excel Workbook (\*.xls)** to the **File types** section, as shown in the figure below.

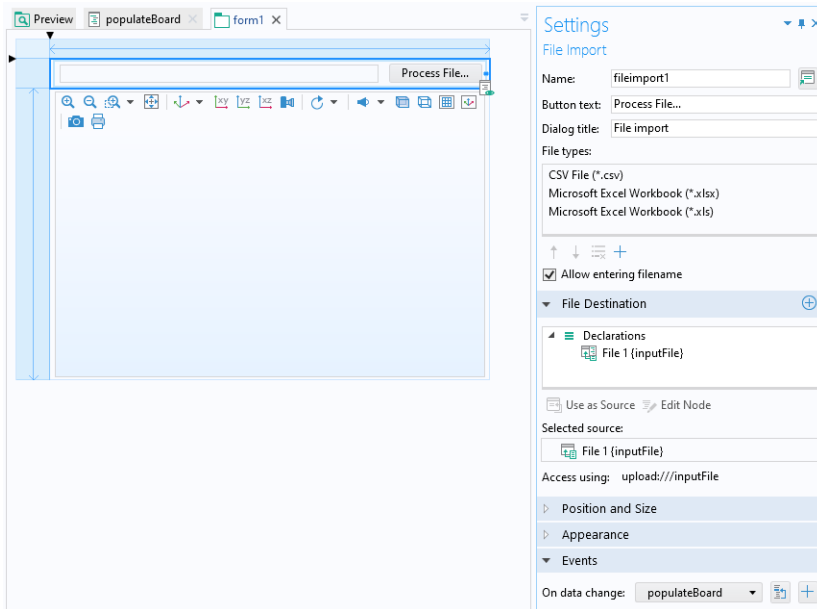

The next step is to add a few lines of code in the beginning of the method `populateBoard`, as shown below.

```
String file_name = getFile_path("upload:///inputFile");
if (file_name.endsWith(".xls") || file_name.endsWith(".xlsx"))
    D = readExcelFile("upload:///inputFile");
else if (file_name.endsWith(".csv"))
    D = readCSVFile("upload:///inputFile");
else
    error("Unknown file type.");
```

### Comments

The 2D array `D` can be defined as a global array in the **Declarations** node in the application tree. Alternatively, it can be declared as an array that is local to the method by adding the line

```
String[][] D = null;
```

before the `if` statement. Which option to choose depends on how you would like to use the 2D array data after having read the file.

The method `getFile_path` returns the full path and name of the uploaded file. The `if` statements control which method is used to read the file based on its file extension. The file extension is retrieved with the Java® method `endsWith()`,

which belongs to the `String` class. Note that you can see which methods are available for a string by typing the name of the string followed by a period and `Ctrl+Space`, as shown in the figure below.

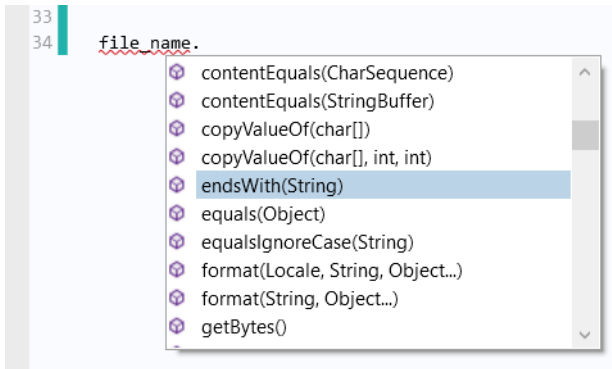

## WRITING CSV-FILES

You can write to a CSV-file using four different call syntaxes for the method `writeCSVFile`, depending on if the contents are strings or doubles and whether you would like to overwrite an already existing file or appending to its contents.

In the case above, the contents are a mix of numbers and characters, so the 2D array storing the information needs to be a string array.

Assume that we would like to move one of the components, say, the second to last one, in the file listed above. We would like to change the corresponding line in the file from

```
B, 10, 130, 150, 0, 10, 20, 30
```

to

```
B, 10, 130, 140, 0, 10, 20, 30
```

This corresponds to a change in the *y*-coordinate of one of the blocks from 150 to 140.

The following code shows how to make this change and then write data on this format, assuming that the array `D` has been declared as a global variable in the

**Declarations** node, as described above.

```
int[] sz = matrixSize(D);  
D[sz[0]-2][3] = "140.0";  
writeCSVFile("temp:///my_layout.csv", D);  
fileSaveAs("temp:///my_layout.csv");
```

## Comments

The first line stores the size of the 2D array (or matrix) `D` in a 1-by-2 array (or vector) `sz`. The second line sets the string value of the `y`-coordinate of the block of the second-to-last row in `D`.

The line

```
writeCSVFile("temp:///my_layout.csv", D);
```

writes the data to a file `my_layout.csv` in a temporary folder whose location is determined by the **Preferences** of either COMSOL Multiphysics or COMSOL Server, depending on which software is used to run the application. For example, in a typical Windows® installation of COMSOL Multiphysics, the location will be similar to

```
C:\Users\pau1\AppData\Local\Temp\
```

where the username is `pau1`.

## WRITING FILES IN GENERAL

Note that as a first step in the example above, the file is written to a temporary file using the `writeCSVFile` method. This step is done automatically by the application. In the second step, the method `fileSaveAs` opens a file browser and lets the user of the application choose the file location; for example, a folder on the computer's local file system or to a network folder. This extra step is needed in order for the application to function in a web browser. Due to the security settings of a typical web browser, the application is not permitted to automatically save a file to an arbitrary location. Instead, the application is allowed to save to a few specific locations, including the `temp` folder, whose location is specified in the **Preferences** settings. The other locations are the `user` and `common` folders, also specified in the **Preferences** settings. For more information, see the *Introduction to Application Builder*.

## WRITING EXCEL FILES

If you have licensed LiveLink™ for Excel®, then you can write to a Microsoft Excel Workbook file in a way that is similar to that of a CSV-file, with the exception that the append option is not available. The following code, corresponding to the previous CSV-file example, shows how to write to an Excel file.

```
int[] sz = matrixSize(D);
D[sz[0]-2][3] = "140.0";
writeExcelFile("temp:///my_layout.xlsx", D);
fileSaveAs("temp:///my_layout.xlsx");
```

## READING MATRIX FILES

Reading files with numerical data in matrix format is easiest when using the `readMatrixFromFile` method. This method assumes that the file has the spreadsheet format, as available in the model tree **Export** node. The example below shows a file on the spreadsheet format.

```
% Model:          my_model.mph
% Version:        COMSOL 6.0.0.278
% Date:          Nov 1 2020, 8:00
% Dimension:     1
% Nodes:         5
% Expressions:   1
% Description:   Line graph
% x              y
1.2 -0.45
1.11 -0.3
1.0440468877558806 -0.38655264416650392
1.041666666666667 -0.491666666666667
1.02 -0.15
```

The first few lines with comments start with the character `%` and are ignored by the `readMatrixFromFile` method. You can optionally omit such lines and just have the numerical part of a file read by `readMatrixFromFile`. Assume that this file is uploaded to an application using a **File Import** form object and a **File** declaration `file1`. The following code can then be used to read the data into a double array `p`.

```
double p[][] = readMatrixFromFile("upload:///file1");
```

The code below shows how to both import and visualize these points in an application that, in addition to a **File Import** form object and a **File** declaration `file`, has a form `form1` and a graphics object `graphics1`.

```
double p[][] = readMatrixFromFile("upload:///file1");
double pt[][] = transpose(p);

String pgTag = model.result().uniquetag("pg");
ResultFeature pg = model.result().create(pgTag, 2);
ResultFeature plot = pg.create("pt1", "PointData");

plot.set("pointdata", pt);
plot.run();

useGraphics(model.result(pgTag), "form1/graphics1");
```

Reading files on the spreadsheet format as a string array can be done with the method `readStringMatrixFromFile`. Also, in this case, the comment lines will be ignored. The code below shows how you can replace the first few lines in the above example using `readStringMatrixFromFile` instead of `readMatrixFromFile`.

```
String p[][] = readStringMatrixFromFile("upload:///file1");
double pt[][] = transpose(toDouble(p));
```

The method `readStringMatrixFromFile` is most useful when parts of the read file contains text.

## WRITING MATRIX FILES

To write numerical matrix data to file, you can use the method `writeFile`. Assume that you want to write a matrix of random 2D coordinate values to a file on the spreadsheet format; for example:

```
-0.3604014719437022    0.06964952539192892
-0.043869911848460674 -0.14152948348300798
0.08279441507358754   0.3101282179426158
...
0.4419748551931647    0.4139106589169702
0.15830016844077643   -0.08445989494858042
0.38236182707603905   0.4837445802317204
```

The code below shows how to do this.

```
int N = 100;
double[][] p = new double[N][2];
for (int k = 0; k < N; k++) {
    p[k][0] = Math.random()-0.5;
    p[k][1] = Math.random()-0.5;
}
writeFile("temp:///my_data.txt", p);
fileSaveAs("temp:///my_data.txt");
```

The resulting file can now be read back in and plotted by using the code of the previous example. The result, in an application, may look like the figure below.

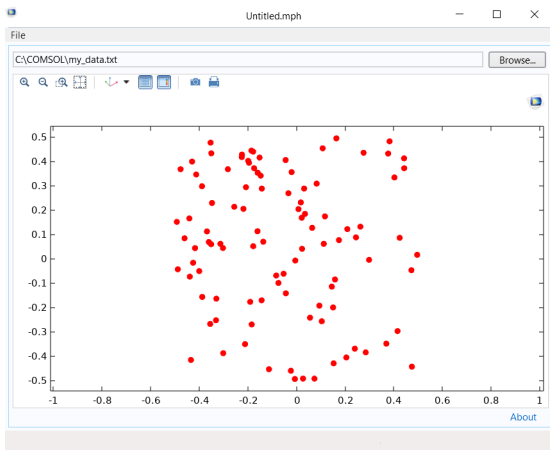

Note that you can append data to an already existing file by providing an additional Boolean input argument; for example:

```
writeFile("temp:///my_data.txt", p,true);  
fileSaveAs("temp:///my_data.txt");
```

If you would like to export a matrix with a mix of numeric and text data, you can use the `writeFile` method with a string array instead of a double array. The syntax for this case is otherwise identical to that of the double array shown in the example above.

## READING A TEXT FILE TO A STRING

For reading text files into a string, you can use the method `readFile`. A straightforward use of `readFile` is for previewing a text file; for example, before importing and parsing it, as illustrated by the example application in the figure below.

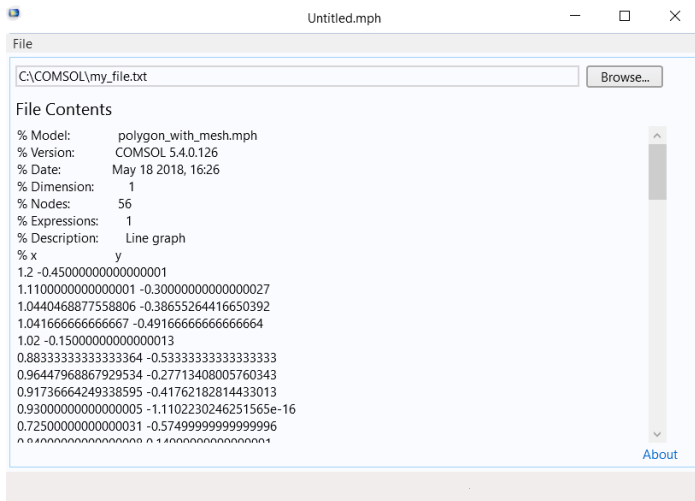



This application has two form objects: a **File Import** form object referencing a **File** declaration `file1` and a **Text** form object referencing a string `str` declared in the **Declarations** node as a global variable.

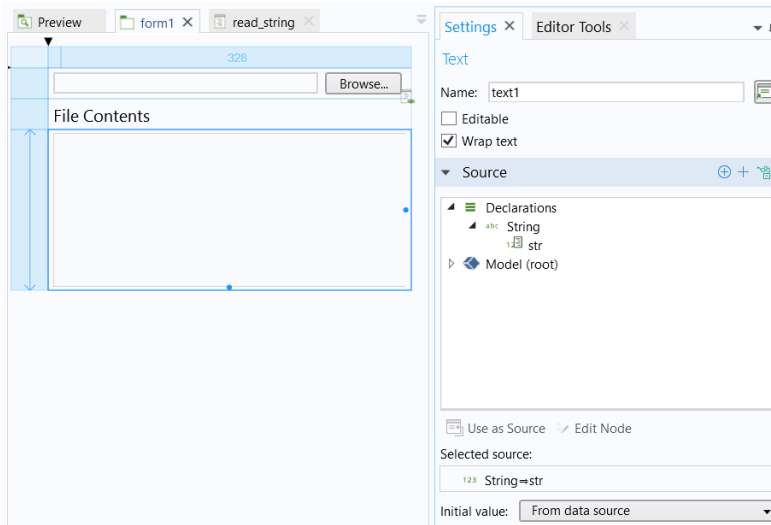

The **File Import** form object has an **Event** that calls the method `read_string` upon data change.

This method has one line of code, as shown below.

```
str = readFile("upload:///file1");
```

Since the **Text** object is referencing the global string `str`, the contents of the file are displayed in the **Text** object immediately after import.

Parsing of smaller text files can be done with `readFile` in combination with the many text processing methods available in the `String` class. However, it is often more efficient to use methods in the `CsReader` class, as described in the section “Processing Text Files using the `CsReader` and `CsWriter` Classes” on page 179, especially for larger text files. The reason is that when using the `readFile` method, the entire file is read into a string with all its contents kept in memory; whereas when using the `CsReader` class methods, only small portions of the file are kept in memory at any given time.

If you would like to parse smaller text files using `readFile`, then the built-in “String Methods” on page 147 are useful. The example code below illustrates using the built-in methods `findIn`, `substring`, `split`, as well as the regular Java® methods `System.getProperty` and `String.startsWith`. The example parses the header of a text file containing polygon information to retrieve information about the number of points of each polygon in the main body of the file (not shown) as

well as the number of properties (for example, color or material property). The header portion of the file may look like the example below.

```
Demo file for string parsing
Created on May 1st 2018
begin_header
number_of_points 4
number_of_properties 4
end_header
```

The code for parsing the header is listed below. It stores the number of points and properties in the variables `n_of_points` and `n_of_properties`, respectively. To keep things simple, no error handling is done. For example, the code assumes that there is exactly one instance of `begin_header` and `end_header`.

```
int n_of_points = 0;
int n_of_properties = 0;

String fileContents = readFile("upload:///file1");
String eol = System.getProperty("line.separator"); // find the system end of line

int headerBeginIndex = findIn(fileContents, "begin_header");
int headerEndIndex = findIn(fileContents, "end_header");

String headerContents = substring(fileContents, headerBeginIndex,
    headerEndIndex-headerBeginIndex); // Convert to string array by splitting at
    each line.
String[] headerContentsArr = split(headerContents, eol);
int ix = 1;
String[] headerRowArr = new String[2];
do {
    // Split each line at space.
    headerRowArr = split(headerContentsArr[ix], " ");

    if (headerRowArr.length == 2) {
        if (headerRowArr[0].trim().equalsIgnoreCase("number_of_points"))
            n_of_points = toInt(headerRowArr[1]);
        if (headerRowArr[0].trim().equalsIgnoreCase("number_of_properties"))
            n_of_properties = toInt(headerRowArr[1]);
    }
    ix++;
} while (ix < headerContentsArr.length);
```

The Java® `String` class has many methods for text processing. See the online Java® documentation for more information.

## WRITING A STRING TO A TEXT FILE

The following example shows how to use the method `writeFile` to write a string to file.

```
String contents = "# Created by me\r\n"
    + "# Version 1.0 of this file format \r\n"
    + "# Body follows\r\n"
    + "0 1 \r\n"
```

```

+"2 3\r\n"
+"4 5\r\n";

writeFile("temp:///my_data.txt", contents);
fileSaveAs("temp:///my_data.txt");

```

The use of the file scheme syntax `temp:///` is described above in the earlier examples of this section. The end-of-line characters of this example are for Windows®; see also “Special Characters” on page 11.

To append additional data to the same file, for example:

```

String contents_2 = "6 7\r\n"
+"8 9\r\n"
+"10 11\r\n";

```

use an additional Boolean input argument, which appends data when set to `true`:

```

writeFile("temp:///my_data.txt", contents_2, true);
fileSaveAs("temp:///my_data.txt");

```

## PROCESSING TEXT FILES USING THE `CSREADER` AND `CSWRITER` CLASSES

The most efficient and flexible way to read and write to a text file is to use the methods in the `CsReader` and `CsWriter` classes, respectively. However, using the methods of these classes is more complicated than using any of the built-in methods described above.

The `CsReader` class inherits all public methods of the abstract Java® class `Reader`. In a similar way, the `CsWriter` class inherits all public methods of the abstract Java® class `Writer`. This means that when using these classes, you get access to a large number of methods for processing text files. These methods are not documented here, but you can find a lot of information with regards to using these methods online as well as in books on Java® programming. In addition, you can see which methods are available by using code-completion `Ctrl+Space`.

## READING TEXT FILES USING THE `CSREADER` CLASS

The example code below shows how to parse the text file header of the earlier example for reading strings using the built-in method `readFile`. The header may look like:

```

Demo file for string parsing
Created on May 1st 2018
begin_header
number_of_points 4
number_of_properties 4
end_header

```

and the corresponding code is listed below (compare with the example “Reading a Text File to a String” on page 176).

```

int n_of_points = 0;
int n_of_properties = 0;

```

```

int max_header_length = 100;

CsReader reader = openFileStreamReader("upload:///file1");

String line; // Each line in the file
String[] lineArr; // The contents of each line in an array
int li = 0; // Line counter

boolean begin_header_found = false;
boolean end_header_found = false;

while (!begin_header_found && li < max_header_length && ((line =
reader.readLine()) != null)) {
    if (line.trim().startsWith("begin_header"))
        begin_header_found = true;
    li++;
}

while (begin_header_found && !end_header_found && li < max_header_length &&
((line = reader.readLine()) != null)) {
    lineArr = split(line, " ");
    if (lineArr[0].trim().equalsIgnoreCase("number_of_points"))
        n_of_points = toInt(lineArr[1]);
    if (lineArr[0].trim().equalsIgnoreCase("number_of_properties"))
        n_of_properties = toInt(lineArr[1]);
    if (line.trim().startsWith("end_header"))
        end_header_found = true;
    li++;
}
if (!begin_header_found || !end_header_found)
    error("File does not have the right format.");

```

## Comments

The line

```
CsReader reader = openFileStreamReader("upload:///file1");
```

opens a Java® character stream and assigns it to the object `reader` belonging to the class `CsReader`.

The while loop condition contains the statement

```
(line = reader.readLine()) != null)
```

which is reading a line from the character stream and storing the result in the string `line`. A line is considered to be terminated by one of the characters carriage return `\r`, line feed `\n`, or the composite `\r\n`. If there are no more lines to read, then `null` is returned.

For more information on the string methods used in this and earlier examples, including `findIn`, `substring`, and `split`, see the section “Writing a String to a Text File” on page 178.

Note that you can see which additional methods are available for the reader object by using Ctrl+Space, as shown in the figure below.

```

5 CsReader reader = openFileStreamReader("upload:///file1");
6
7 reader.
8
9
10 Str:
11 Str:
12 int
13 boo:
14 boo:
15
16 whi:
17 i:
18
19
20 }

```

By using Ctrl+Space following a string, you can see the many additional methods available for strings, including the trim method used in the example above:

```

13
14 line.
15
16 whi:
17
18
19
20 }
21
22 whi:
23
24
25

```

## WRITING TEXT FILES USING THE CSWRITER CLASS

The example of the section “Reading Matrix Files” on page 174 uses an example on the spreadsheet data format. This section contains an example that writes a file on the sectionwise format, the other primary format in COMSOL Multiphysics for saving postprocessing data. Data on the sectionwise format can, for example, be read into an **Interpolation Curve** geometry primitive. A file on the sectionwise format may look like this:

```

% Version:          COMSOL 6.0.0.278
% Date:            Nov 1 2020, 8:00
% Description:     Interpolation curve
% Coordinates

```

```

-1.1          -0.8
1.2           -0.9
0.9           1.3
-0.8         1.05
% Elements (segments)
1            2
2            3
3            4

```

The first few lines with comments start with the character % and are ignored when imported as an **Interpolation Curve**. The first section containing data starts on the line after % Coordinates. The second section containing data starts on the line after % Elements (segments). Note that the strings Coordinates and Elements (segments) are not necessary but each section containing data will be assumed to start after each block of comments, regardless of what comes after the character %.

There may be additional blocks of data when, for example, exporting **Contour** plot data.

The following example code uses a `CsWriter` stream to write interpolation curve data to a text file. A template point set `p` is copied in a circular pattern for a given radius `R` and number of copies `n_of_copies`.

```

CsWriter writer = openFileStreamWriter("temp:///my_curve.txt");

int n_of_copies = 10;
double[][] p = {{-1.2, -0.9}, {0.9, -1.1}, {1.3, 0.8}, {-0.9, 1.0}}; // template
int template_length = p.length;
double R = 10;
double px, py;
double pi = Math.PI;
String line;
int i1, i2;

String header = "% Version:\tCOMSOL 6.0.0.278\r\n"
    + "% Date:\tMay 5 2018, 8 : 00\r\n"
    + "% Description:\tInterpolation curve\r\n"
    + "% Coordinates:\r\n";

writer.append(header);

for (int j = 0; j < n_of_copies; j++) {
    for (int i = 0; i < template_length; i++) {
        px = p[i][0];
        py = p[i][1];
        px = px+R*Math.cos(2*pi*j/n_of_copies);
        py = py+R*Math.sin(2*pi*j/n_of_copies);
        line = toString(px)+"\t"+toString(py)+"\r\n";
        writer.append(line);
    }
}

writer.append("% Elements (segments):\r\n");

for (int j = 0; j < n_of_copies; j++) {

```

```

    for (int i = 0; i < template_length; i++) {
        i1 = i+1;
        i2 = (i+1)%template_length+1;
        i1 = i1+j*template_length;
        i2 = i2+j*template_length;
        line = toString(i1)+"\t"+toString(i2)+"\r\n";
        writer.append(line);
    }
}
writer.flush();
writer.close();

fileSaveAs("temp:///my_curve.txt");

```

### *Comments*

The line

```
    CsWriter writer = openFileStreamWriter("temp:///my_curve.txt");
```

opens a Java® character stream and assigns it to the object `writer` belonging to the class `CsWriter`.

The line

```
    writer.append(header);
```

appends the contents of the string `header` to the (empty) file `my_curve.txt`.

The line

```
    writer.flush();
```

writes the contents of the character stream buffer to file and empties the buffer but does not close the stream permanently. At this point, you can still write more data to the stream.

The line

```
    writer.close();
```

closes the stream permanently. If you wish to write additional data to the file, you have to open the stream again and append additional data.

Just as described above for the reader object, you can see which additional methods are available for the writer object by using Ctrl+Space, as shown in the figure below.

```

1 CsWriter writer = openFileStreamWriter("temp://my_curve.txt");
2
3
4 writer.
5
6 int append(CharSequence)
7 double append(CharSequence, int, int)
8 double append(char)
9 double checkError()
10 double close()
11 double flush()
12 String format(Locale, String, Object...)
13 int format(String, Object...)
14 String print(Object)
15 String print(String)
16
17
18
19
20
21
22
23
24
25
26
27
28
29
30
31
32
33
34
35
36
37
38
39
40
41
42
43
44
45
46
47
48
49
50
51
52
53
54
55
56
57
58
59
60
61
62
63
64
65
66
67
68
69
70
71
72
73
74
75
76
77
78
79
80
81
82
83
84
85
86
87
88
89
90
91
92
93
94
95
96
97
98
99
100
101
102
103
104
105
106
107
108
109
110
111
112
113
114
115
116
117
118
119
120
121
122
123
124
125
126
127
128
129
130
131
132
133
134
135
136
137
138
139
140
141
142
143
144
145
146
147
148
149
150
151
152
153
154
155
156
157
158
159
160
161
162
163
164
165
166
167
168
169
170
171
172
173
174
175
176
177
178
179
180
181
182
183
184
185
186
187
188
189
190
191
192
193
194
195
196
197
198
199
200
201
202
203
204
205
206
207
208
209
210
211
212
213
214
215
216
217
218
219
220
221
222
223
224
225
226
227
228
229
230
231
232
233
234
235
236
237
238
239
240
241
242
243
244
245
246
247
248
249
250
251
252
253
254
255
256
257
258
259
260
261
262
263
264
265
266
267
268
269
270
271
272
273
274
275
276
277
278
279
280
281
282
283
284
285
286
287
288
289
290
291
292
293
294
295
296
297
298
299
300
301
302
303
304
305
306
307
308
309
310
311
312
313
314
315
316
317
318
319
320
321
322
323
324
325
326
327
328
329
330
331
332
333
334
335
336
337
338
339
340
341
342
343
344
345
346
347
348
349
350
351
352
353
354
355
356
357
358
359
360
361
362
363
364
365
366
367
368
369
370
371
372
373
374
375
376
377
378
379
380
381
382
383
384
385
386
387
388
389
390
391
392
393
394
395
396
397
398
399
400
401
402
403
404
405
406
407
408
409
410
411
412
413
414
415
416
417
418
419
420
421
422
423
424
425
426
427
428
429
430
431
432
433
434
435
436
437
438
439
440
441
442
443
444
445
446
447
448
449
450
451
452
453
454
455
456
457
458
459
460
461
462
463
464
465
466
467
468
469
470
471
472
473
474
475
476
477
478
479
480
481
482
483
484
485
486
487
488
489
490
491
492
493
494
495
496
497
498
499
500
501
502
503
504
505
506
507
508
509
510
511
512
513
514
515
516
517
518
519
520
521
522
523
524
525
526
527
528
529
530
531
532
533
534
535
536
537
538
539
540
541
542
543
544
545
546
547
548
549
550
551
552
553
554
555
556
557
558
559
560
561
562
563
564
565
566
567
568
569
570
571
572
573
574
575
576
577
578
579
580
581
582
583
584
585
586
587
588
589
590
591
592
593
594
595
596
597
598
599
600
601
602
603
604
605
606
607
608
609
610
611
612
613
614
615
616
617
618
619
620
621
622
623
624
625
626
627
628
629
630
631
632
633
634
635
636
637
638
639
640
641
642
643
644
645
646
647
648
649
650
651
652
653
654
655
656
657
658
659
660
661
662
663
664
665
666
667
668
669
670
671
672
673
674
675
676
677
678
679
680
681
682
683
684
685
686
687
688
689
690
691
692
693
694
695
696
697
698
699
700
701
702
703
704
705
706
707
708
709
710
711
712
713
714
715
716
717
718
719
720
721
722
723
724
725
726
727
728
729
730
731
732
733
734
735
736
737
738
739
740
741
742
743
744
745
746
747
748
749
750
751
752
753
754
755
756
757
758
759
760
761
762
763
764
765
766
767
768
769
770
771
772
773
774
775
776
777
778
779
780
781
782
783
784
785
786
787
788
789
790
791
792
793
794
795
796
797
798
799
800
801
802
803
804
805
806
807
808
809
810
811
812
813
814
815
816
817
818
819
820
821
822
823
824
825
826
827
828
829
830
831
832
833
834
835
836
837
838
839
840
841
842
843
844
845
846
847
848
849
850
851
852
853
854
855
856
857
858
859
860
861
862
863
864
865
866
867
868
869
870
871
872
873
874
875
876
877
878
879
880
881
882
883
884
885
886
887
888
889
890
891
892
893
894
895
896
897
898
899
900
901
902
903
904
905
906
907
908
909
910
911
912
913
914
915
916
917
918
919
920
921
922
923
924
925
926
927
928
929
930
931
932
933
934
935
936
937
938
939
940
941
942
943
944
945
946
947
948
949
950
951
952
953
954
955
956
957
958
959
960
961
962
963
964
965
966
967
968
969
970
971
972
973
974
975
976
977
978
979
980
981
982
983
984
985
986
987
988
989
990
991
992
993
994
995
996
997
998
999
1000

```

You can import the resulting interpolation data as an **Interpolation Curve** by selecting the **Sectionwise** option for **Data format**. This can be done for a 2D geometry object or for a **Work Plane** in 3D. The figure below shows the data imported to a 2D model.

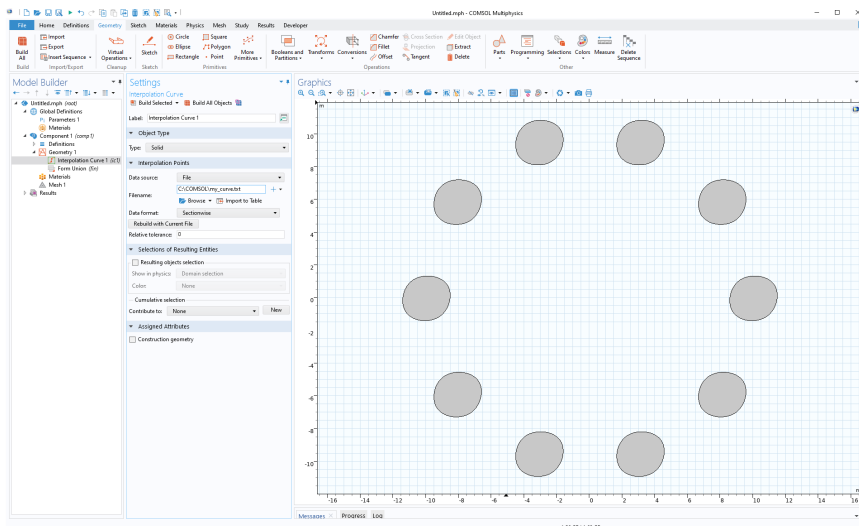



## WRITING BINARY FILES

You write data to a binary file by using the methods of the class `CsBinaryWriter` in a way that is somewhat similar to that of writing text using `CsWriter`. However, instead of writing strings and characters, you are writing bytes. To see how many bytes each data type requires, see the table in the section “Primitive Data Types” on page 8.

The example code below writes random 3D point data to a binary file. Each point coordinate is stored as a `double` and takes 8 bytes to store. The first 4 bytes of the file stores the number of points in the file as an `int`.

To conveniently convert between the regular data types, such as `double`, `int`, and `byte` arrays, the Java® library method `java.nio.ByteBuffer` is needed. This method is not part of the standard methods available in the Method Editor and you need to use the fully qualified Java® class name `java.nio.ByteBuffer`, as shown in the example code below.

```
byte[] bytes8 = new byte[8];
byte[] bytes4 = new byte[4];
CsBinaryWriter bwriter =
openBinaryFileStreamWriter("temp:///my_binary_file.dat");
int N = 1000;
java.nio.ByteBuffer.wrap(bytes4).putInt(N);
bwriter.write(bytes4);

double p[][] = new double[N][3];
for (int k = 0; k < N; k++) {
    p[k][0] = Math.random();
    java.nio.ByteBuffer.wrap(bytes8).putDouble(p[k][0]);
    bwriter.write(bytes8);

    p[k][1] = Math.random();
    java.nio.ByteBuffer.wrap(bytes8).putDouble(p[k][1]);
    bwriter.write(bytes8);

    p[k][2] = Math.random();
    java.nio.ByteBuffer.wrap(bytes8).putDouble(p[k][2]);
    bwriter.write(bytes8);
    bwriter.flush();
}
bwriter.close();
fileSaveAs("temp:///my_binary_file.dat");
```

### *Comments*

The first two lines declare byte arrays of size 8 and 4, respectively

The line

```
CsBinaryWriter bwriter =
openBinaryFileStreamWriter("temp:///my_binary_file.dat");
```

opens a Java® byte stream.

The line

```
int N = 1000; // The number of points
```

denotes the number of points written to file.

The line

```
ByteBuffer.wrap(bytes4).putInt(N);
```

uses the imported `ByteBuffer` method to convert the integer `N` to a byte array `bytes4` of length 4.

The line

```
bwriter.write(bytes4);
```

writes the value of `N` to file.

The `for`-loop creates `N` points and writes each  $x$ -,  $y$ -, and  $z$ -coordinate as doubles using a byte array `bytes8` of length 8.

The line

```
bwriter.flush();
```

empties the byte buffer and the last two lines

```
bwriter.close();  
fileSaveAs("temp:///my_binary_file.dat");
```

close the byte stream and display a file browser to the user to select a location to save the binary file.

## READING BINARY FILES

Based on the data format of the previous example, the code below reads a corresponding binary file and plots the points as 3D point data.

```
byte[] bytes8 = new byte[8];  
byte[] bytes4 = new byte[4];  
CsBinaryReader breader = openBinaryFileStreamReader("upload:///file1");  
  
breader.read(bytes4);  
int N = java.nio.ByteBuffer.wrap(bytes4).getInt();  
  
double p[][] = new double[N][3];  
  
for (int k = 0; k < N; k++) {  
    breader.read(bytes8);  
    p[k][0] = java.nio.ByteBuffer.wrap(bytes8).getDouble();  
  
    breader.read(bytes8);  
    p[k][1] = java.nio.ByteBuffer.wrap(bytes8).getDouble();  
  
    breader.read(bytes8);  
    p[k][2] = java.nio.ByteBuffer.wrap(bytes8).getDouble();  
  
}  
breader.close();
```

```

double pt[][] = transpose(p);

String pgTag = model.result().uniquetag("pg");
ResultFeature pg = model.result().create(pgTag, 3);
ResultFeature plot = pg.create("pt1", "PointData");

plot.set("pointdata", pt);
plot.run();

useGraphics(model.result(pgTag), "form1/graphics1");

```

### Comments

The line

```
CsBinaryReader breader = openBinaryFileStreamReader("upload:///file1");
```

opens a Java® byte stream based on a **File** declaration `file1`, typically referenced in a **File Browser** form object, as in the earlier examples on reading text files.

The two lines

```

breader.read(bytes4);
int N = ByteBuffer.wrap(bytes4).getInt();

```

read the first 4 bytes and convert them to an `int N`.

The following `for`-loop reads chunks of 8 bytes into the byte array `bytes8`, converts them and stores the results in a 2D double array `p`.

The line

```
breader.close();
```

closes the byte stream.

The last section of the example code plots the data and is similar to the example in “Reading Matrix Files” on page 174.

### ADDITIONAL COMMENTS ON READING AND WRITING BINARY FORMATS

When processing binary files, there are two formats in which bytes can be stored: little endian and big endian, respectively. By default, Java® uses the big endian format. For example, the line

```
p[k][2] = ByteBuffer.wrap(bytes8).getDouble();
```

is the same as

```
p[k][2] = ByteBuffer.wrap(bytes8).order(ByteOrder.BIG_ENDIAN).getDouble();
```

In case the format you are reading is on the little endian format, the corresponding line should be

```
p[k][2] = ByteBuffer.wrap(bytes8).order(ByteOrder.LITTLE_ENDIAN).getDouble();
```

# Converting Interpolation Curve Data

The following method converts a geometry **Interpolation Curve** to an **Interpolation** function (by creating an interpolation table). The method demonstrates extracting geometry information from the underlying parameterization of an edge. The edge does not have to be an **Interpolation Curve** but can be any single edge.

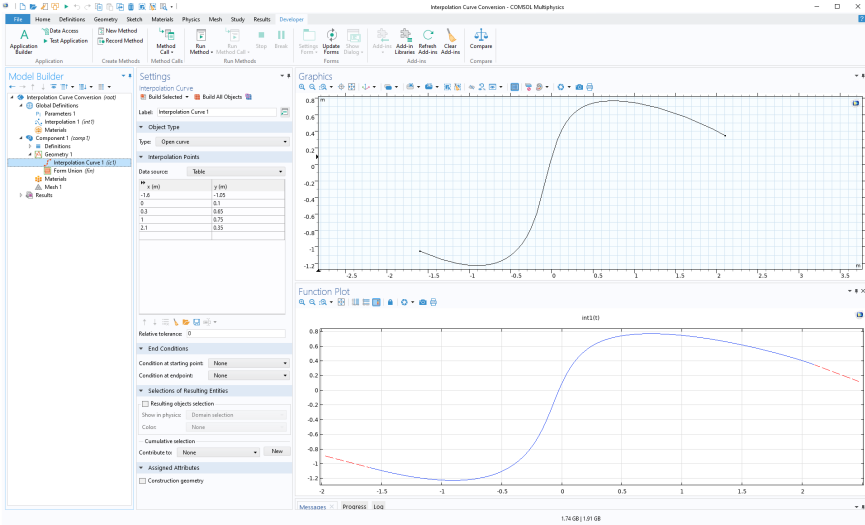

The curve is checked for being monotonous, which is required in order to be able to convert to an interpolation function. Note that since an interpolation curve is represented using splines, even though the interpolation points form a monotonous sequence, the resulting curve may not; hence, the second consistency check (the first check can potentially be skipped).

```
// Convert using N points
int N = 100;
double monoTol = 1e-6;
int edgeNum=1;

// Update and get geometry information
model.component("comp1").geom("geom1").run("fin");
GeomSequence geom1 = model.component("comp1").geom("geom1");
GeomFeature ic1 = geom1.feature("ic1");
double[][] curvePoints = ic1.getDoubleMatrix("table");

int len = curvePoints.length;
double minX = curvePoints[0][0];
double maxX = curvePoints[len-1][0];
double scale = maxX-minX;
double scaledTol = monoTol*scale;
```

```

for (int i = 1; i < len; i++) {
  if ((curvePoints[i][0]-curvePoints[i-1][0]) < scaledTol) {
    error("Curve needs to be a function curve with monotonously growing x
      coordinates.");
  }
}

double minMaxS[] = geom1.edgeParamRange(edgeNum);
double minS = minMaxS[0];
double maxS = minMaxS[1];

double sList[] = new double[N];
for (int k = 0; k < N; k++) {
  sList[k] = (double) (N-1-k)/(double) (N-1)*minS+k/(double) (N-1)*maxS;
}
double[][] XY = geom1.edgeX(1, sList);

for (int j = 1; j < N; j++) {
  if ((XY[j][0]-XY[j-1][0]) < scaledTol) {
    error("Curve needs to be a function curve with monotonously growing x
      coordinates.");
  }
}

// Create interpolation table
model.func().create("int1", "Interpolation");
with(model.func("int1"));
  set("funcname", "int1");
  set("interp", "cubicspline");
  set("extrap", "linear");
endwith();

model.func("int1").set("table", toString(XY));

```

### Comments

The method assumes that there is a geometry sequence `geom1` with an interpolation curve `ic1`. It further assumes that there are no other geometry features and that the geometry object has a single edge. The integer `N` determines how granular the interpolation table should be. It is assumed that there is only one edge in the geometry sequence (`edgeNum`). Note that the curve parameter range may not be the unit interval (`minS` does not have to be `0.0` and `maxS` does not have to be `1.0`). To run the method more than once, you can create a `cleanup` method that contains the lines:

```

model.func().remove("int1");
model.result().remove("pg1");

```

for removing previously created model tree nodes.

## Plotting Points on a Parametric Surface

The following method retrieves coordinate values for a regularly sampled parametric surface and plots the corresponding points using a **Point Data** plot. The method demonstrates extracting geometry information from the underlying parameterization of a surface. The example assumes that a parametric surface geometry object has already been created.

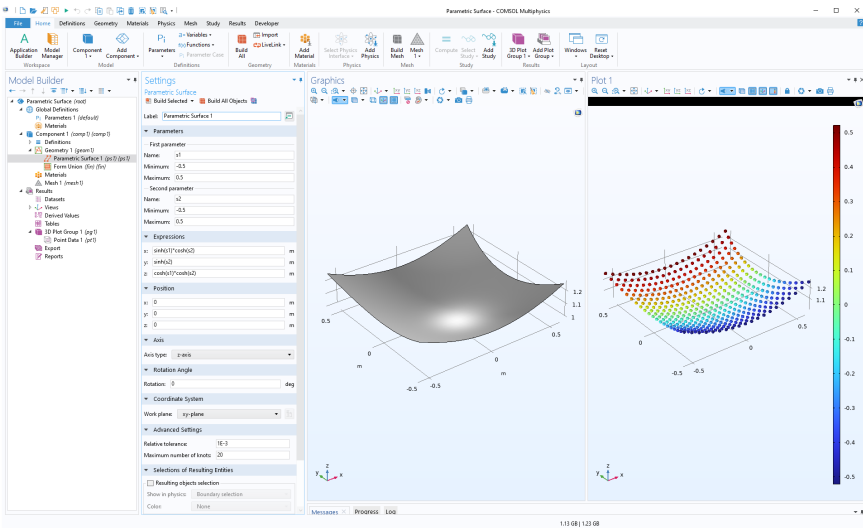

```
// Sample and plot N-by-N points on a parametric surface
int N = 20;
int faceNum = 1;

// Update and get geometry information
model.component("comp1").geom("geom1").run("fin");
GeomSequence geom1 = model.component("comp1").geom("geom1");
GeomFeature ps1 = geom1.feature("ps1");

double minMaxS[] = geom1.faceParamRange(faceNum);
double minS1 = minMaxS[0];
double maxS1 = minMaxS[1];
double minS2 = minMaxS[2];
double maxS2 = minMaxS[3];

double s1List[] = new double[N];
double s2List[] = new double[N];
for (int k = 0; k < N; k++) {
    s1List[k] = (double) (N-1-k)/(double) (N-1)*minS1+k/(double) (N-1)*maxS1;
    s2List[k] = (double) (N-1-k)/(double) (N-1)*minS2+k/(double) (N-1)*maxS2;
}
```

```

double s12List[][] = new double[N*N][2];
for (int i = 0; i < N; i++) {
    for (int j = 0; j < N; j++) {
        s12List[i+N*j][0] = s1List[i];
        s12List[i+N*j][1] = s2List[j];
    }
}
double[][] XY = geom1.faceX(faceNum, s12List);

// Plot points
String pgTag = model.result().uniquetag("pg");
ResultFeature pg = model.result().create(pgTag, 3);
ResultFeature plot = pg.create("pt1", "PointData");
double[][] p = new double[3][N*N];
double[] color = new double[N*N];
for (int i = 0; i < N*N; i++) {
    p[0][i] = XY[i][0];
    p[1][i] = XY[i][1];
    p[2][i] = XY[i][2];
    color[i] = p[1][i];
}
plot.set("pointdata", p)
    .set("colordata", color)
    .set("coloring", "colortable")
    .set("sphereradiusscale", 1);
plot.run();
selectNode(pg);

```

## Using Selections for Editing Geometry Objects

---

The following method generates a plate with an array of cylinders. The cylinders may be used, for example, in a difference operation to create an array of holes in the plate.

```

GeomSequence geom = model.component("comp1").geom("geom1");
geom.create("blk1", "Block");
geom.feature("blk1").set("size", new int[]{10, 10, 1});
geom.create("start_cyl1", "Cylinder");
geom.feature("start_cyl1").set("pos", new double[]{2.5, 2.5, 0});
geom.create("arr1", "Array");
geom.feature("arr1").selection("input").set("start_cyl1");
geom.feature("arr1").set("fullsize", new int[]{2, 2, 1});
geom.feature("arr1").set("displ", new int[]{5, 5, 0});
geom.run("arr1");

```

The resulting geometry is shown in the figure below.

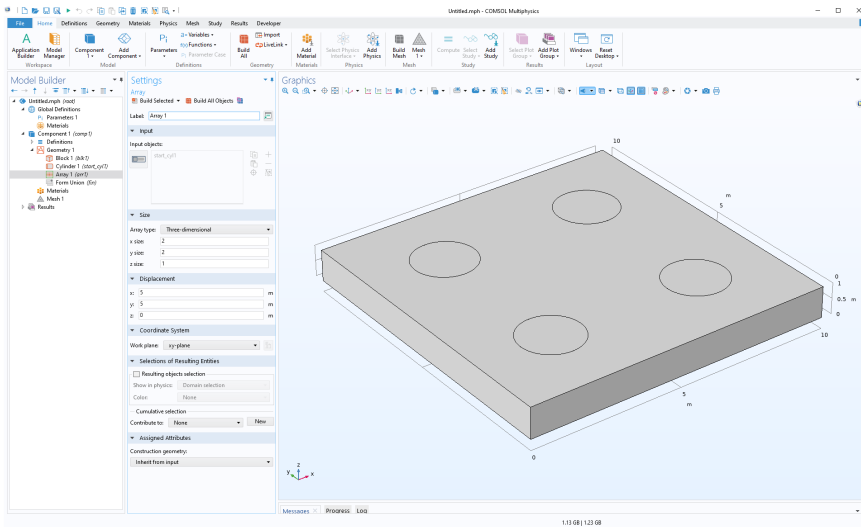

Assume now that the resulting geometry, from the previous step, corresponds to an imported geometry object and that you would like to replace the cylinders with larger cylinders before subtracting and generating the holes. Furthermore, assume that the cylinder objects are generated by an external software in such a way that, although you know these objects are cylinders, they are represented as generic geometry objects with no information on radius, height, or position. The following method finds the array of cylinders, extracts coordinate information for each cylinder, deletes the cylinders, creates a new array of wider cylinders, and



finally subtracts the cylinders from the plate. The resulting geometry is shown in the figure below.

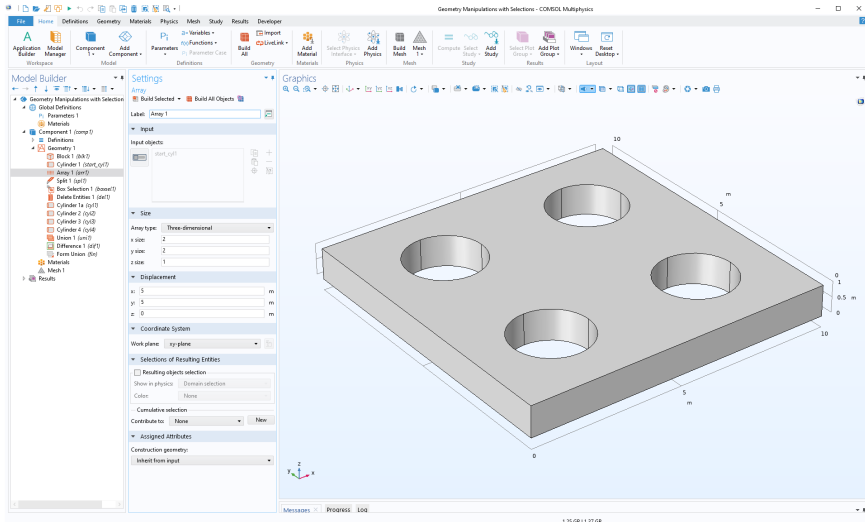

The method exemplifies retrieval of geometry object names, coordinate information, and the use of selections. To start from another geometry object (which is also necessarily a plate with cylinders), you can replace the string tag in the variable `plateAndCylinders` accordingly.

```
double selTol = 1e-2; // Selection tolerance
double newR = 1.25; // New cylinder radius
double newH = 1; // New cylinder height
double plateThickness = 1; // Plate thickness
String plateAndCylinders = "arr1";

// Update and split geometry
model.component("comp1").geom("geom1").run("fin");
GeomSequence geom = model.component("comp1").geom("geom1");
geom.run(plateAndCylinders);
geom.create("spl1", "Split");
geom.feature("spl1").selection("input").set(plateAndCylinders);
geom.run("spl1");

// Find extents of geometry in x,y,z directions
double[] bbox = geom.getBoundingBox();
double MinX = bbox[0];
double MaxX = bbox[1];
double MinY = bbox[2];
double MaxY = bbox[3];
double MinZ = bbox[4];
double MaxZ = bbox[5];

// Define scaled coordinate tolerance
```

```

double scale = Math.max(Math.max(MaxX-MinX, MaxY-MinY), MaxZ-MinZ);
double scaleSelTol = scale*scaleSelTol;

// Create box selection based on geometry extents
geom.create("boxsel1", "BoxSelection");
with(geom.feature("boxsel1"));
// Select boundaries inside box in X-Y direction using tolerance
set("xmin", MinX+scaleSelTol);
set("xmax", MaxX-scaleSelTol);
set("ymin", MinY+scaleSelTol);
set("ymax", MaxY-scaleSelTol);
set("zmin", MinZ-scaleSelTol);
set("zmax", MaxZ+scaleSelTol);
set("condition", "inside");
set("entitydim", -1); // Select objects
endwith();
geom.run("boxsel1");

// Get object names
String[] so = geom.selection("boxsel1").objects();
int nso = so.length;

// Extract cylinder parameters
double[] MinXC = new double[nso];
double[] MaxXC = new double[nso];
double[] MinYC = new double[nso];
double[] MaxYC = new double[nso];
double[] MinZC = new double[nso];
double[] MaxZC = new double[nso];
double[] bBoxC = new double[6];
for (int i = 0; i < nso; i++) {
    bBoxC = geom.obj(so[i]).getBoundingBox();
    MinXC[i] = bBoxC[0];
    MaxXC[i] = bBoxC[1];
    MinYC[i] = bBoxC[2];
    MaxYC[i] = bBoxC[3];
    MinZC[i] = bBoxC[4];
    MaxZC[i] = bBoxC[5];
}

double[] radius = new double[nso];
double[] xc = new double[nso];
double[] yc = new double[nso];
double[] zc = new double[nso];
double[] hc = new double[nso];

double ry;
double tol = scale*1e-6; // Tolerance check for skew cylinders, optional
consistency check
for (int i = 0; i < nso; i++) {
    xc[i] = (MaxXC[i]+MinXC[i])/2;
    yc[i] = (MaxYC[i]+MinYC[i])/2;
    zc[i] = (MaxZC[i]+MinZC[i])/2;
    hc[i] = MaxZC[i]-MinZC[i];
    radius[i] = (MaxXC[i]-MinXC[i])/2;
    ry = (MaxYC[i]-MinYC[i])/2;
}

```

```

    if (Math.abs(radius[i]-ry) > tol)
        error("Object is not a circular cylinder.");
}

// Delete all cylinder objects
geom.create("del1", "Delete");
geom.feature("del1").selection("input").init();
geom.feature("del1").selection("input").set(so);
geom.run("del1");

// Add new cylinders
String[] cylname = new String[nso];
for (int i = 0; i < nso; i++) {
    cylname[i] = "cyl"+toString(i+1);
    geom.create(cylname[i], "Cylinder");
    with(geom.feature(cylname[i]));
        set("r", newR);
        set("h", newH+2*scaleSelTol);
        set("pos", new double[] {xc[i], yc[i], plateThickness-2*zc[i]-scaleSelTol});
    endwhile();
}

// Combine all cylinders into one object
geom.create("uni1", "Union");
geom.feature("uni1").selection("input").set(cylname);
geom.run("uni1");

// Difference between all objects and cylinders
geom.create("dif1", "Difference");
String[] objs = geom.objectNames();
geom.feature("dif1").selection("input").set(objs);
geom.feature("dif1").selection("input2").set("uni1");
geom.run("dif1");

```

### Comments

The method assumes that the input geometry objects have the same structure as the plate with cylinders example above. Note that to clear the geometry sequence, you can create a method with the line

```
model.component("comp1").geom("geom1").feature().clear();
```

This can be useful if you are running the main method from above repeatedly, since you need to clear the geometry sequence before each run.

The first of the lines

```
geom.feature("del1").selection("input").init();
geom.feature("del1").selection("input").set(so);
```

initializes the selection to be empty of type object. The second line then selects all objects with names in the array so. In general, a call to `init()` without input argument means that the selection is for objects and `init(n)`, where `n=0,1,2`, or `3`, means that the selection is for points, edges, faces, and domains, respectively.

Note that in some cases  $n=-1$  is used to denote the object level (instead of an empty input argument); see the *Programming Reference Manual*. The figure below shows an example based on a larger array of cylinders.

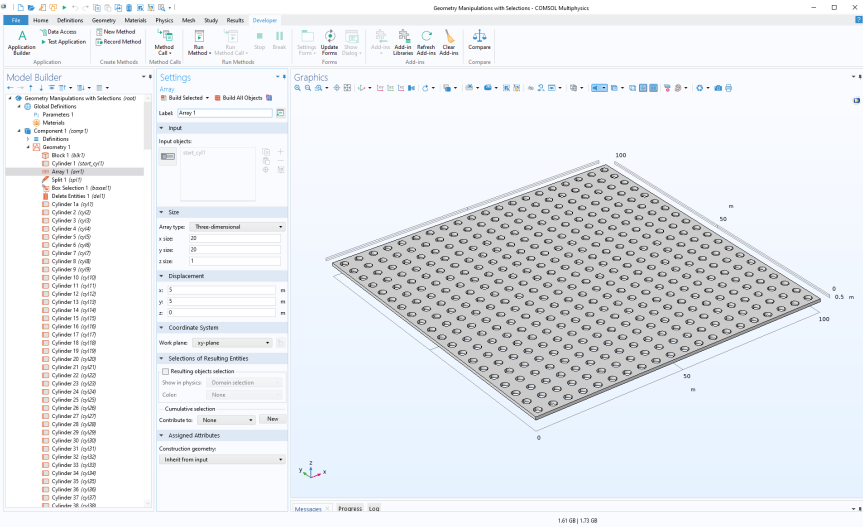

## Recursion and Recursively Defined Geometry Objects

Methods can support recursion by having a function calling itself in a recursive loop. The following examples create recursive CAD geometry models of a Sierpinski carpet in 2D and a Menger sponge in 3D.

### Sierpinski Carpet

The following method, `create_carpet`, initiates the recursion to a certain recursive level according to a user-defined **Parameter** `msLevel`, defined under **Global Definitions** in the **Model Builder**. It sets a limit at 5 levels in order to avoid creating an exceedingly large geometry. The method assumes that you have created a 2D Component and that you have declared an integer scalar variable `counter`.

```
int level = (int) model.param().evaluate("msLevel");
if (level < 1)
    error("Carpet level needs to be at least 1.");
if (level > 5)
    error("Carpet level needs to be at most 5.");
counter = 0;
model.component("comp1").geom("geom1").feature().clear();
```

```

model.component("comp1").geom("geom1").autoRebuild("off");
double cx0 = 0, cy0 = 0;
double si0 = 1;
carpet(level, cx0, cy0, si0);
model.component("comp1").geom("geom1").runPre("fin");

```

The method `create_carpet` in turn calls the main recursive function `carpet`, listed below, using four input arguments for the recursion level, the center  $x$ - and  $y$ -coordinates, and the current side length.

The input arguments are defined in the method's **Settings** window, as shown below.

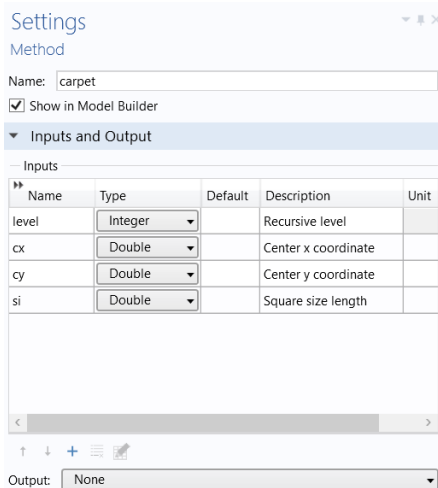

The code for the method `carpet` is shown below.

```

int l = level;
double posx, posy, si1;
String strix;
int l1;
for (int i = 0; i < 3; i++) {
    for (int j = 0; j < 3; j++) {
        posx = cx+i*si-si;
        posy = cy+j*si-si;
        strix = toString(i)+toString(j);
        if ((Math.abs((i-1))+Math.abs((j-1))) > 0) {
            if (l == 1) {
                counter = counter+1;
                model.component("comp1").geom("geom1").create("sq"+strix+"C"+
                    toString(counter), "Square");
                with(model.component("comp1").geom("geom1").feature("sq"+strix+"C"+
                    toString(counter)));
                set("base", "center");
                set("size", new double[]{si});
                set("pos", new double[]{posx, posy});
            }
        }
    }
}

```

```

endwith();
model.component("comp1").geom("geom1").feature("sq"+strix+"C"+
    toString(counter)).label("Square"+strix+"C"+toString(counter));
} else {
l1 = l1-1;
si1 = si1/3;
carpet(l1, posx, posy, si1);
}
}
}
}
}

```

The figure below shows the resulting geometry for a level-3 carpet.

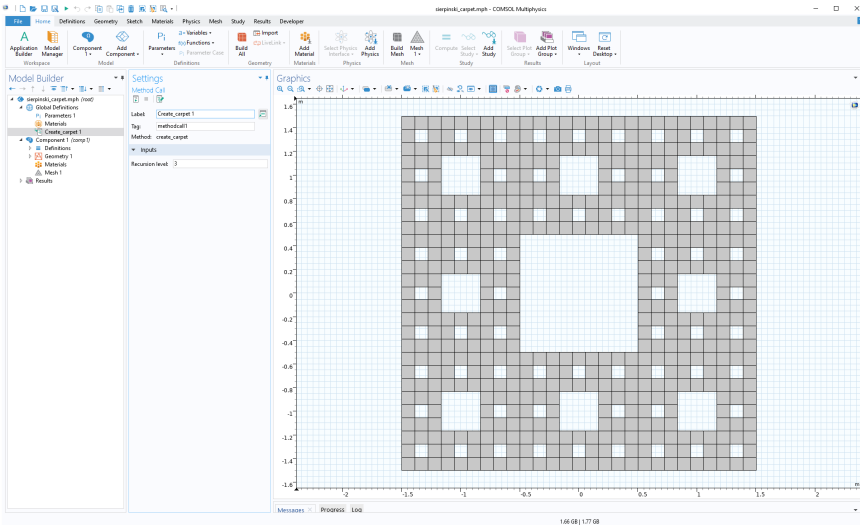

Note that the number of square geometry objects defined for the level 3 carpet is 512. The number of geometry objects for a level- $N$  carpet is  $8^N$ . This means that for the maximum level 5 set by the method `create_carpet`, the resulting geometry has 32,768 geometry objects.

### Menger Sponge

The methods for the Sierpinski carpet readily generalize to 3D. However, in 3D, you need to be careful not to generate more objects than your computer can handle. The method assumes that you have created a 3D Component and that you have declared an integer scalar variable counter.

The following method, `create_sponge`, initiates the recursion.

```

int level = (int) model.param().evaluate("mslevel");
if (level < 1)
    error("Sponge level needs to be at least 1.");
if (level > 3)
    error("Sponge level needs to be at most 3.");

```

```

counter = 0;
model.component("comp1").geom("geom1").feature().clear();
model.component("comp1").geom("geom1").autoRebuild("off");
double cx0 = 0, cy0 = 0, cz0 = 0;
double si0 = 1;
sponge(level, cx0, cy0, cz0, si0);
model.component("comp1").geom("geom1").runPre("fin");

```

The method `sponge`, shown below, is called by the above method and recursively creates a Menger sponge.

```

int l = level;
double posX, posY, posz, si1;
String strix;
int l1;
for (int i = 0; i < 3; i++) {
  for (int j = 0; j < 3; j++) {
    for (int k = 0; k < 3; k++) {
      posX = cx+i*si-si;
      posY = cy+j*si-si;
      posz = cz+k*si-si;
      strix = toString(i)+toString(j)+toString(k);
      if ((Math.abs((i-1))+Math.abs((j-1))+Math.abs((k-1))) > 1) {
        if (l == 1) {
          counter = counter+1;
          model.component("comp1").geom("geom1").create("blk"+strix+"C"+
            toString(counter), "Block");
          with(model.component("comp1").geom("geom1").feature("blk"+strix+"C"+
            toString(counter)));
          set("base", "center");
          set("size", new String[]{toString(si), toString(si),
            toString(si)});
          set("pos", new double[]{posx, posY, posz});
          endwith();
          model.component("comp1").geom("geom1").feature("blk"+strix+"C"+
            toString(counter)).label("Block"+strix+"C"+toString(counter));
        } else {
          l1 = l-1;
          si1 = si/3;
          sponge(l1, posX, posY, posz, si1);
        }
      }
    }
  }
}
}
}
}

```

The figure below shows the resulting geometry for a level-2 sponge.

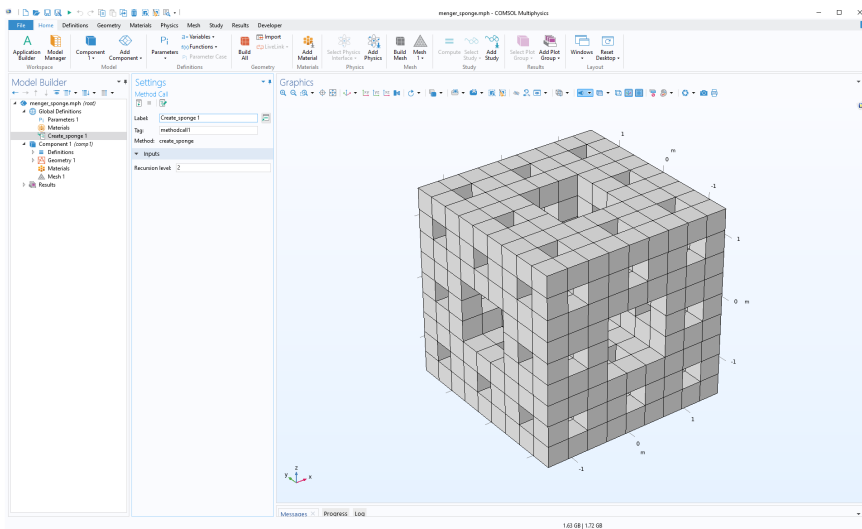

In this case, the number of geometry objects grows with the level  $N$  as  $20^N$  and the level-2 sponge shown above has 400 block geometry objects.

Note that if you have any of the add-on products for additional CAD functionality, you can export these geometry objects on standard CAD formats. Without add-on products, you can export the meshed geometry to any of the supported mesh formats.

## Mesh Information and Statistics

You can retrieve a variety of mesh information and statistical quantities, such as element quality, the total number of elements, the total mesh volume, and so on. The figure below shows part of an application displaying such information.

Number of elements:	79492
Tet min quality:	0.1405
Tet mean quality:	0.6532
Tet min volume:	2.815E-13
Mesh volume:	6.354E-6

Assuming that you would like to link the various mesh quantities to variables declared under the **Declarations** node, the corresponding method code would include the following lines of code:



```

a = model.component("comp1").mesh("mesh1").getNumElem();
b = model.component("comp1").mesh("mesh1").getMinQuality("tet");
c = model.component("comp1").mesh("mesh1").getMeanQuality("tet");
d = model.component("comp1").mesh("mesh1").getMinVolume("tet");
e = model.component("comp1").mesh("mesh1").getVolume("tet");

```

For more information on available mesh quantities, see the *COMSOL Multiphysics Programming Reference Manual*.

## Accessing Higher-Order Finite Element Nodes

The extended mesh data structure contains information related to the finite element method including, for example, the placement of higher-order element nodes. The extended mesh information is contained in the class `XmeshInfo` and provides information about the numbering of elements, nodes, and degrees of freedom (DOFs) in the extended mesh and in the matrices returned by the `Assemble` feature and the solvers. For detailed information on `XmeshInfo`, see the *Programming Reference Manual*.

The following example method illustrates how to use the extended mesh information to plot higher-order nodes in a few important special cases. Note that general functionality for this is built-in when creating a **Mesh Plot** under **Results**. The example below covers cases with one model component, one geometry, and a subset of physics combinations. If you apply it to other cases, you will get an error message.

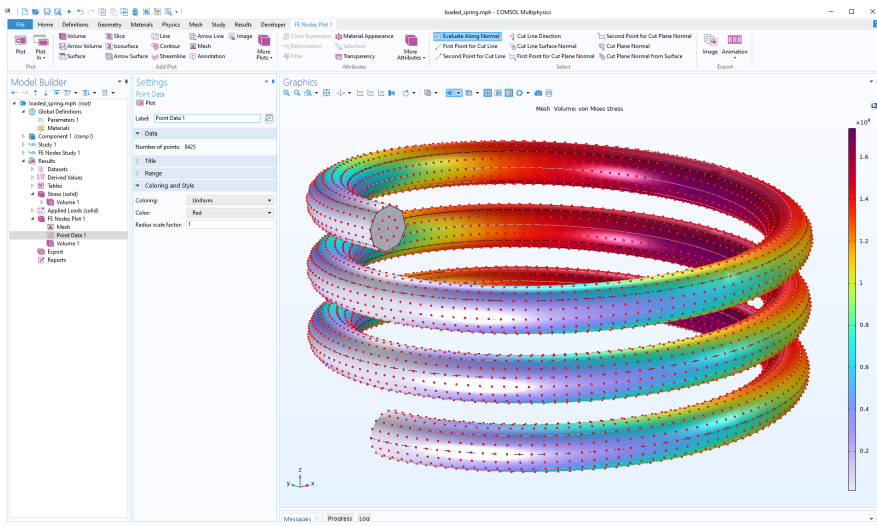

// Note that this method is only implemented for one component and one geometry and does not work for all physics combinations.

```
String stdTag = model.study().uniquetag("stdfe");
model.study().create(stdTag);
model.study(stdTag).label("FE Nodes Study "+stdTag.substring(5));
model.study(stdTag).showAutoSequences("sol");
String solTag = model.sol().uniquetag("sol");
model.sol().create(solTag);
model.sol(solTag).create("st1", "StudyStep");
model.sol(solTag).create("v1", "Variables");

SolverFeature step = model.sol(solTag).feature("v1");

XmeshInfo xmi = step.xmeshInfo();
try {
    XmeshInfoNodes testnodes = xmi.nodes();
} catch (Exception e) {
    error("Cannot access finite element data. Only implemented for one geometry and stationary studies.");
}

XmeshInfoNodes mynodes = xmi.nodes();
double[][] coords = mynodes.gCoords();
int[] coordsize = matrixSize(coords);

int sdim = 0;
if (coordsize[0] == 3) {
    sdim = 3;
} else if (coordsize[0] == 2) {
    sdim = 2;
} else
    error("The geometry of the first component is not 2D or 3D.");

String mesh = "mesh"+stdTag;
model.result().dataset().create(mesh, "Mesh");

String pgTag = model.result().uniquetag("pgfe");
ResultFeature pg = model.result().create(pgTag, sdim);
model.result(pgTag).label("FE Nodes Plot "+pgTag.substring(4));
String nodes = pgTag;
model.result(nodes).create("mesh", "Mesh");
if (sdim == 3) {
    with(model.result(nodes).feature("mesh"));
        set("data", mesh);
        set("meshdomain", "volume");
    endwith();
} else {
    with(model.result(nodes).feature("mesh"));
        set("data", mesh);
        set("meshdomain", "surface");
    endwith();
}

with(model.result(nodes).feature("mesh"));
    set("elemcolor", "none");
```

```

    set("wireframecolor", "gray");
    set("elemscale", 0.999);
endwith();

with(model.result(nodes));
    set("edges", true);
    set("data", mesh);
endwith();

ResultFeature plot = pg.create("pt1", "PointData");
plot.set("pointdata", coords)
    .set("coloring", "uniform")
    .set("color", "red");
plot.run();

selectNode(pg);

```

### Comments

The first few lines of the method set up a solver step object `step`, which is used to extract the extended mesh information. The extended mesh information, which contains information on the higher-order nodes, is extracted in the line

```
XmeshInfo xmi = step.xmeshInfo();
```

The lines

```

XmeshInfoNodes mynodes = xmi.nodes();
double[][] coords = mynodes.gCoords();
int[] coordsize = matrixSize(coords);

```

access and store the finite element node coordinates in a 2-by-`coordsize` (2D) or 3-by-`coordsize` (3D) array.

The following code segments set up a mesh dataset and an associated mesh plot. The last section uses the low-level `PointData` plot type to visualize the finite element nodes. For more information on this plot type, see “Points in 3D” on page 156.

## Accessing System Matrices and Vectors

---

You can gain low-level access to the finite element system matrices and vectors by adding nodes of the types `Assemble` and `Input Matrix` under a `Study` node.

The example below shows how to set up and solve a 2D electrostatics problem on the unit square  $[0,1]$ -by- $[0,1]$ . After the original problem is solved, the load vector is modified at a user-defined coordinate. The code searches for the degree of freedom closest to the target user-defined coordinate and modifies the load vector to a user-defined value. The physical interpretation of the modified load is that of an added volume charge.

To run the example code below, first use the Model Wizard to create a blank model. Then, add a new method and paste the example code below. Finally, run the method. You can try changing the variable values in the Initializations section at the beginning of the code and run again.

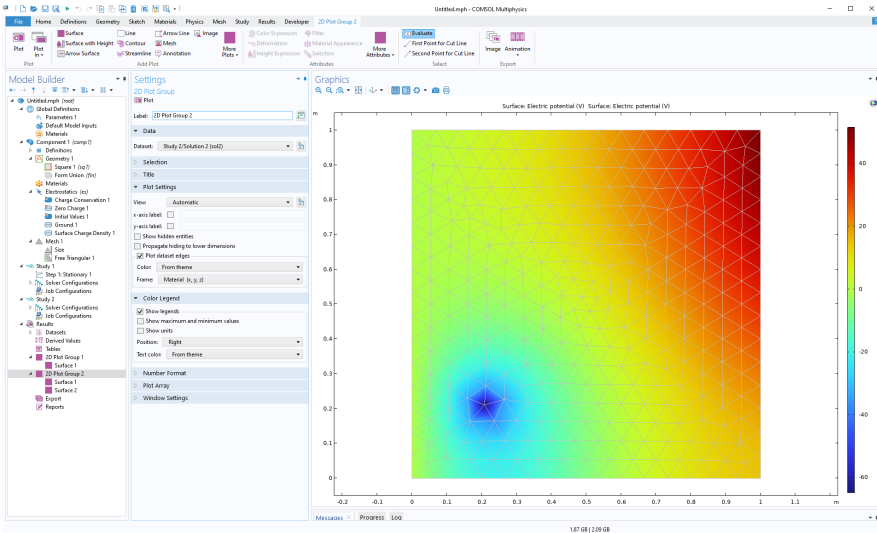

```
// Initializations
double x_load = 0.2; // Target x-coordinate for load
double y_load = 0.2; // Target y-coordinate for load
double load = 1e-9; // Load, volume charge
double dist = 10.0; // Distance to (x_load,y_load) from degree of freedom
int index = 0; // Index of the degree of freedom closest to (x_load,y_load)

// Clear any previous model.
clearModel(model);

// Create a new model component.
model.modelNode().create("comp1");

// Create the 2D geometry.
model.geom().create("geom1", 2);
model.geom("geom1").feature().create("sq1", "Square");
model.geom("geom1").run();

// Create the mesh.
model.mesh().create("mesh1", "geom1");
model.mesh("mesh1").feature().create("fre1", "FreeTri");
model.mesh("mesh1").run();

// Setup the electrostatics physics problem.
model.physics().create("es", "Electrostatics", "geom1");
model.physics("es").feature().create("gnd1", "Ground", 1);
model.physics("es").feature("gnd1").selection().set(new int[]{1});
```

```

model.physics("es").feature().create("sfcd1", "SurfaceChargeDensity", 1);
model.physics("es").feature("sfcd1").selection().set(new int[]{4});
// Add a varying distributed charge density along the rightmost boundary.
model.physics("es").feature("sfcd1").set("rhoqs", "1e-9*y");
model.component("comp1").physics("es").feature("ccn1").set("epsilon_r_mat",
"userdef");
model.component("comp1").physics("es").feature("ccn1").set("epsilon_r", "1");
// Change to 1st order shape functions, to keep things simple.
model.component("comp1").physics("es").prop("ShapeProperty").
set("order_electricpotential", 1);

// Create and run the study.
model.study().create("std1");
model.study("std1").feature().create("stat1", "Stationary");
model.study("std1").run();

// Create a 2D plot group with a surface plot for the original problem.
model.result().create("pg1", 2);
model.result("pg1").set("data", "dset1");
model.result("pg1").feature().create("surf1", "Surface");

selectNode(model.result("pg1")); // Set focus on the plot node.

// Create a reusable solver feature variable.
SolverFeature solft;

model.study().create("std2"); // Create a Study 2 node.
model.sol().create("sol2"); // Create a dataset Solution 2.
// Create a Solver configurations node under Study 2
model.sol("sol2").study("std2");

model.sol("sol2").create("st1", "StudyStep"); // Create a Compile Equations node.
solft = model.sol("sol2").feature("st1"); // Assign solver step to variable
solver.
solft.set("study", "std2");

model.sol("sol2").create("v1", "Variables"); // Create a Dependent Variables
node.
solft = model.sol("sol2").feature("v1");

model.sol("sol2").attach("std2");

model.sol("sol2").create("a1", "Assemble"); // Add an Assemble node.
solft = model.sol("sol2").feature("a1");
// Now define which system matrices should be output (Non-Eliminated Output).
// L=Load vector, K=Stiffness matrix, M=Constraint vector, N=Constraint Jacobian
// For more information see the Programming Reference Manual.
solft.set("L", "on");
solft.set("K", "on");
solft.set("M", "on");
solft.set("N", "on");

//Create a Stationary Solver 2 node: Study 2>Solver Configurations>Solution 2.
model.sol("sol2").create("s2", "Stationary");
// Create an Input Matrix node under Stationary Solver 2.
solft = model.sol("sol2").feature("s2").create("im1", "InputMatrix");

```

```

// Define which system matrices should be input.
solft.set("L", "on");
solft.set("K", "on");
solft.set("M", "on");
solft.set("N", "on");

// Find the degree of freedom coordinate closest to the target coordinate.
solft = model.sol("sol2").feature("v1");
XmeshInfo xmi = solft.xmeshInfo();
XmeshInfoDofs mydofs = xmi.dofs();
double[][] coords = mydofs.gCoords();
int[] coordsize = matrixSize(coords);
double new_dist = dist;
for (int k = 0; k < coordsize[1]; k++) {
    new_dist = Math.sqrt((coords[0][k]-x_load)*(coords[0][k]-x_load)+
        (coords[1][k]-y_load)*(coords[1][k]-y_load));
    if (new_dist < dist) {
        index = k;
        dist = new_dist;
    }
}

// Run the solver sequence up to and including the Assemble node.
model.sol("sol2").runFromTo("st1", "a1");

// Extract system matrices and vectors.
solft = model.sol("sol2").feature("a1");

// K
int KM = solft.getM("K");
int KN = solft.getN("K");
int KNnz = solft.getNnz("K");
int[] Ki = solft.getSparseMatrixRow("K");
int[] Kj = solft.getSparseMatrixCol("K");
double[] Kv = solft.getSparseMatrixVal("K");
// For more information, see the Programming Reference Manual.

// L
double[] Lv = solft.getVector("L");

// N
int NM = solft.getM("N");
int NN = solft.getN("N");
int NNnz = solft.getNnz("N");
int[] Ni = solft.getSparseMatrixRow("N");
int[] Nj = solft.getSparseMatrixCol("N");
double[] Nv = solft.getSparseMatrixVal("N");

// M
double[] Mv = solft.getVector("M");

// Modify the load
Lv[index] = load;

// Put the system matrices and vectors back in again.
solft = model.sol("sol2").feature("s2").feature("im1");

```

```

// K
solft.createSparseMatrix("K", KM, KN, KNnz, true);
solft.addSparseMatrixVal("K", Ki, Kj, Kv);

// L
solft.createVector("L", Lv.length, true);
solft.setVector("L", Lv);

// N
solft.createSparseMatrix("N", NM, NN, NNnz, true);
solft.addSparseMatrixVal("N", Ni, Nj, Nv);

// M
solft.createVector("M", Mv.length, true);
solft.setVector("M", Mv);

// Solve Stationary Solver 2 with the modified system.
model.sol("sol2").runFromTo("s2", "s2");

// Plot the results.
model.result().create("pg2", "PlotGroup2D");
with(model.result("pg2"));
    set("data", "dset2");
endwith();
model.result("pg2").create("surf1", "Surface");
// Plot electric potential and original mesh overlaid with no smoothing.
with(model.result("pg2").feature("surf1"));
    set("resolution", "norefine");
    set("smooth", "none");
endwith();
model.result("pg2").create("surf2", "Surface");
with(model.result("pg2").feature("surf2"));
    set("resolution", "norefine");
    set("coloring", "uniform");
    set("color", "gray");
    set("wireframe", true);
endwith();
model.result("pg2").run();
selectNode(model.result("pg2")); // Set focus on the plot node.

```

### *Comments*

In the previous example, “Accessing Higher-Order Finite Element Nodes” on page 201, the `XmeshInfoNodes` methods are used to access finite element nodes that have the same length as the number of finite element nodes. In this example, the `XmeshInfoDofs` methods are used to access the degrees of freedom vector, which has the same length as the load vector.

Note that only the load vector is modified. The other matrices and vectors are merely extracted and then put back into the system again.

# Data Validation

In the **Settings** window for input fields, the section for **Data Validation** has a subsection **Numerical validation** with settings that allow you to validate user inputs with respect to values. The figure below shows an example of settings for entering a radius.

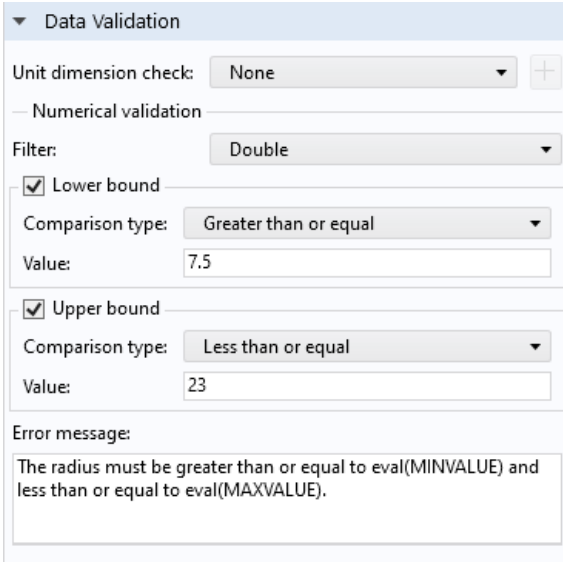

▼ Data Validation

Unit dimension check: None

— Numerical validation

Filter: Double

Lower bound

Comparison type: Greater than or equal

Value: 7.5

Upper bound

Comparison type: Less than or equal

Value: 23

Error message:

The radius must be greater than or equal to eval(MINVALUE) and less than or equal to eval(MAXVALUE).

The **Filter** options, the **Lower bound** and **Upper bound** settings are only visible if the selection in the **Unit dimension check** combo box is set to one of **None**, **Append unit to number** or **Append unit from unit set**.

The **Value** input fields for **Lower bound** and **Upper bound** allow you to use global parameters or scalar declaration variables. Using scalar declaration variables in this field supports the same type of data conversions as when using declaration names as a method input argument in a command sequence. This means that scalar **Integer** and **Double** declaration variable will always work and scalar **String** declarations will work if they can be converted to a **Double**.

Using declaration variable names or global parameters in the **Value** input fields can only be used when **Unit dimension check** is set to **Append unit to number** or **Append unit from unit set**. In that case, the bounds are checked based on the numerical value entered by the user in the input field. In a **Value** input field, you can not use expressions in terms of declared variables, but only a single declaration name. If a parameter exists with the same name as a declaration variable, then the value of the global parameter will be used.



The scope of declaration names used in a **Value** field is limited to the parent form of the input field.

Note that the bounds are updated dynamically as the value of the parameters or declaration variable is changed. This means that several input fields, not actively changed by the user, can fail numerical validation at once caused by a change in another input field which causes the value of a parameter used in a validation bound to change.

The **Error message** text field allows you to write a customized error message to be shown when the input values are out of bounds. The error message text can contain `eval(variable)`, which is also allowed in the title for plot groups in the Model Builder. In addition, the **Tooltip** of the input field allows use of `eval(variable)`. The `variable` can be the name of any global parameter or scalar declaration. If a parameter and a declaration with the same name exists, then the parameter is used. In addition to parameter and declaration names the special strings `MINVALUE` and `MAXVALUE` can be passed to `eval` and will return the value entered as lower bound or upper bound.

When using `eval` for a parameter, it will return the evaluated value of the parameter using the same unit that is used to enter the bounds in the **Value** input field. For a scalar declaration the string value of the declaration is returned which will be true or false for a boolean declaration.

## ACCESS TO OLD VALUE AND NEW VALUE IN EVENT METHODS

You can create a method for an **On data change** event directly from the **Events** section of an input field, as shown in the figure below.

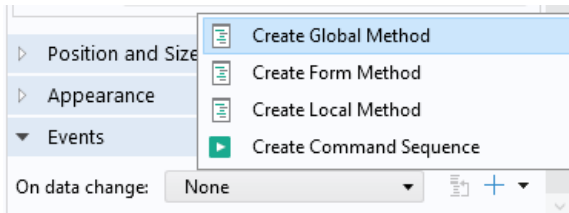

In such a case, the method will automatically get a scalar `String` input argument with the name `newValue`, as shown in the figure below.

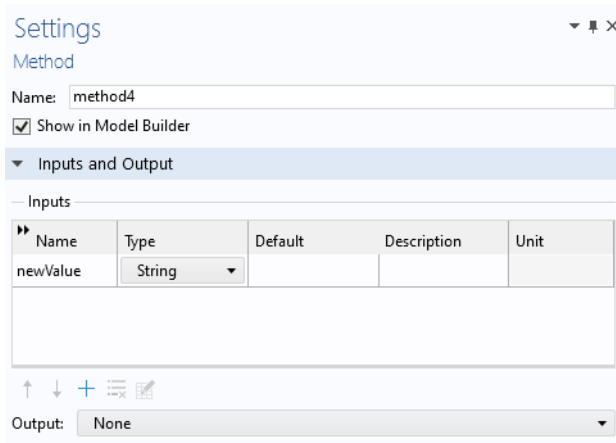

The variable `newValue` will get the new value entered in the input field by the user of the app.

In addition to the new value, you may need to access to the old value entered in the input field, for example, to be able to restore it if your custom data validation fails. For this purpose, you can use the event object and its associated methods which are accessible from methods that are called from events. The event object has the following methods:

```
event.getOldValue()  
event.getNewValue()
```

which return the old and new value, respectively, of the source associated with the form object. The methods return an object called `Value` which is similar to the `DataSource` object returned when you call:

```
app.declaration(<declarationName>)
```

A `DataSource` object has the methods `getBoolean`, `getBooleanArray`, `getBooleanMatrix`, `getDouble`, etc. to allow accessing the value stored in the `DataSource` object no matter what type it has. It also has the corresponding `set` methods to allow setting a value. For more information, see “Data Source” on page 87.

The `Value` object is a read-only version of the `DataSource` object with only the `get` methods.

## ACCESS TO FORMS AND FORM OBJECTS IN EVENT METHODS

For methods that are called from events, you can access the properties `formTag` and `formObjectTag` for the form object that triggered the event. This way, you can access the form object from the event method using the syntax:

```
app.form(<formTag>).formObject(<formObjectTag>)
```

To make it more convenient to access the user control that triggered the event there is also a method

```
event.getUserControl()
```

that returns the form object, menu item, or ribbon item that triggered the event. The event object is additionally available for methods called from command sequences in, for example, menu items and ribbon items. The interface `IPropertyAccess` which has methods for getting and setting values on all user interface controls such as form objects, menu items and so on can then be returned by the `getUserControl` method.

## DATA VALIDATION FROM DIALOG BOXES

A form that is shown as a dialog box can function in two different ways. The first way, which is the default option, works on a copy of the data and stores changes when the user clicks **OK** in the dialog box. The second way is enabled by changing the **Store changes** value of the form, used as a dialog box, from **On request** to **Immediately**, as shown in the figure below.

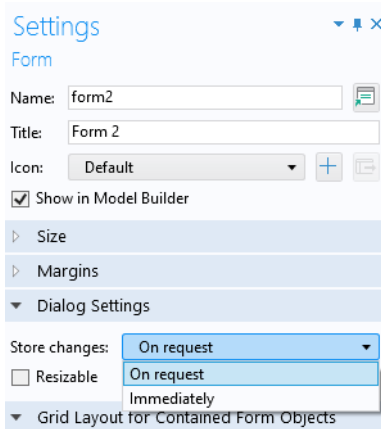

Changes performed in the dialog box will then be stored to the associated source variable or parameter immediately and it will work like a regular form in the main application window.

To accomplish storing of the values when the dialog box is set to work on a copy, corresponding to the first option above, and store the values on request, the **Settings** window for a button object has a check box **Store changes** in the section **Dialog Actions**, as shown in the figure below. When this check box is selected, the values in the dialog box are stored from the copy used by the dialog box to the actual values after the command sequence specified for the button has been run. Part of this command sequence can include a method that performs validation of the data that the user has entered in the dialog box. The figure below shows an example of this scenario, with a method `validate`, for an **OK** button used in a dialog box.

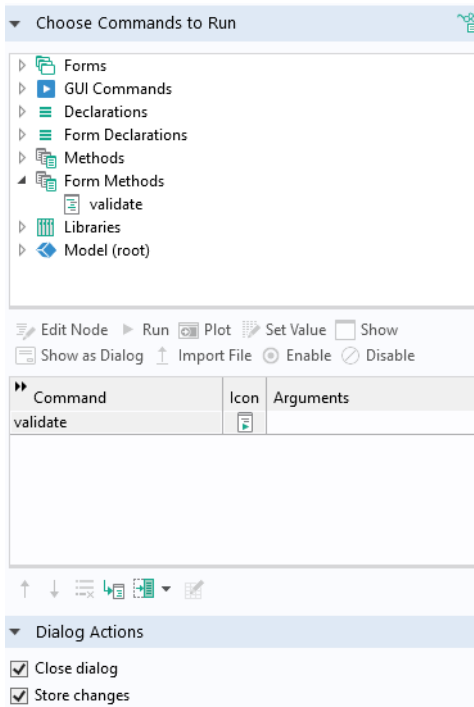

However, this validation approach will not work. This is due to the fact that when the dialog box is set to **Store changes** on request, the values have not yet been stored when the `validate` method runs since dialog actions such as **Store changes** are performed after the command sequence for the button has been run. This means that the `validate` code cannot access the new values to perform a validation on them.

To remedy this, there is an access method that can be used together with form objects such that the value currently entered in them can be used for data

validation before they have been stored in their associated source. The syntax for calling this access method is:

```
app.form(<formTag>).formObject(<formObjectTag>).getValue();
```

This call will return a `Value` object, the same type of object described earlier and used for calls to `event.getOldValue()` and `event.getNewValue()`. With this type of access to the current value in the form object, a data validation can be performed. The following form object types support the `getValue` method.

- Input field
- Toggle Button
- Check box
- Combo box
- File import
- Array input
- Radio button
- Selection input
- Text
- List box
- Table
- Slider
- Knob
- Gauge

If the user has clicked **OK** in a dialog box and the data validation fails, you typically want to show an error dialog box and then leave the dialog box open to allow the user to correct the input fields that failed validation. This not possible to achieve using a direct approach since if the **OK** button is set to have **Store changes** as a **Dialog Action** the storing of the data will always be performed after the command sequence, defined in the **Settings** window of the **OK** button, has been run.

To remedy this, there is a method for programmatically store changes:

```
storeChanges(String name)
```

which will store the changes for a given form, used as a dialog box.

Note that you can call:

```
closeDialog(<dialogTag>)
```

to close a specific dialog box.

When using the technique described above, you can clear the **Store changes** and **Close dialog** check boxes, in the **Dialog Actions** section for the **OK** button and instead

call `storeChanges` and `closeDialog` as part of the flow in the validation method if the validation passes.

Having a way to programmatically store changes also helps with the case where the dialog box contains a button that also performs something when closing the dialog box, for example, a **Compute** button. A validation may then be followed by, for example, a `compute` method. In order to get this `compute` method to work on the new values entered in the dialog box, `storeChanges` can be called after the data validation has been performed but before the `compute` method is called.

## EXAMPLE OF DATA VALIDATION IN FORMS AND DIALOG BOXES

This example illustrates the use of data validation in a form and a dialog box. This app is very simple and does not fulfill any other function than to demonstrate important aspects of data validation. The app consists of a form with one input field that expects the user to type the string `open dialog`, as shown in the figure below

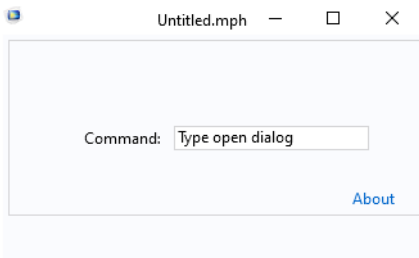

If the user types a different string, then an alert window with a message `Unknown command` is shown:

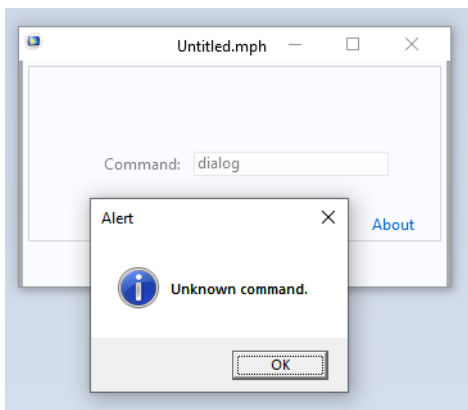

and the string value for the **Command** is reset to the default `Type open dialog`.

If the correct string open dialog is entered, then a dialog box opens, as shown in the figures below.

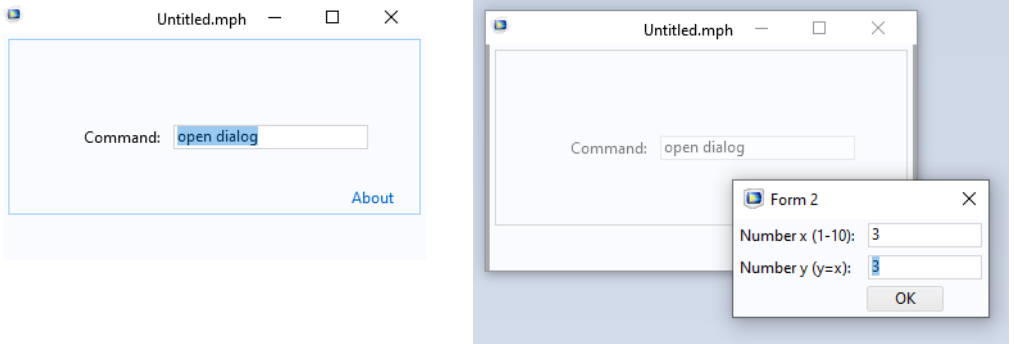

The dialog box expects an integer between 1 and 10, in the first input field. In addition, it expects the value in the second input field to be identical to the value in first input field. If all these criteria is fulfilled, no error message is shown and the app starts from the beginning showing the string Type open dialog in the main form.

If the user enters different values, as shown in the figure below:

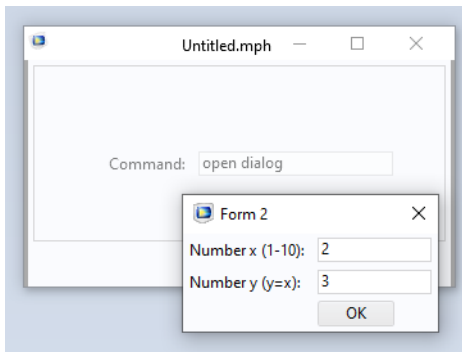

then an error message is shown with the message The value of y must be equal to x.

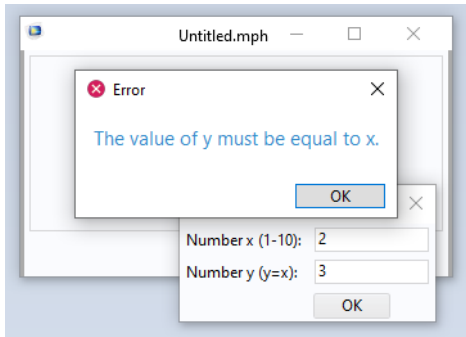

When the user now closes the Error message dialog box, the user gets a new opportunity to enter matching values in the dialog box.

The data validation functionality in this demonstration app is implemented using an `On data change` event for the **Command** input field in the main form `form1`, as shown in the figure below.

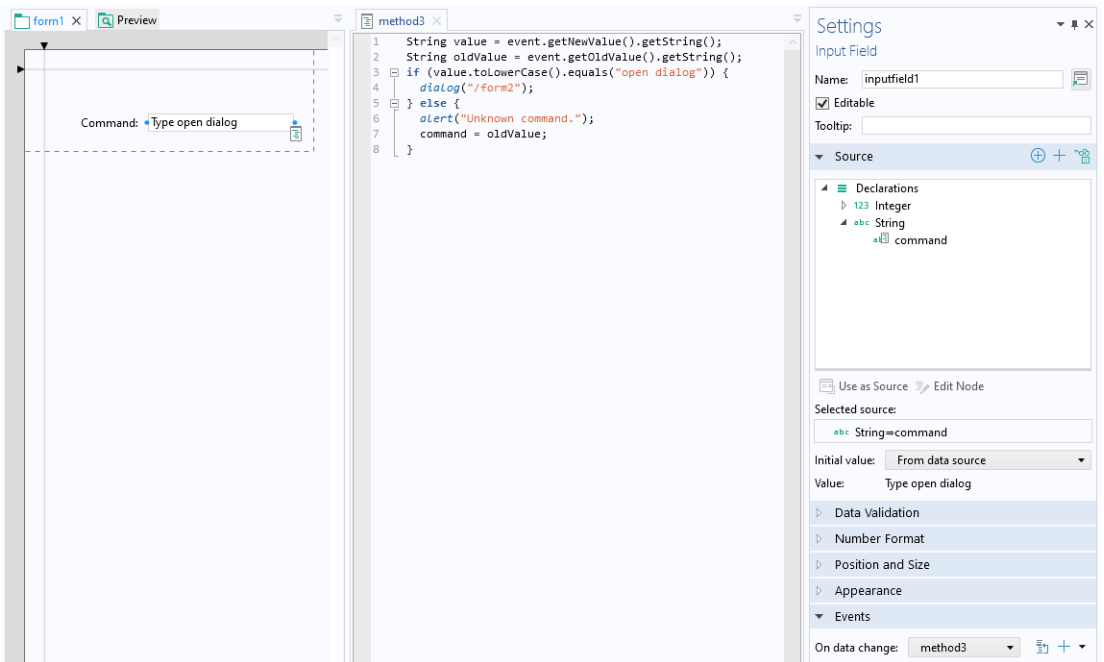



The code in method3 shows the user of `event.getNewValue` and `event.getOldValue`, as shown below:

```
String value = event.getNewValue().getString();
String oldValue = event.getOldValue().getString();
if (value.toLowerCase().equals("open dialog")) {
    dialog("/form2");
} else {
    alert("Unknown command.");
    command = oldValue;
}
}
```

The dialog box `form2` has **Store changes** set to **On request**, as shown in the figure below.

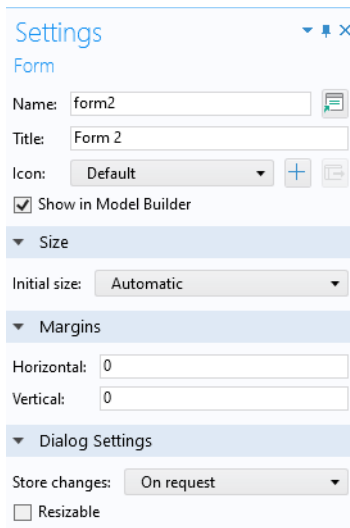

In the dialog box, the value of the variable `x` is validated in the **On data Change** event of the input field with label **Number x (1-10)**: and also when clicking the **OK** button. The `y` value is only validated when clicking the **OK** button. The data validations are implemented using the form object access method `getValue`. The **OK** button makes use of the `storeChanges` method. The figure below shows the

method run for the **On data change** event for the input field with label **Number x (I-10)**:



The corresponding code in method2 is as follows:

```
int valueX =
app.form("form2").formObject("inputfield1").getValue().getInt();
if (valueX < 1 || valueX > 10) {
    error("The value of x must be greater than or equal to 1 and less than or
equal to 10.");
}
```

The **OK** button calls method1 for the **On data Change** event, as shown in the figures below.

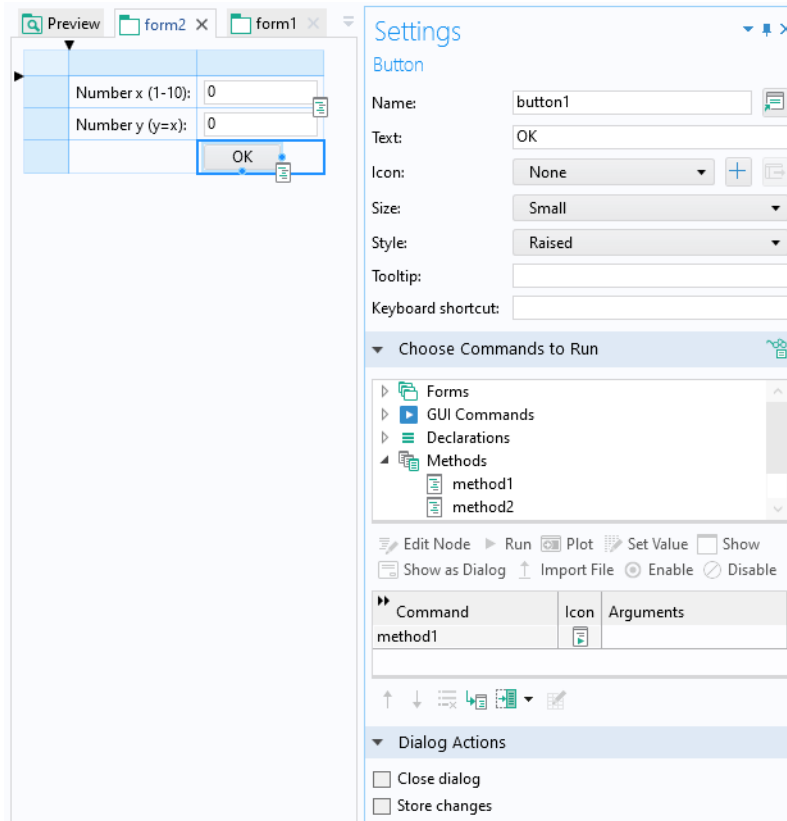

```

1  int valueX = app.form("form2").formObject("inputfield1").getValue().getInt();
2  int valueY = app.form("form2").formObject("inputfield2").getValue().getInt();
3  method2();
4  if (valueX != valueY) {
5      error("The value of y must be equal to x.");
6  } else {
7      storeChanges("/form2");
8      closeDialog("/form2");
9      command = "Type open dialog";
10 }

```

The corresponding code in method1 is as follows:

```

int valueX =
app.form("form2").formObject("inputfield1").getValue().getInt();

```

```
int valueY =
app.form("form2").formObject("inputfield2").getValue().getInt();
method2();
if (valueX != valueY) {
    error("The value of y must be equal to x.");
} else {
    storeChanges("/form2");
    closeDialog("/form2");
    command = "Type open dialog";
}
```

## Using Selections in Add-Ins

---

In order to use selections in the Model Builder from an add-in, you leave the source settings empty when using a selection input form object at the time the add-in is created. Then you use a method to create an explicit selection in the current model and link it to the selection input object of the add-in.

The figure below shows a simple add-in **Boundary Selections** used to demonstrate this functionality. It contains a form with a selection input object and a button. When the add-in is in focus, the user can click on one or more boundaries in the

graphics window to create the selection. Clicking the button triggers an Alert with a dialog box where the selected boundaries are listed.

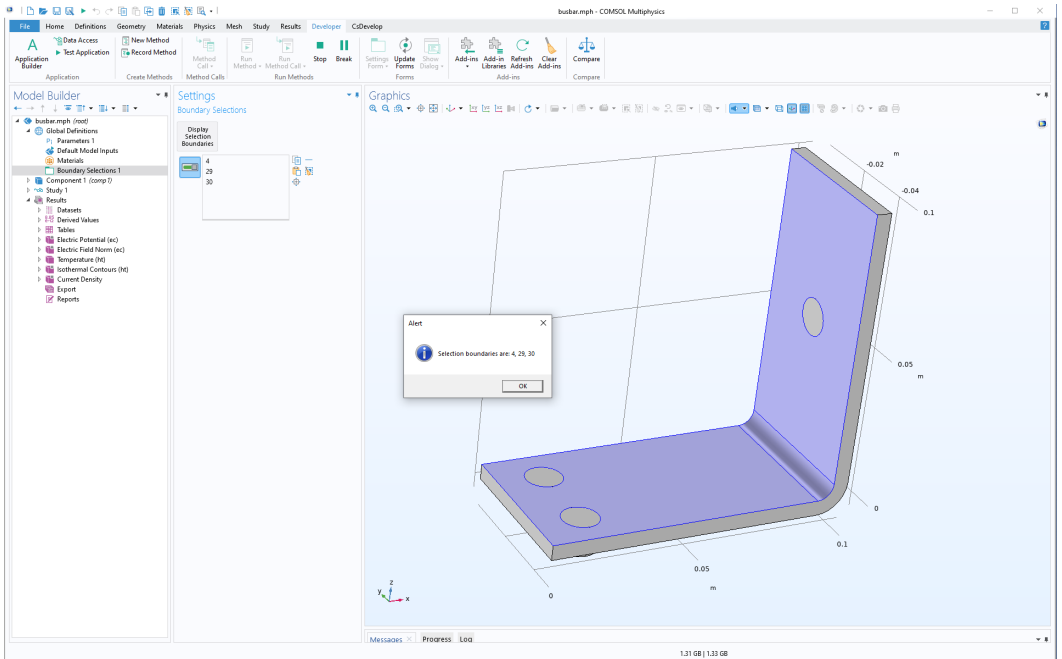

The figure below shows the form of the add-in as it appears when in use in a model:

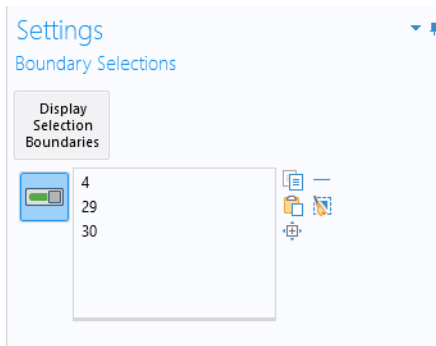

When the add-in **Settings** form is added to a model, an **On load** event is triggered that runs a method `createSelection`. The **Settings** form is shown in the figure below:

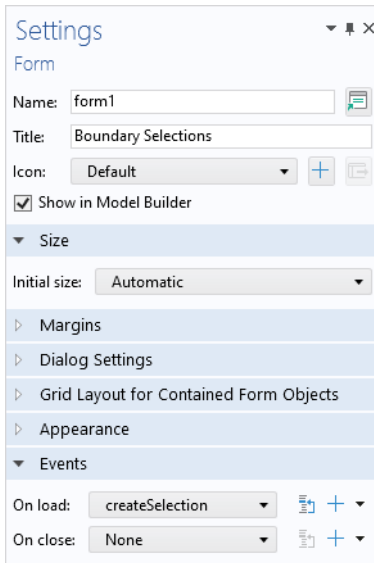

The code for the method `createSelection` is listed below:

```
// Create explicit selection in the model.
if (model.selection().index(selectionTag) < 0) {
    SelectionFeature selection = model.selection().create(selectionTag,
"Explicit");
    selection.geom(2);
    selectioninput1.set("source", selection);
}
// Activate the selection whenever the settings form is selected
selectioninput1.set("active", true);
```

The variable `selectionTag` stores a unique identifier for the Model Builder **Explicit** selection feature. This string needs to be different enough not to

accidentally collide with the user's selection features, used for other purposes, in the Model Builder. The figure below shows the declaration of this String variable.

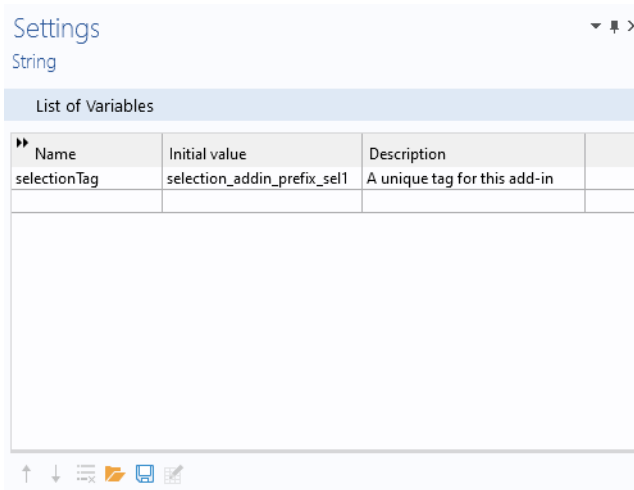

In addition, a shortcut `selectioninput1` is used for the selection input object, as shown in the figure below.

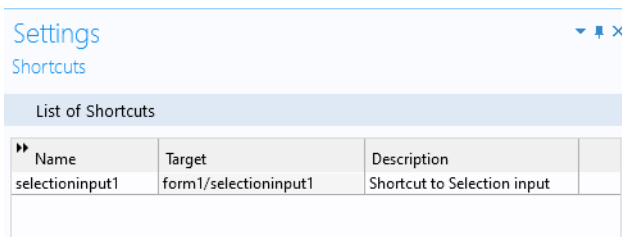

The figure below shows the **Settings** window for the **Selection Input** form object `selectioninput1`. Note the empty selection of the **Source** and **Graphics to Use When Active**. These settings are set by the method `createSelection`.

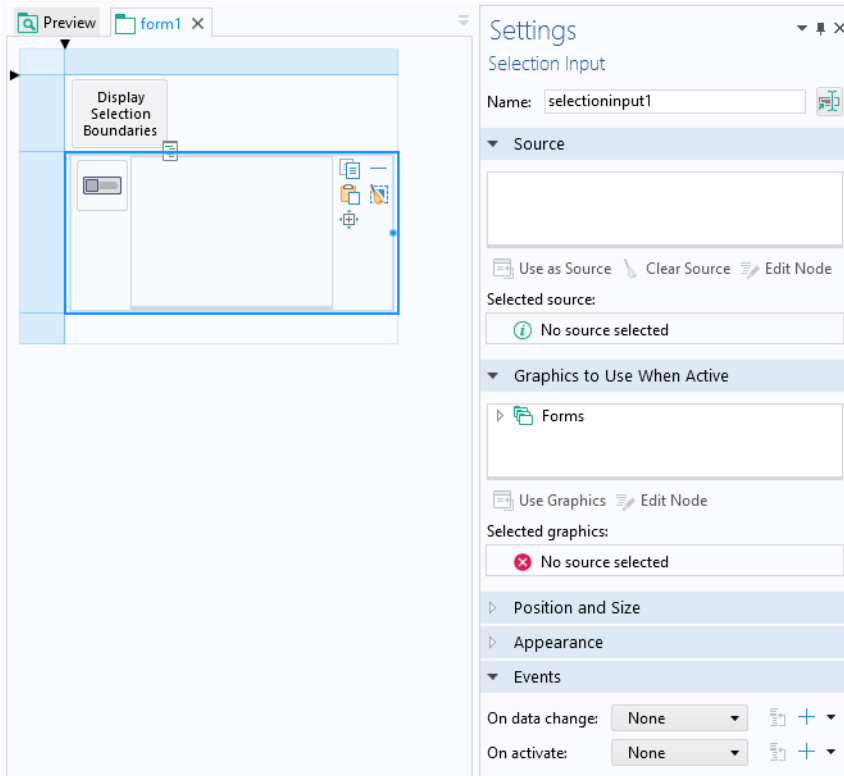



The figure below shows the **Settings** window for the **Button** form object button1.

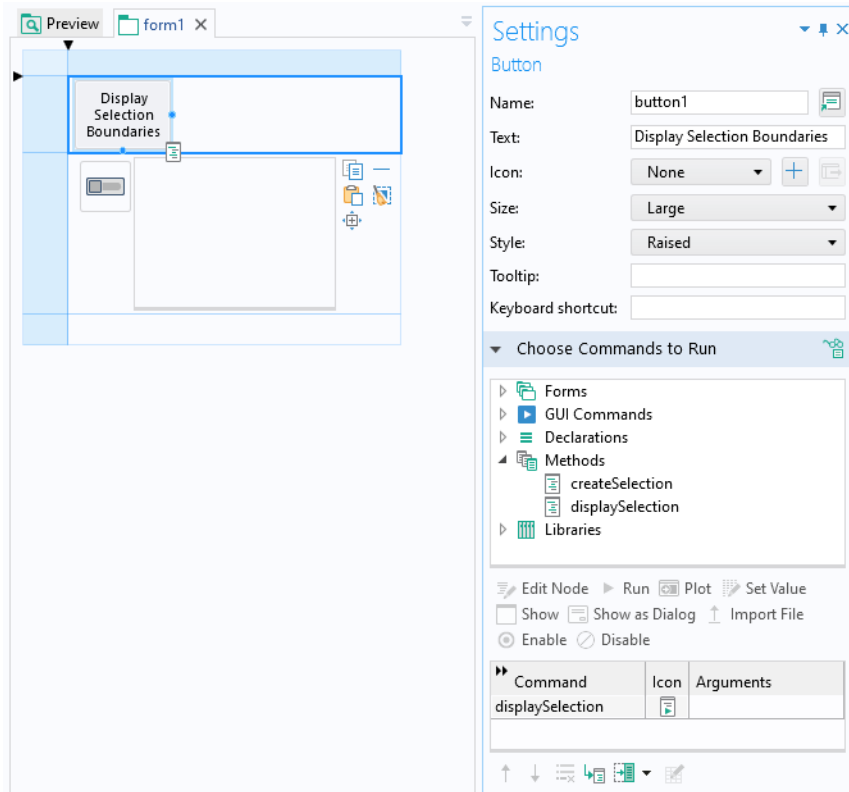

When this button is clicked, a method `displaySelection` is run. The code for this method is shown below.

```
SelectionFeature selection = model.selection(selectionTag);
alert("Selection boundaries are: "+concat(", ",
toString(selection.entities())));
```

For your own add-in, you can replace this code with any number of actions that accepts an explicit selection as an input. For example, you can add the following lines of code to the end of the method `displaySelection` in order to add a variable `a`, local to this explicit selection, having the value 5.

```
model.component("comp1").variable().create("var1");
model.component("comp1").variable("var1").selection().geom("geom1", 2);
model.component("comp1").variable("var1").set("a", "5");
model.component("comp1").variable("var1").selection().named(selectionTag);
```

## Using Built-In Methods from an External Java Library

---

When developing an external Java® library to be used in the Application Builder, it is possible to call the built-in methods from the external library. In order to do so, the `com.comsol.api` JAR-file needs to be added to the project build path, and the classes that call the methods need to extend the `ApplicationLanguageBase` class. The following steps explain how to create a simple example JAR library when using the Eclipse® integrated development environment:

- 1 Start Eclipse®.
- 2 Create a new Java® project. Enter `JavaLibDemo` as the project name and click **Next**.
- 3 Go to the **Libraries** tab and click **Add External JARs**. Add the JAR-file `com.comsol.api_1.0.0.jar` from the `plugins` directory under the COMSOL Multiphysics installation directory; for example  
`C:\Program Files\COMSOL\COMSOL60\Multiphysics\plugins`
- 4 Click **Finish**.
- 5 Right-click the `src` folder in your **Eclipse** project and select **New... Package**. Enter `demo` as the package name and click **Finish**.
- 6 Right-click the `demo` package in your **Eclipse** project and select **New... Class**. Enter `Hello` as the class name.
- 7 Click on **Superclass > Browse...** and select `ApplicationLanguageBase`. Click **OK** and **Finish**.
- 8 In the editor window for the `Hello` class, add the following method and save the file:

```
public static void hello() {  
    alert("Hello!");  
}
```
- 9 Right-click the `JavaLibDemo` project and select **Export... > Java > JAR file**. Select the export destination JAR-file and click **Finish**.
- 10 Start COMSOL Multiphysics and create a **Blank Model**.
- 11 In the Application Builder, under the application tree, right-click **Libraries** and select **External Java Library**. In the **Settings** window, click **Browse...** and select the JAR-file previously exported from Eclipse®.
- 12 In the Application Builder, add a form, button, and method for the button.
- 13 In the Method Editor for the method, add the following code:

```
Hello.hello();
```
- 14 Click **Test Application** and click the button in the application to verify that the `alert` method is invoked.

## Measuring the Java Heap Space Memory

---

Software components that are based on Java®, such as certain parts of COMSOL Multiphysics, are predefined to use only a limited amount of memory. This limit, the Java® heap space, is specified during startup. Note that the Java® heap space only affects certain parts of the software and not, for example, meshing or solvers. By default, COMSOL Multiphysics allocates 2 GB of Java® heap space memory. See the *Reference Manual* for information about increasing the available heap space memory.

In a method, you can measure the amount of heap space memory currently in use. For example, while debugging, you can add the following code:

```
Runtime runtime = java.lang.Runtime.getRuntime();
runtime.gc();
debugLog("Used memory (MB): "+
(runtime.totalMemory()-runtime.freeMemory())/(1024*1024));
```

The first line adds a request to run the Java® garbage collector.

In order to monitor the memory usage in an application, you can replace `debugLog` with `message`.

## Time-Limited and Hardware-Locked Applications

---

By writing a few lines of code, you can make your application expire after a set date and lock the application to specific hardware.



The example MPH-file used in this section is available in the Application Gallery at <https://www.comsol.com/model/70151>

### PASSWORD PROTECTION

The settings of an application can in principle be read from the file system by a user, including method code. By making your application password protected for editing, the method code will no longer be readable. This setting is available from the root node in either the model tree or the application tree, as shown in the

figure below.

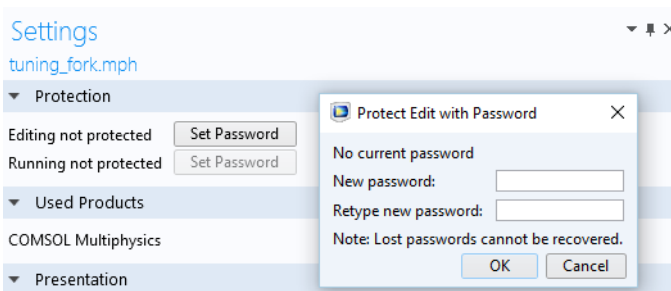

Before implementing a time limit or hardware lock, as described below, make sure your application is password protected. Password protection for running the application is not required for this purpose.

## TIME-LIMITED APPLICATION

To have an application expire after a specific date, create a method as follows:

```
java.text.SimpleDateFormat f = new java.text.SimpleDateFormat("yyyy-MM-dd");
//java.text.SimpleDateFormat f = new java.text.SimpleDateFormat("MM/dd/yyyy");

ok = false;
try {
    java.util.Date d = f.parse(timeoutDate);
    long currentTime = timeStamp();
    long timeoutTime = d.getTime()+24*60*60*1000; // To allow running until the end
        of the day
    if (currentTime < timeoutTime) {
        ok = true;
    }
}
catch (java.text.ParseException e) {
    debugLog("Failed to parse timeout date "+timeoutDate);
    debugLog(e.getMessage());
}
```

In this method, you need to decide on a date format. Two format examples are shown and you can uncomment the line corresponding to the format you would like to use. For more details on available formats, see the Java® documentation for

SimpleDateFormat. This method has one string input argument, `timeoutDate`, and one Boolean output argument, `ok`, as shown below.

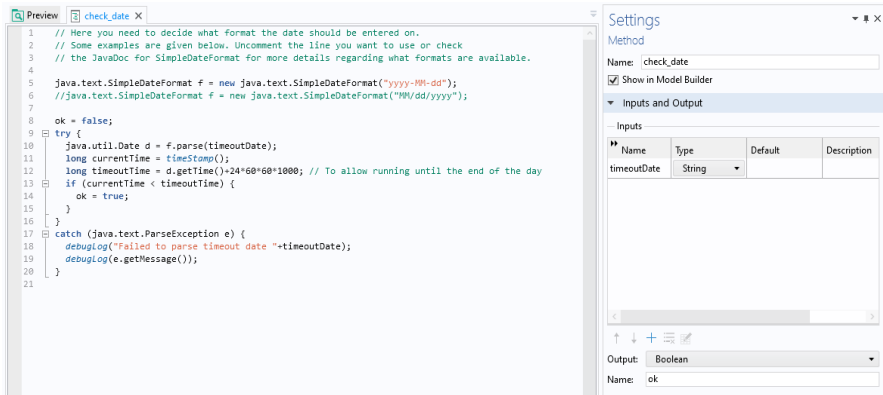

The expiration date is defined as a string variable, `trial_date`, in **Declarations>String**, as shown below.

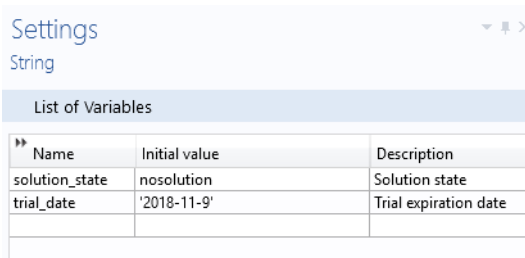

## HARDWARE-LOCKED APPLICATION

To lock an application to the MAC address of a specific network card on a computer, create a method as follows:

```

ok = false;
try {
    java.util.List < java.net.NetworkInterface > nis =
java.util.Collections.list(java.net.NetworkInterface.getNetworkInterfaces());
    for (java.net.NetworkInterface ni : nis) {
        StringBuilder macString = new StringBuilder();
        byte[] macBytes = ni.getHardwareAddress();
        if (macBytes != null && macBytes.length > 0) {
            for (byte b : macBytes) {
                if (macString.length() > 0) {
                    macString.append(":");
                }
                macString.append(String.format("%02x", b));
            }
        }
    }
}

```



```

    exit();
}

if (!check_date(trial_date)) {
    alert("The trial for this application has expired "+trial_date, "COMSOL");
    exit();
}

```

The figure below shows this method in the Method Editor.

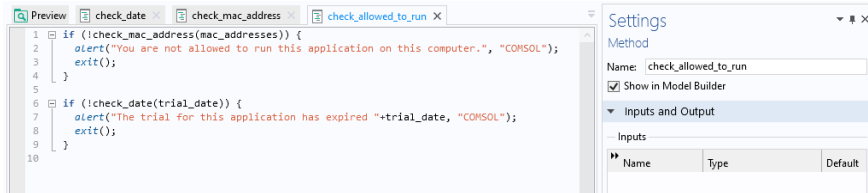

You can call this type of method at startup of the application, for example, as an On load event for the main form of the application. In the Tuning Fork example application, available in the Application Library of COMSOL Multiphysics, there is a method `p_init_application` that is run as an On load event for the main form. In this case, the method `p_init_application` can be edited as follows:

```

check_allowed_to_run();

if (model.sol("sol1").isEmpty()) {
    solution_state = "nosolution";
}
else {
    solution_state = "solutionexists";
}

zoomExtents("graphics1");

```

Notice the call to the method `check_allowed_to_run` in the first line. The figure below shows this method in the Method Editor.

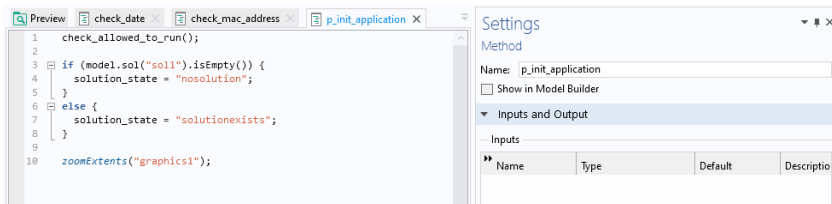

The method `p_init_application` is then called as an **On load** event. This is specified in the **Settings** window of the main form, as shown in the figure below.

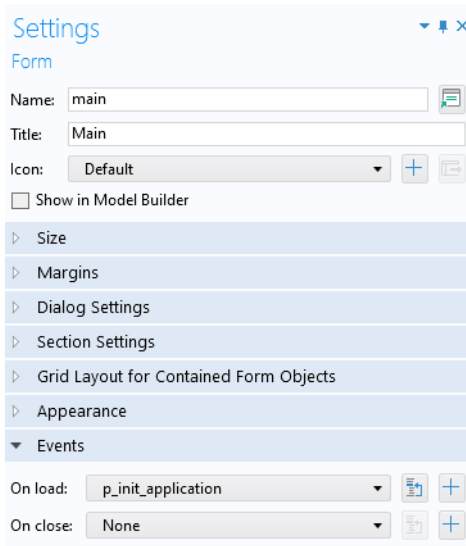



# Index

---

- 1D array *12, 32, 139*
- 2D array *13, 32, 139*
- A**
  - accessing *204*
  - add-in *24, 151, 220*
    - selections *220*
  - alert *115, 121*
  - anisotropic diffusion coefficient *34*
  - Annotation Data plot type *164*
  - Application Builder *55*
  - Application Builder Reference Manual *127*
  - application example
    - tubular reactor *113*
  - application object *7, 26, 55, 95*
    - app variable *57*
    - classes *57*
  - application tree *55*
  - array *12*
    - methods *139*
  - array 1D
    - object *87*
  - array 2D
    - object *87*
  - array input object *65*
  - Arrow Data plot type *162, 163*
  - assignments *8*
  - auto complete *19*
  - automatic solver sequence *47*
  - axisymmetric property *29*
- B**
  - backslash *12*
  - backspace *12*
  - basic data type *29*
  - big endian *187*
  - binary file
    - processing *187*
    - reading *186*
    - writing *185*
  - Blank Model *29*
  - boolean
    - data type *8, 29*
  - Boolean variable *8*
    - conversion *137*
  - bound *208*
  - boundary condition *41*
  - built-in method library *95*
  - button
    - object *66*
- C**
  - C libraries
    - external *126*
  - card stack object *66*
  - carriage return *12*
  - catch *18*
  - C-code
    - linking *126*
  - char
    - data type *8*
  - character
    - data type *8*
  - character stream *180*
  - characters
    - special *179*
  - check box object *67*
  - choice list *58, 89, 118*
    - methods *89*
    - object *87*
  - classes
    - application object *57*
  - code completion *19*
  - code generation *19*
  - collection methods *148*

- color 60
  - of user interface component 59
- combo box object 67
- Compact History 53
- Compile Equations node 45
- computation time 136
  - last 135
- Compute 46
- COMSOL Desktop 51
- COMSOL Help Desk 53
- COMSOL Multiphysics 7, 26
- COMSOL Multiphysics Programming
  - Reference Manual 201
- confirm 11, 115, 121
- contour plot 48
- contour plot data 182
- control flow statements 16
- conversion
  - between data types 9
  - methods 137
- coordinate information 192, 193
- Copy as Code to Clipboard 30
- creating
  - feature node 38, 42
  - model object 28, 51
- CSV-file 165, 172
- curve
  - interpolation 181
  - parameterization 188
- cut point
  - dataset 34, 96
- D** data display object 68
- Data Source
  - class 58, 87
- data types
  - primitive 8
- data validation 208
  - dialog box 211, 214
  - new value 210
  - old value 210
- dataset 48, 154
- DataSource object 210
- date and time methods 134
- debug
  - methods 126
- Debug Log window 126
- declaration 208
  - type 54
- Declarations 12, 14, 56
- deformation plot 34
- degrees of freedom 201
- Dependent Variables node 45
- description 18
  - parameter 18, 35
  - variable 18
- Developer tab 153
- Dialog Actions 212
- dialog box 114
  - data validation 211, 214
- diffusion coefficient
  - anisotropic 34
- dimension
  - spatial 29
- disable form object 59, 63, 64, 65, 118
- Display Name
  - for choice list 118
- double 9
  - data type 8, 29
  - variable conversion 137
- double quotation mark 11
- E** edge
  - parameterization 188
- Editor Tools window 35
- Electric Currents 50
- element
  - order 201
  - size 33, 39
- elementary math functions 15

- email
  - class 110
  - methods 110
  - preferences 112
- email attachment
  - export 110
  - report 110
  - table 110
- embedded model 51
- enable form object 57, 59, 63, 65, 118
- endian 187
- equation
  - object 69
- error dialog box 18
- Error message 209
- eval 209
- events 91, 211
- example code 95, 153
- Excel® file 50, 104, 165, 170, 173
- exception
  - handling 18
- exit 125
  - application 126
- expiration date for application 227
- explicit selection 220
- export
  - email attachment 110
- external C libraries 126
- external Java® library 226
- F** face
  - parameterization 190
- feature node
  - creating 38, 42
  - removing 39, 42
- file
  - methods 100
  - name 104
  - open 107
  - reading 165
  - writing to 165
- File Declaration 168
- file import 168
- file import object 69
- file open
  - system method 107
- file scheme
  - syntax 100, 168
- Filter 208
- finite element
  - accessing 201
  - system matrix 203
  - vector 203
- floating point number 8
- for loop 17, 64, 94
- form
  - class 58, 62
  - declarations 15
  - list methods 93
- form collection 70
- form feed 12
- form method 24
- form object 69
  - class 58, 64
  - list methods 93
  - types 65
- Fully Coupled node 46
- G** general properties 59
- generating code 19
- Geometry node 38
- geometry object 38, 39
  - names 193
- get 29, 30
- global method 24
- global parameter 35
- graphics
  - object 71, 114
  - view 119, 122
- grid dataset 153

- GUI command
  - methods *125*
- GUI related methods *114*
- H** hardware lock *227*
- heap space *227*
- Heat Transfer in Solids *40, 51*
- higher-order element nodes *201*
- history
  - model *52*
- HTML
  - report *122*
- hyperlink object *72*
- I** if-else statement *16*
- image object *72*
- import
  - file *168*
- information card stack object *73*
- information node *136*
- inherit
  - color *60*
- input field *208*
- input field object *74*
- integer
  - data type *8, 29*
  - variable conversion *137*
- interpolation curve *181, 188*
- interpolation function *188*
- Introduction to Application Builder *7, 19, 23, 24, 55, 90, 100, 136, 165*
- Introduction to COMSOL Multiphysics
  - 23, 26*
- isosurface *153*
- item
  - class *58*
  - list methods *93*
  - menu *86*
  - object *86*
  - ribbon *86*
  - toolbar *86*
- iterative solver *45*
- iterator class and method *42*
- J** jagged arrays *12*
- Java
  - Documentation, model object class structure *53*
  - math library *15*
  - programming language *7, 8, 95*
  - syntax *9*
  - unary and binary operators *9*
- Java®
  - character stream *180*
  - classes for read/write *179*
  - external library *226*
  - heap space *227*
- K** keyboard shortcut
  - Ctrl+Space *19*
- knob object *81*
- L** legend *33, 34*
- license
  - check out *126*
  - method *97*
- lighting *160*
- Line Data plot type *157*
- line object *76*
- list box object *76*
- literals *8*
- little endian *187*
- load vector *207*
- loading
  - model *51, 96*
- local method *24*
- locking application to hardware *227*
- log object *77*
- looplevel property *49*
- Lower bound *208*
- M** MAC address *227*

- main application class 57, 61
- main user interface component classes
  - 58
- Main Window
  - class 58, 61
  - node 58
- material
  - link 34
  - tag 90
- Materials node 42
- math functions 15
- maximum value 49
- menu
  - item 86
- mesh
  - information and statistics 200
- mesh element size 33, 39
- Mesh node 39
- message log object 77, 117
- message method 121
- method 7, 95
  - form 24
  - get 30
  - global 24
  - local 24
  - name 25
- Method class 93
- Method Editor 95
  - using 7, 19
- method name 25
- Microsoft® Word® format 122
- model 51
  - loading 51, 96
  - saving 51, 96
- Model Builder 26
- model component 29
- model data access 23
- model history 52, 156
  - recording 53
  - turning off 156
- Model Java-file 52
- Model M-file 52
- model object 7, 26, 42, 55, 95
  - class structure 53
  - tag 26
- model tree 26
  - node 41, 42
- model utility methods 52, 95
- Model Wizard 29, 51
- models, working with multiple 51
- MPH file 51, 95, 125
- multiphysics 50
- Multiphysics node 50
- multiple models 51

**N**

- name
  - form 55, 57
  - form object 55, 57
  - in application object 57
  - method 25
  - scoping 27
  - shortcut 14, 55
  - user interface component 55, 57
- network card 227
- new value
  - data validation 92, 210
- newline 11, 12
- node
  - finite element 201
- nonlinear solver 46
- normal
  - surface 160, 161
- numerical
  - Derived Values 49
- Numerical validation 208

**O**

- old value
  - data validation 92, 210
- On data change event 92, 209

- operating system
  - methods *107*
- operators *37*
  - Java *9*
  - model object *37*
- OS commands *107*
- P** parameter *18, 34, 35, 49*
  - method *17, 24*
  - real and imaginary part *36*
- parameterization
  - edge *188*
  - face *190*
- parameterized solution *49*
- parsing
  - text file *179*
- physics interface *41, 44*
- play sound *108*
- plot
  - group *34, 121*
  - mesh element nodes *96*
  - point trajectories *96*
  - surface *37, 48*
  - table surface *50*
  - useGraphics *114*
- Plot Group node *48*
- plot type
  - Annotation Data *164*
  - Arrow Data *162, 163*
  - Line Data *157*
  - Point Data *155, 156, 203*
  - Surface Data *158, 159, 160*
  - Tube Data *162*
- Point Data plot type *155, 156, 203*
- point trajectories plot *96*
- precedence, of operators *9, 37*
- primitive data types *8*
- printing
  - graphics *125*
- programming examples *95, 153*
- Programming Reference Manual *26, 47, 95, 96, 196, 201*
- progress *128*
  - dialog box *129, 133*
  - methods *128*
- progress bar object *77, 130, 132, 133*
- properties
  - general *59*
- property and property values *29*
- R** radio button object *78*
- ragged arrays *12, 32*
- reading
  - binary file *186*
  - CSV-file *166*
  - Excel® file *170*
  - file *165*
  - matrix file *174*
  - Microsoft Excel® Workbook file *170*
  - spreadsheet *166*
  - text file *179*
  - text file to string *176*
- real and imaginary part
  - of parameter *36*
- Record Code *21, 46*
- recursion *196*
- recursive loop *196*
- removing
  - feature node *39, 42*
- report *112*
  - email attachment *110*
  - HTML *122*
  - Microsoft® Word® format *122*
- request *116, 121*
- reset
  - model history *52*
- Results node *48*
- results table object *78, 118*
- RGB color *60*
- ribbon item *86*

- S**
  - save application *126*
  - save as *125*
  - saving
    - model *51, 96*
  - scalar
    - object *87*
  - scene light *125*
  - sectionwise
    - format *181, 184*
  - sectionwise format *181*
  - selection
    - explicit *220*
  - selection input
    - object *79, 220*
  - selections *193*
    - add-in *220*
  - set *29*
  - setIndex *29*
  - shortcuts *14, 55*
  - Shortcuts node *14*
  - single quotation mark *11*
  - sleep *136*
  - slider object *80*
  - SMTP *112*
  - solution
    - data *153*
    - data structure *45*
    - parameterized *49*
  - Solution node *45*
  - Solver Configurations node *44*
  - solver sequence *44*
  - spacer object *82*
  - spatial dimension *29*
  - special character *11*
    - Java *52*
  - special characters *179*
  - sphere *153*
  - spreadsheet *166*
    - format *101, 174, 175, 181*
  - Stationary Solver node *45*
  - Stationary study step *44*
  - status bar *128*
  - Store changes, in dialog box *211*
  - stream
    - character *180*
  - String
    - data type *10, 29*
    - methods *147*
  - string variable *49*
    - conversion *138*
    - methods *147*
  - strings
    - comparing *11*
    - concatenating *10*
  - Study node *44*
  - subform object *69*
  - surface
    - parameterization *190*
  - Surface Data plot type *158, 159, 160*
  - surface normal *160, 161*
  - surface plot *37, 48*
  - system matrix
    - accessing *204*
  - system methods *107*
    - OS commands *107*
  - system vector *204*
- T**
  - tab *12*
  - table *50*
    - email attachment *110*
    - object *83, 117*
  - Table node *49*
  - table surface plot *50*
  - tag *57*
    - model object *26*
    - physics interface *41*
  - temporary folder
    - location *173*
  - text file *165*

- reading 179
    - writing 179
  - text label object 84
  - text object 83
  - time 134
  - time-limited application 227
  - title 115
  - toggle button object 84
  - toolbar
    - item 86
    - object 85
  - Tooltip 209
  - transparency 123, 125
  - transparent
    - color 60
  - try and catch 18
  - Tube Data plot type 162
  - type declaration 54
- U**
- unit 36
    - object 85
  - Unit List 58
  - unit set
    - methods 89
    - object 87
  - unit sphere 153
  - Unit System 35
  - Upper bound 208
  - username 107
- V**
- Value input field 208
  - Value object 210
  - variable 24
    - description 18
    - name completion 20
  - video object 85
  - view
    - graphics 119, 122
  - visualization 153
- W**
- web page object 86
- while loop 17
  - with statement 17
  - writing
    - CSV-file 172
    - Excel file 173
    - matrix file 175
    - string to text file 178
    - text file 179
      - to binary file 185
      - to file 165, 173
- Z**
- zoom extents 121, 125