

COMSOL NEWS

A MULTIPHYSICS SIMULATION MAGAZINE

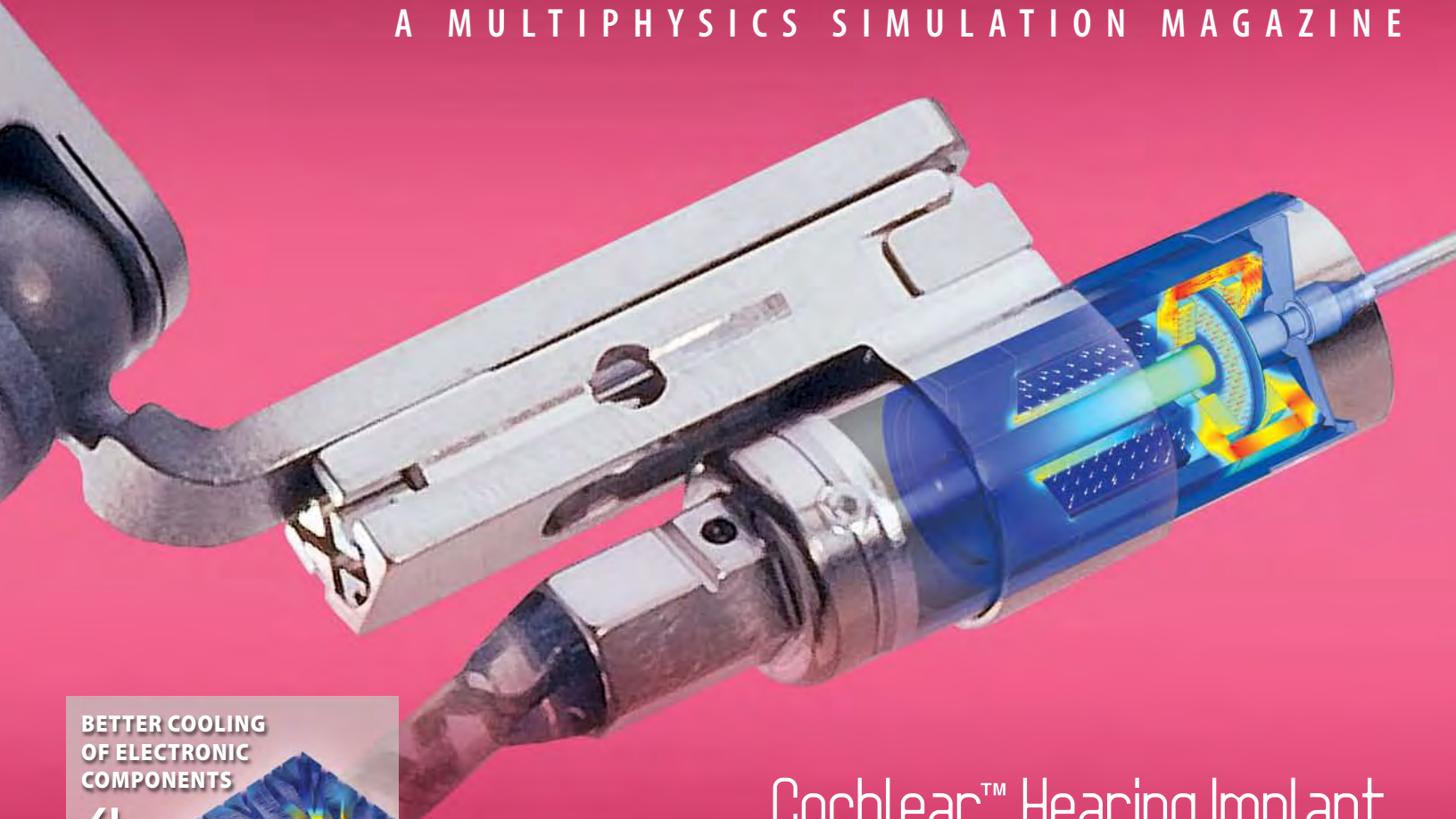

Cochlear™ Hearing Implant Developed from the Ground Up

COVER STORY PAGE 8

**BETTER COOLING
OF ELECTRONIC
COMPONENTS**

4

**OPTIMIZING MEMS
ENERGY HARVESTERS**

12



Multiphysics Simulation Means Breakthroughs and Productivity

This issue of *COMSOL News* showcases how a number of leading scientific, engineering, and medical organizations from a broad range of industries are reaping the benefits of multiphysics simulation in their research and development processes.

Take, for example, engineers at the **Toyota Research Institute of North America** in Ann Arbor, Michigan. Leveraging multiphysics simulation, they came up with a breakthrough design of cold plates for the cooling of power electronic components in hybrid vehicles. With their new solution they gained space and reduced weight in the engine compartment — critical factors for hybrid vehicle efficiency.

Another great example is the MEMS tire energy harvester developed by researchers at **Siemens Corporate Technology** in Munich, Germany. COMSOL Multiphysics helped them boost productivity by enabling them to cut down time-consuming and expensive clean room prototyping runs.

And, we're very delighted to report that simulation is helping to advance medical treatments at the prestigious **Lahey Clinic** in Burlington, Massachusetts. Here, a cross-disciplinary team of neurosurgeons and numerical simulation experts have been working together to improve electrical spinal cord stimulation therapy for the treatment of chronic back pain.

That's just three of the ways that multiphysics simulation is being used by engineers, researchers, and scientists like you to make our future better. You'll find more fascinating reports in this edition of *COMSOL News*. Feel free to contact us with your comments and ideas for future articles as we continue reporting on multiphysics simulation.

Enjoy!

Cordially,
Bernt Nilsson
Sr. VP of Marketing
COMSOL, Inc.

MULTIPHYSICS

- 4 Numerical Simulation-Based Topology Optimization Leads to Better Cooling of Electronic Components in Toyota Hybrid Vehicles
- 8 Simulation-Based Design of New Implantable Hearing Device
- 12 Modeling Optimizes a Piezoelectric Energy Harvester Used in Car Tires
- 15 Optimizing Ultrasound Piezo-Disk Transducers
- 18 Better, Faster Sonar Development with Multiphysics Simulation

ELECTRICAL

- 21 Numerical Modeling of Electrostatic Precipitators
- 24 Current Transformer Design That Combines Finite Element Analysis and Electric Circuit Simulation
- 27 Modeling Scar Effects on Electrical Spinal Cord Stimulation
- 32 Simulation of Magnetic Flux Leakage Inspection
- 34 Surface Plasmon Resonance

HEAT TRANSFER

- 35 Conjugate Heat Transfer
- 38 The Thermal Management of Li-ion Battery Packs

- 40 Cluster Simulation of Refrigeration Systems
- 42 Optimized Heating Process with Uniform Coating
- 44 Simulation-Based Engineering Fosters Innovation and Invention

MECHANICAL

- 48 Shape Changing Lubricants
- 50 Analysis of Subsea Umbilicals and Cables
- 52 Multiphysics Analysis of Pressurized CO₂ Foil Thrust Bearing Characteristics
- 55 Pumping and Injecting from a single Borehole

FLUID FLOW

- 58 The Science of Water Screening
- 61 A Smooth Optical Surface in Minutes

CHEMICALS

- 64 Modeling of Laminar Flow Static Mixers
- 67 Submarines: Corrosion Protection or Enemy Detection?
- 70 Multiphysics Simulations Enable Development of Fast, Cheap MEMS-Based Bacteria Detector

GUEST EDITORIAL

- 72 Mathematical Modeling: An Industrial Perspective

CONTRIBUTORS

ABB AG	Esaote S.p.A	Ruukki Metals Oy	University of Duisburg-Essen/Germany's Technical Centre for Ships and Naval Weapons
Alstom Power Sweden AB	Georg-August-University Intellectual Ventures	Salzgitter Mannesmann Forschung	University of Massachusetts Dartmouth, Sunwell Technologies, Inc.
AltaSim Technologies	JDR Cables	Shell Global Solutions UK	Veryst Engineering LLC, Nordson EFD
Centro Ricerche Fiat	Johnson Screens	Siemens Corporate Technology	Yale University
Cochlear Technology Centre Belgium	Knolls Atomic Power Laboratory	SpaceClaim	Zeeko Ltd
Continuum Blue	Lahey Clinic	Toyota Research Institute of North America	
Desktop Engineering	NASA Tech Briefs		
DuPont Experimental Station	Naval Undersea Warfare Center Division Newport		



ON THE COVER

Simulation of the electromagnetic fields within the balanced armature of a Codacs™ direct acoustic stimulation implant system.

PHOTO COURTESY OF COCHLEAR TECHNOLOGY CENTRE BELGIUM

COMSOL NEWS

We welcome your comments on COMSOL NEWS; contact us at info@comsol.com.

© 2012, all rights reserved. COMSOL NEWS is published by COMSOL, Inc. and its associated companies. COMSOL and COMSOL Multiphysics are registered trademarks of COMSOL AB. Other products or brand names are trademarks or registered trademarks of their respective holders.





VISION

If you can imagine it, we can bring it to life.

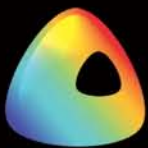

ALTASIM
TECHNOLOGIES
REALIZING TOMORROW'S TECHNOLOGY

Altasim Technologies' team of engineers provide innovative and cost effective solutions for new product development, improved product performance and innovative manufacturing technologies. Our unique S3 Process enables us to harness our engineering technology and advanced computational and multiphysics analysis capabilities. You are able to explore, develop and apply alternative solutions - without the delays and expense associated with traditional testing and evaluation. Contact us today. We'll show you how a great opportunity can become a reality.

(614) 861-7015 | www.altasimtechnologies.com

©2011 Altasim Technologies, Inc. All rights reserved.





Numerical Simulation-Based Topology Optimization Leads to Better Cooling of Electronic Components in Toyota Hybrid Vehicles

One glance under the hood of a modern automobile is all it takes to realize that free space in the engine compartment is a thing of the past.

BY GARY DAGASTINE, CONTRIBUTING EDITOR, TECH BRIEFS MEDIA GROUP

If carmakers could reduce the number, size, and weight of the components in there, better fuel economy would result. A case in point is the design and development of optimized cooling structures, or advanced heat sinks, for thermally regulating the growing number of power electronics components used in the electrical system of Toyota hybrid vehicles.

To save the time and expense associated with analytical design methods and trial-and-error physical prototyping, researchers at the Toyota Research Institute of North America (TRI-NA) in Ann Arbor, MI instead used numerical simulation and multiphysics topology optimization techniques to design, fabricate, and test possible prototypes of a novel heat sink for future hybrid vehicle generations.

One example prototype combines single-phase jet impingement cooling in the plate's center region with integral hierarchical branching cooling channels to cool the periphery. The channels radiate from the device's center where a single jet impinges, and carry liquid coolant across the plate to dissipate heat evenly throughout and with minimal pressure loss.

Numerical simulations enabled Dr. Ercan (Eric) Dede, Principal Scientist in TRI-NA's Electronics Research Depart-



The Toyota Research Institute of North America's topology optimization team includes (from left) Ercan Dede Ph.D., Principal Scientist; Jaewook Lee Ph.D., Researcher; and Tsuyoshi Nomura Ph.D., Sr. Principal Engineer.

ment, and colleagues to produce the optimized branching cooling channel patterns in an automated fashion using advanced simulation tools as opposed to a traditional trial-and-error design approach.

He carried out this work as part of TRI-NA's mission to conduct accelerated advanced research in the areas of energy and environment, safety, and mobility infrastructure. TRI-NA is a division of the Toyota Technical Center, which in turn is part of Toyota Motor Engineering & Manufacturing North America,

overseeing R&D, engineering design and development, and manufacturing activities for Toyota's North American plants.

TRI-NA's Electronics Research Department focuses on two main areas: sensors and actuators, and power electronics. Among its resources are powerful modeling and simulation capabilities and prototype design tools, which enable its staff to develop effective solutions in the compressed timeframes demanded by the highly competitive automotive markets.





Hot Under the Hood

Toyota hybrid vehicles have sophisticated electrical systems in which many power diodes and power semiconductors such as insulated gate bipolar transistors (IGBTs) are used for power conversion and other applications. These components are standard planar silicon devices measuring a few centimeters per side, with high power dissipation.

In these hybrid vehicles, they are mounted on aluminum heat sinks, or cold plates, through which a water/glycol coolant mixture is pumped. In earlier model years, the cold plate design featured a fluid inlet on one side of the plate, outlet on the other side, and in between were arrangements of mostly straight cooling channels through which the coolant flowed. The long channels provided adequate heat transfer but it came at the cost of a significant pressure drop across the plate.

However, the technology roadmap for these power components calls for them to shrink to about half their current size while dissipating the same amount of power, meaning that heat fluxes will have to increase. In addition, although they have a 150 °C maximum operating temperature, typical silicon devices are kept at lower temperatures for greater component reliability. Moreover, the role

of such devices is becoming more important as the electrification of vehicle systems increases.

All of these factors mean that thermal management of these devices will become more difficult than it has been to date.

It might seem reasonable to simply redesign the cold plates so that more cool-

“Toyota decided to look at re-engineering the cold plate with an eye toward achieving optimum heat transfer and negligible additional pressure drop simultaneously.”

ant can be pumped through them. But that would require more pumping power, and with space already at a premium in the engine compartment where the pump is located, moving to a larger, more powerful pump or adding an additional pump is unacceptable.

Instead, Toyota decided to look at re-engineering the cold plate with an eye toward achieving optimum heat transfer and negligible additional pressure

drop simultaneously. If both could be achieved, thermal objectives could be met at no significant increase in system pumping capacity.

Jet Impingement an Incomplete Solution

“Many researchers working on diverse applications have identified jet impingement as an attractive way to cool surfaces,” said Dede. “But while jet impingement performs well with respect heat dissipation close to the jet, it’s less than optimum as you move away from the orifice.”

The reason is that the highest heat transfer occurs close to the jet entrance where the fluid is the coolest and velocity is the highest. As a result, much heat-transfer capability is lost by the time the coolant reaches the exit of the cold plate.

One solution to this problem is to combine jet impingement with a peripheral channel structure to increase the area-average heat transfer. “It’s in your interest to make those channels short to keep pressure drop to a minimum, but short, straight channels aren’t efficient enough for our use,” Dede explained. “Our goal was to come up with a combination jet-impingement/channel-flow-based cold plate with optimally designed branching

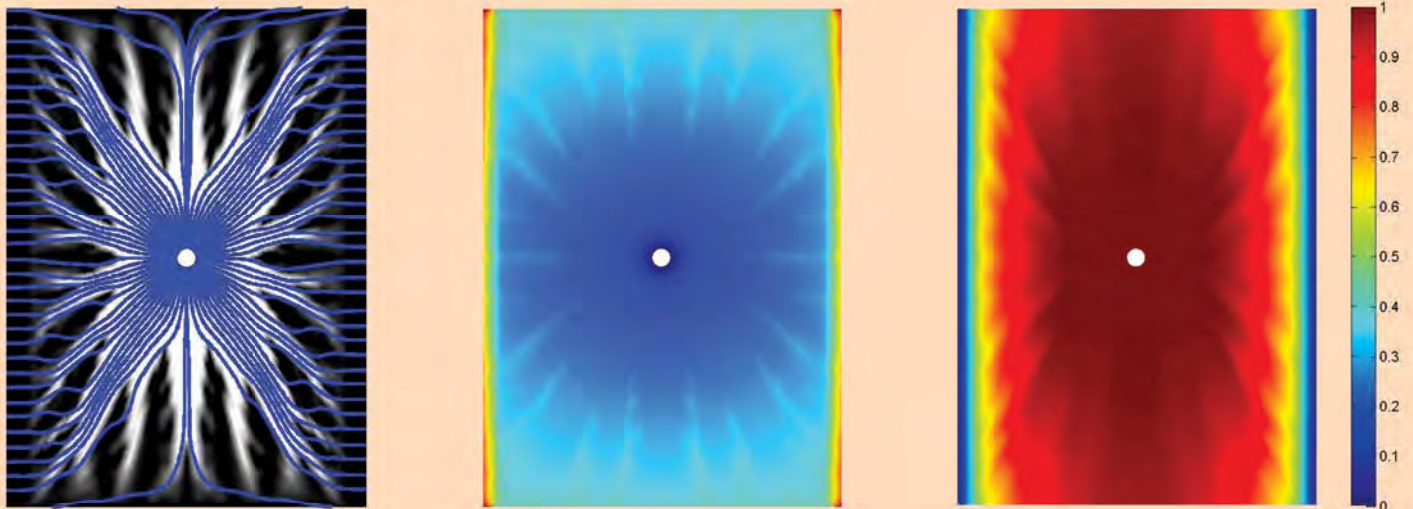

Figure 1. Optimal cooling channel topology with fluid streamlines colored blue (left); normalized temperature contours (center); and normalized pressure contours (right).



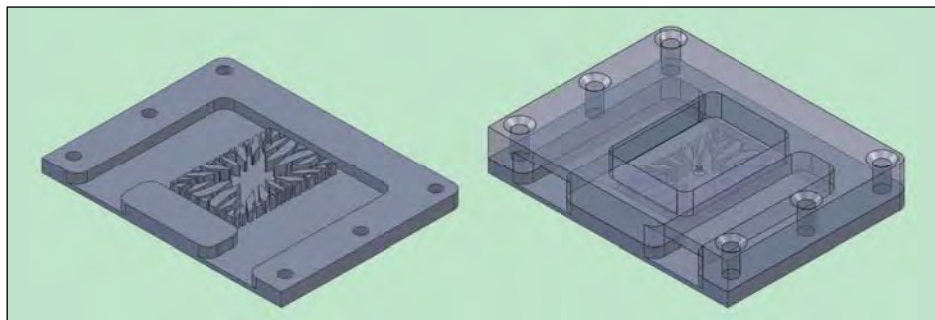

Figure 2. Isometric views of the derived hierarchical microchannel cold plate without a jet plate (left) and with a jet plate shown transparent for clarity (right).

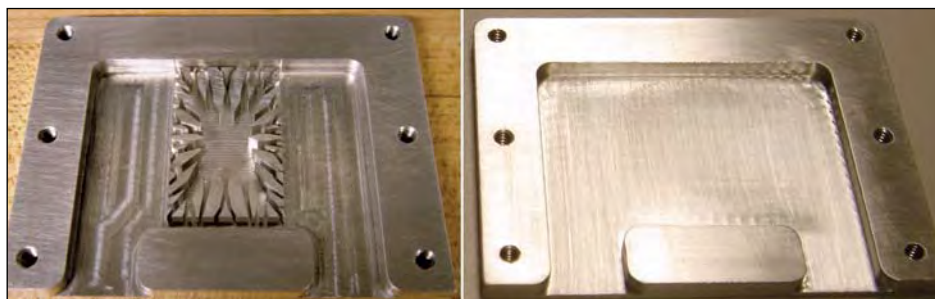

Figure 3. Prototype aluminum cold plates with (left) and without (right) the hierarchical microchannel topology.

channels to uniformly remove the most heat with the least pressure drop.”

The CFD and Heat Transfer Modules of COMSOL Multiphysics software were essential to the numerical simulations at the heart of this work. COMSOL’s LiveLink™ for MATLAB® also enabled Dede to work with the multiphysics simulations in a high-level scripting language as he went about the task of optimizing the cold plate’s topology.

He examined how topology influenced such variables as steady-state convection-diffusion heat transfer and fluid flow. He did this using well-established material interpolation techniques and a Method of Moving Asymptotes (MMA) optimizer, moving back and forth between COMSOL and MATLAB in an iterative fashion to investigate cooling channel layouts. (MMA is a convex-approximation strategy to aid in optimizing physical structures.)

Although the aspect ratio of the channels (i.e. ratio of height to width) is quite important, to simplify the numerical simulations Dede assumed a thin 3D structure and then further “flattened” it. Once an initial channel topology was derived, the height of the

finns that separate the cooling channels could be investigated and incorporated with a separate parametric sizing study. Dede’s group had separately performed such studies so his assumptions were well-informed.

Ultimately, these numeric simulations produced an optimal cooling channel topology with fluid streamlines in branching channels (Figure 1).

Because these channels efficiently distribute coolant throughout the plate and create relatively uniform temperature and pressure distributions that are a function of branching complexity, this fractal-like topology was in turn used to guide the design of a cold plate prototype

(Figure 2). The size of the plate was set to approximately 60 mm × 45 mm with a middle cooling zone covering a 25 mm × 15 mm-sized area to match a specific heat source. The plate’s base substrate thickness was assumed to be 1 mm.

Real-World Performance

“Once we used COMSOL and MATLAB for the topology optimization routine, we then used the final channel concept from it to design and evaluate a prototype using COMSOL’s LiveLink™ for SolidWorks®,” Dede said. “COMSOL has a nice feature that allows you to actively link to computer-aided design tools, and it was easy to import various structures from SolidWorks back into COMSOL to verify pressure drop and heat transfer.

“I think this is really the future of simulation, to be able to link your CAD tool to your simulation tool so that you can streamline the development of fast, accurate design iterations.”

“I think this is really the future of simulation, to be able to link your CAD tool to your simulation tool so that you can streamline the development of fast, accurate design iterations,” Dede added. “It’s not necessarily going to solve all of your problems, but it helps you to quick-

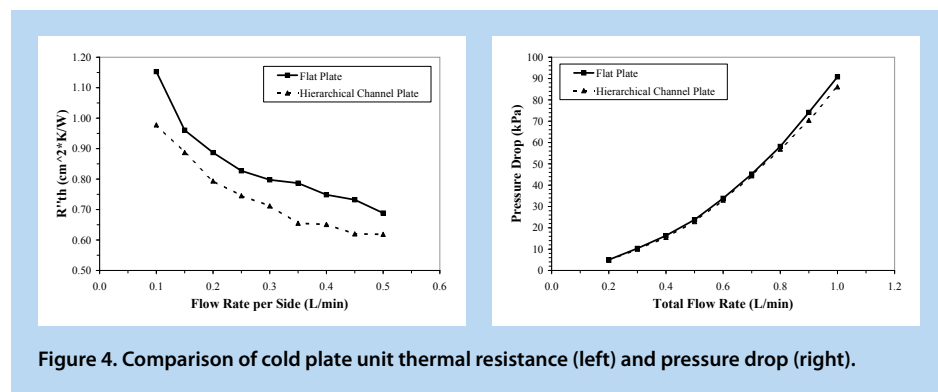

Figure 4. Comparison of cold plate unit thermal resistance (left) and pressure drop (right).





ly establish a reasonable starting point and to progress from there quickly.”

Using the SolidWorks designs, two prototypes were fabricated from aluminum using standard micromachining techniques. Two such prototypes were produced that compared unit thermal resistance and pressure drop in a combined jet/hierarchical microchannel version against a version that utilized jet impingement of a simple flat plate (Figure 3).

The prototypes were then incorporated into a double-sided cooling test set-up to see whether a dual configuration might provide higher-performance cooling in an ultra-compact package size.

On average, the dual-hierarchical microchannel version dissipated 12.8 percent more power than the flat plate version (Figure 4 — left). Indeed, using water as the coolant, it demonstrated very high heat transfer when cooling on both sides of the heat source was accounted for. With regard to pressure drop, both cold plates demonstrated similar results, although the dual-hierarchical version performed slightly better at higher flow rates (Figure 4 — right).

Future Directions

Dede noted that the cold plate concept could be applied to multi-chip packages or even could be used in a multi-pass configuration for a single-chip package for higher-performance cooling (Figure 5).

Along these lines, Dede performed other numerical topology optimization simulations to study the fluid flow of a cold plate inlet manifold comprising a single fluid inlet and six outlets. This manifold

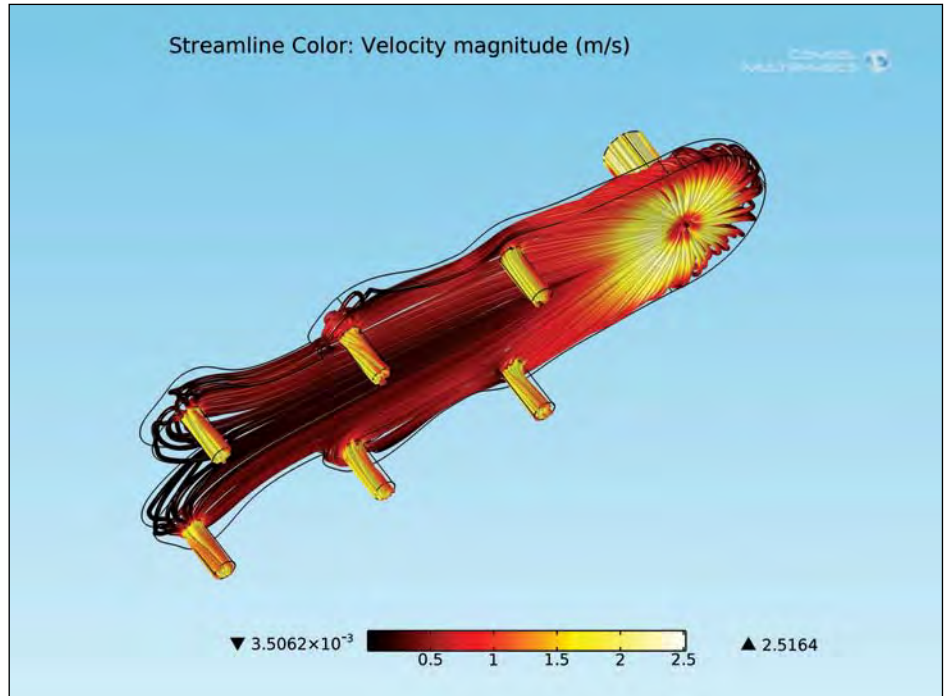

Figure 6. Manifold to feed fluid to multiple multi-pass cooling cells.

could feed fluid to multiple multi-pass cooling cells. In Figure 6, the fluid streamlines are colored with velocity magnitude. The curvy sidewall manifold shape was generated through COMSOL fluid-flow topology optimization studies, where the goal was to minimize the pressure drop across the manifold while balancing the flow rate to each outlet nozzle.

The flow rates across all nozzles are within 7 percent of each other and the pressure drop is about 2 kPa, meaning that the different local sections of the cold plate would receive the same coolant flow. This results in the device temperature distribution across the cold plate being evenly balanced.

“The work we’ve done here is really just the first iteration of this solution,” Dede said. “In the future, we will also look at such things as manifold design to decrease the pumping penalty further. Also, we may be able to optimize the topology of each individual cooling cell so that it works optimally in a 3D configuration.”

And what about even farther down the road? “We can apply these methods to other things, like electromagnetics and thermal stresses, as well. We believe this project is just the beginning for numerical-simulation-based topology optimization,” he said. ■

LEARN MORE

For more information, see the paper “Experimental Investigation of the Thermal Performance of a Manifold Hierarchical Microchannel Cold Plate,” by Toyota’s Ercan M. Dede in the InterPack 2011 Conference Proceedings (the ASME 2011 Pacific Rim Technical Conference & Exposition on Packaging and Integration of Electronic and Photonic Systems).

MATLAB is a registered trademark of The MathWorks, Inc. SolidWorks is a registered trademark of Dassault Systèmes SolidWorks Corp.

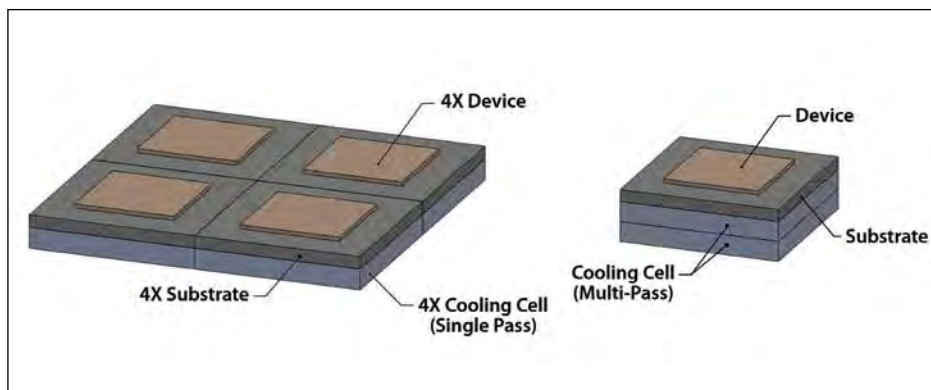

Figure 5. Multi-chip application (left) and multi-pass configuration for single-chip.





Simulation-Based Design of New Implantable Hearing Device

A new hearing solution holds the promise of being able to treat a hearing defect for which currently no good solution exists. Cochlear Ltd. has used COMSOL Multiphysics to develop a unique acoustic cochlear implant from the ground up.

BY PAUL SCHREIER

Hearing loss is not uncommon, and in fact, approximately 17% (36 million) of American adults report some degree of it. Moderate to severe hearing loss can be treated with a hearing aid. Beyond a certain level of hearing loss, a conventional hearing aid no longer provides a solution. For these cases, a hearing implant such as a bone conduction implant or a cochlear implant may be a solution. Cochlear Ltd., headquartered in Australia, has annual sales exceeding AUD 800 million and claims more than three-quarters of the market for such implants.

Over the years, Cochlear Ltd. has helped more than 250,000 people in over 100 countries connect to a world of hearing, and the company is very involved in coming up with even better solutions. In 2011, it invested 13% of

its revenues in R&D. “A recent development,” reports Dr. Patrik Kennes, CAE Engineer at the Cochlear Technology Centre Belgium (CTCB), “is a completely new type of hearing implant, a Direct Acoustic Cochlear Implant (DACI) called Codacs™. It provides mechanical (acoustic) stimulations directly to the cochlea — and it’s a product our company developed from the ground up using COMSOL Multiphysics. While providing a new solution to people who suffer from severe to profound mixed hearing loss, this device fills the gap where a conventional hearing aid isn’t powerful enough. The unit is now in clinical trials, and the outcomes from this feasibility study are encouraging and confirm the design direction and viability of a commercial product.”



Figure 1. Diagram showing the Codacs™ direct acoustic stimulation implant system; below shows the parts that are implanted.

“A Direct Acoustic Cochlear Implant (DACI) called Codacs™ is a product our company developed from the ground up using COMSOL Multiphysics.”





Wireless Implantable Actuator Mimics the Natural Hearing Pathway

“The Codacs system,” explains Dr. Kennes, “starts with a BTE (Behind The Ear) unit that has a similar functionality as the outer ear: picking up the sound (Figure 1). It contains batteries, two microphones for directional hearing, along with some digital signal-processing circuitry. The signal is sent over a wireless link to the actuator (Figure 2), which is implanted in the ear cavity right behind the external auditory canal. That link eliminates the

need to feed a cable through the skin and also provides the power for the implanted unit, which requires no batteries.”

The Codacs actuator is not intended to amplify the sound (as a traditional hearing aid does), but it directly amplifies the pressure waves inside the cochlea. For a person with normal hearing, those pressure waves are generated by vibrations of the stapes footplate. The hair cells inside the cochlea bend as a result of the pressure fluctuations, and generate tiny electrical pulses that are transmitted to the brain by the hearing nerve.

With the Codacs system, a miniature actuator generates amplified pressure waves

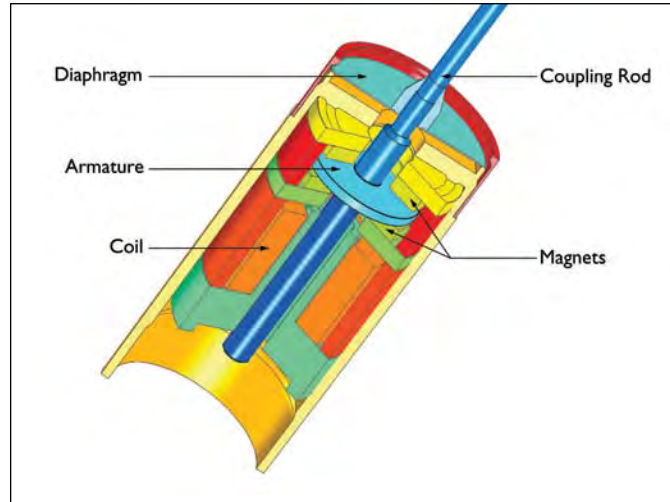

Figure 2. The actuator that is embedded in the ear cavity.

in the cochlear fluid, thus mechanically intensifying the sound energy to compensate for the hearing loss. In order to do this, the artificial incus at the actuator end is connected to a stapes prosthesis that protrudes into the cochlea. Vibrations of the piston-like stapes prosthesis cause pressure variations in the cochlear fluid, in a very similar way as movements of the ossicles are doing.

Actuator Design Challenges

The Codacs actuator is an electromagnetic transducer based on the balanced armature principle (Figure 2). When the armature is at the mid position between

both permanent magnets, it is equally attracted towards both of them and thus no net magnetic force is executed (i.e. balanced position). As soon as the armature moves out of its mid-position, the distance towards both magnets and thus the force exerted by them is no longer equal: the armature is attracted more by the nearest magnet than by the other magnet. This is also referred to as “negative spring stiffness” because it is the opposite of what happens with a normal structural spring: if you deform the spring, it tends to return back

to its original position. For the Codacs actuator, the diaphragm acts as a restoring spring and prevents the armature from sticking to the magnets. A precise balancing of the diaphragm force and magnet force is indispensable for a correct working of the actuator: when the diaphragm stiffness is too low, for example, the air gap collapses and the armature will stick to one of the magnets. Powering the coil modulates the magnetic field, provoking a movement of the armature towards one of both magnets.

According to Dr. Kennes, “We first came up with this concept roughly five years ago and have used COMSOL extensively

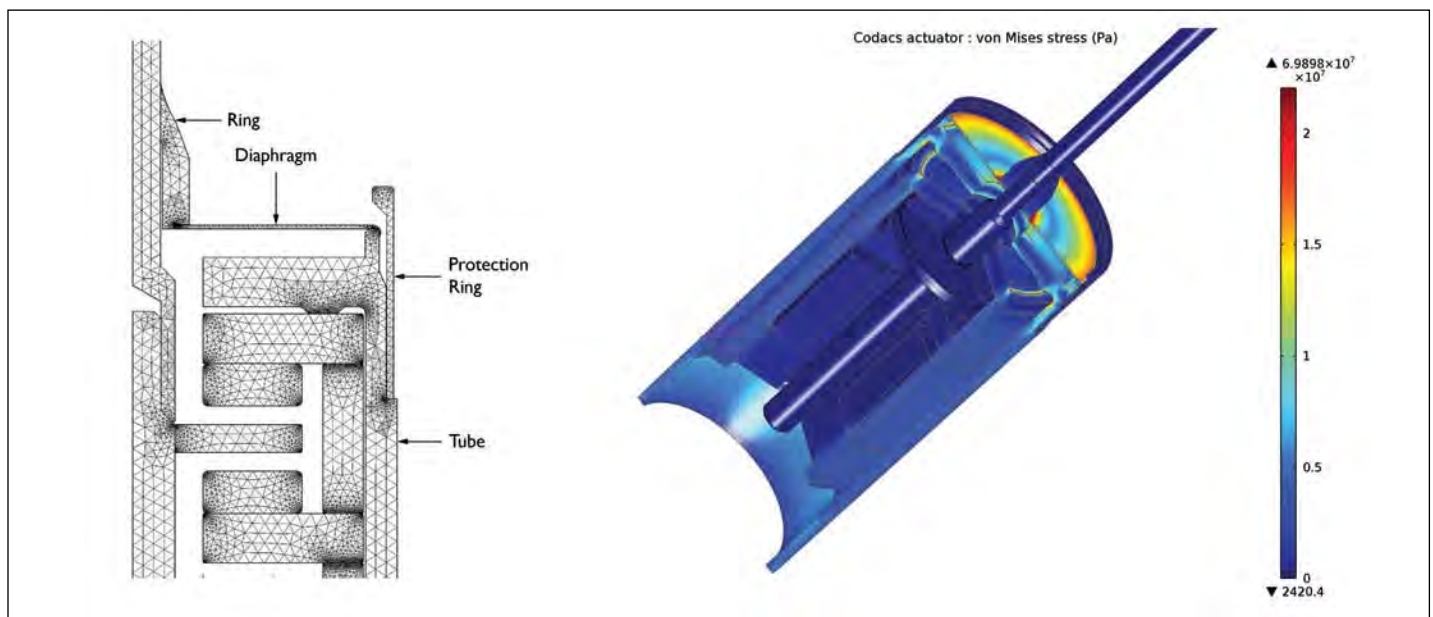

Figure 3. A structural model analyzing von Mises stress helps find the optimum diaphragm thickness.

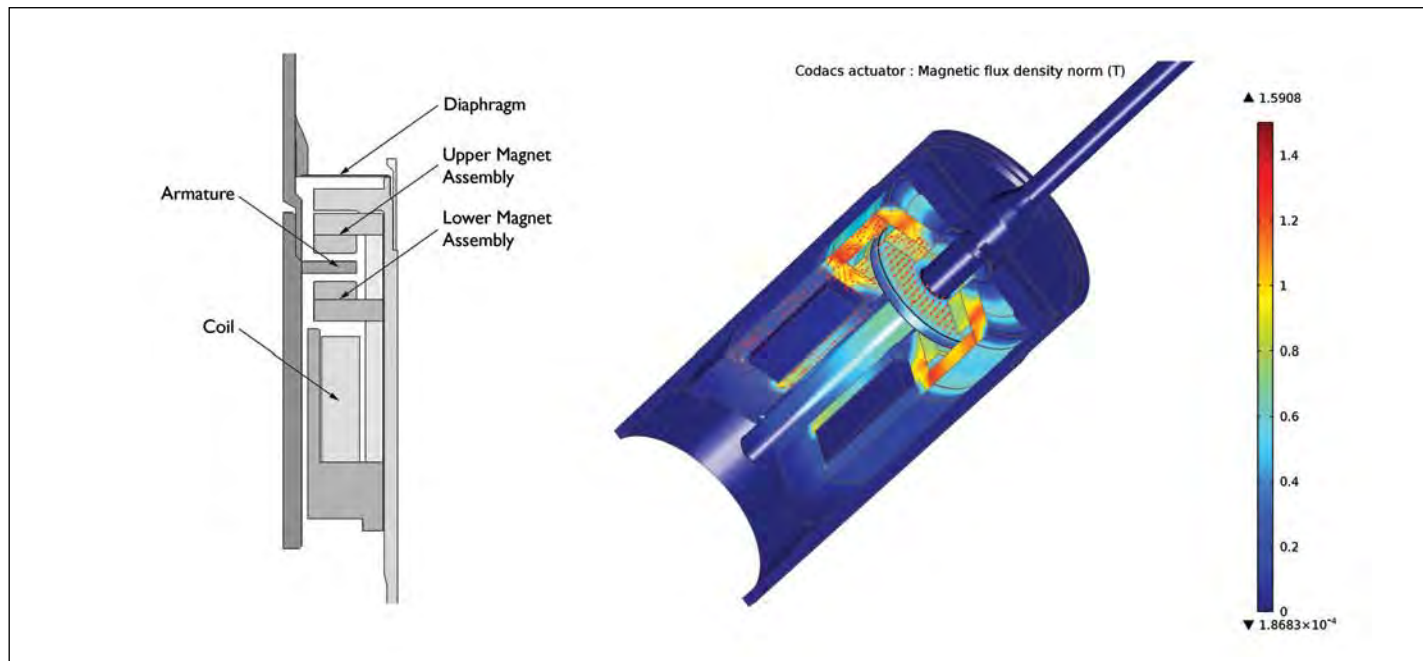

Figure 4. 3D model to study the electromagnetic fields within the balanced armature.

in every stage of the design process. The initial idea was to create a small actuator producing vibrations, but we had no idea of the dimension of the components. A first COMSOL model was thus simply a feasibility study to help us compare various concepts.”

Once the concept was selected, the researchers moved into the prototype definition phase where they worked on the exact size and shape of the parts. The designers had to keep a number of factors in mind; in particular, the maximum allowable size due to the limited space in the

A Critical Component: The Diaphragm

One critical component is the titanium diaphragm that combines multiple functionalities. It serves as a radial bearing for the coupling rod and as a restoring spring for the armature movement. But at the same time, it also must hermetically seal the device and must be biocompatible. Its thickness is a critical tuning parameter because it helps establish the actuator’s spring stiffness. That thickness (actually less than only 50 microns) should not be too thin, making the ac-

ponents was verified. A plot of the von Mises stress (right hand image in Figure 3) shows how the diaphragm is stressed when the rod moves axially (i.e. when the actuator is operating); stress elsewhere is due to the preload on the parts that is applied during the actuator assembly process. For example, the colored ring area in the upper magnet assembly indicates the contact area where the magnet assembly seats against the tube (modeled in COMSOL as contact pair).

Once the diaphragm thickness is fixed, the corresponding mechanical stiffness of the actuator is known. In order to lower the actuator’s overall axial stiffness, the magnetic stiffness of the electromagnetic assembly must be tuned to the correct value. Key parameters here are the magnet strength and air gap size. To optimize the layout of the magnetic circuit, Kennes used COMSOL’s AC/DC Module to calculate the magnetic flux density within the parts (Figure 4). In the plot of the magnetic flux lines, the major flux is due to the permanent magnets (short loop formed by the upper and lower magnet assembly). When the coil is powered, an additional flux is generated (flux in the shaft and the coil assembly). The latter changes the magnetic force on the armature, causing the ac-

“Through COMSOL, we were able to avoid a time-consuming and costly trial-and-error design approach whereby we would have to build many prototypes to determine the appropriate part dimensions.”

mastoid cavity — the diameter had to be < 4 mm with a length < 15 mm. The actuator must provide a frequency characteristic similar to the human ear (resonance frequency near 1 kHz). They also had to keep power consumption in mind, and all the actuator parts in contact with human tissue must be biocompatible or hermetically encapsulated.

tuator unacceptably vulnerable for losing hermeticity. On the other hand, the diaphragm cannot be so thick that it increases actuator stiffness too much. The tradeoff between robustness and stiffness is made by means of a structural mechanics analysis for various thickness values. At this design phase, the material stress within the actuator com-





tuator to move. For the team, it was very convenient to set up a parametric study that defines the armature position and coil current, and calculates the corresponding force on the armature. Resulting data are automatically gathered in a force map that can easily be exported.

An All-in-One Package

What impressed the team greatly was that COMSOL allowed them to do a number of studies — structural, acoustics, electromagnetic, piezoelectric — in one, unified package. “Once we had one model, we didn’t have to start from scratch to set up another that used different physics. We simply added or removed components as needed, changed the physics, and in just a few steps, we had a new case study.

“Through COMSOL,” summarizes Dr. Kennes, “we were able to avoid a time-consuming and costly trial-and-error design approach whereby we would have to build many prototypes to determine the appropriate part dimensions.



About the Researcher

Patrik Kennes joined the Cochlear Technology Centre Belgium as a CAE engineer in January 2007, where he gained initial experience with COMSOL Multiphysics, mainly for structural calculations. Now he also uses that software for electromagnetic, acoustic, piezo and thermal calculations. He previously worked as a research engineer at Tenneco Automotive in the field of continuously controlled electronic suspension systems. He earned a Master of Science and a PhD in Bioscience Engineering at Katholieke Universiteit, Leuven, Belgium.

Even with the approximations made in the model, we were able to tune the device successfully in software. Tolerances in this device are extremely tight, and to get parts for prototypes, they deal with specialist suppliers who have lead times of several weeks. Without

COMSOL, it would take us half a year to run through just five prototypes, thus considerably slowing down the development process.” ■

RESEARCH PAPER

www.comsol.com/papers/2598/

FREE SUBSCRIPTION!

If you do simulation-driven design, you need to sign up today at:
www.deskeng.com/subscribe

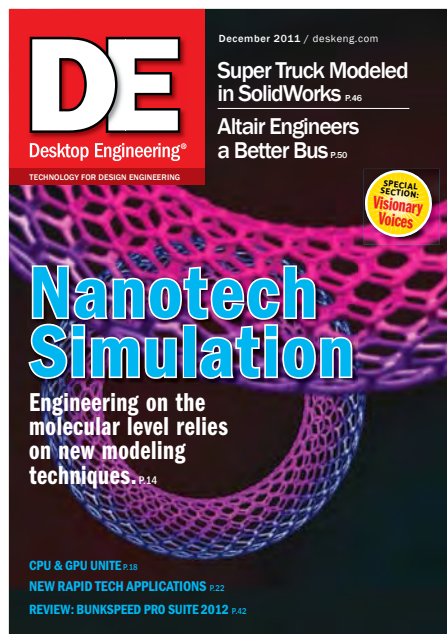



Modeling Optimizes a Piezoelectric Energy Harvester Used in Car Tires

Siemens is using fluid-structure interaction simulation to ensure the cost-effective optimization of a cantilever in a MEMS generator designed to power a tire pressure monitoring system.

BY JENNIFER HAND
CO-AUTHORED BY DR. INGO KUEHNE AND DR. ALEXANDER FREY, SIEMENS AG

The desire to get rid of batteries and power lines motivates a wide range of research. In the quest for systems that are energy autonomous, the concept of energy harvesting attracts much attention. Combine this idea with operation at the micro level and the ‘what if’ scenarios become even more enticing.

“Our ultimate goal is to design the MEMS generator to be as small, light and strong as possible with enough energy to power a system under a range of conditions.”

For researchers at Siemens Corporate Technology in Munich, there was a strong attraction for exploring the potential of an energy harvesting MEMS (Micro Electro-Mechanical System) generator. Dr. Ingo Kuehne explains, “Our remit is broad.

We are looking to develop platform technologies for tomorrow rather than specific products; however, it makes sense to demonstrate the value of our research. Together with our partner Continental AG we decided to focus on an application with clear commercial potential. Our ultimate goal is to design the MEMS generator to be as small, light and strong as possible with enough energy to power a system under a range of conditions.” They chose to design a microgenerator for an innovative Tire Pressure Monitoring System (TPMS) driven by motion.

Because TPMS are traditionally powered by batteries, they tend to be mounted on the wheel rim. With no reliance on a battery, such a system could be placed inside the tire and would be in a position to measure much more than pressure (Figure 1). It could monitor temperature, friction, wear and torque; assist with optimal track-

ing and engine control; and convey all this critical information wirelessly. It would also be maintenance free, low cost and environmentally friendly.

Yet, locating the device within the tire requires that the assembly be extremely robust and able to withstand gravitational acceleration up to 2,500 g. Moreover, in order to avoid tire imbalance it would have to be very light, and in terms of operational life it would need to match that of a tire, a minimum of 8 years.

From Mechanical Stress into Electrical Energy

Mounted to one spot on the inside of a tire, a piezoelectric microgenerator would be able to harvest energy from the compression created each time that particular area of the tire touched the ground. The cantilever was designed to incorporate a thin film of self-polarized piezoelectric ceramic material with a silicon carrier layer, which provides mechanical stability and stores harvested mechanical energy (Figure 2).

The team had settled on a triangular design for the spring-loaded piezoelectric cantilever, as such a shape enables a

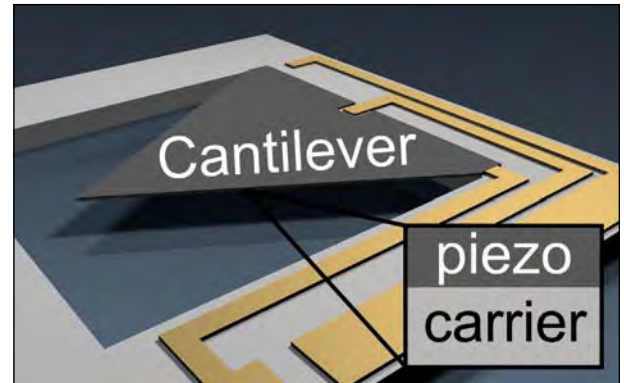

Figure 2. Schematic of the piezoelectric MEMS generator energy harvester. The cantilever is made of two materials and electrical energy is transferred through the circuit from the cantilever.

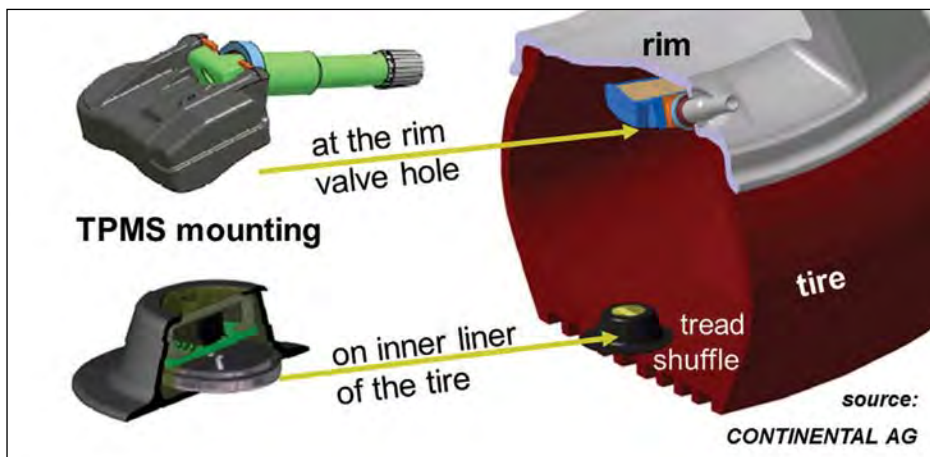

Figure 1. TPMS mounting options — on the rim or on the inner lining of the tire.



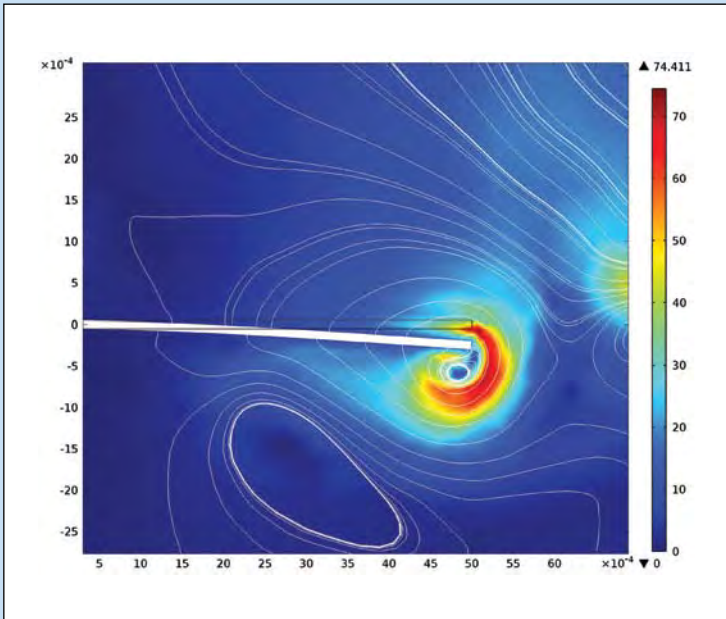

Figure 3. 2D Fluid-Structure Interaction simulation showing the resulting velocity field caused by feeding mechanical cantilever energy into the disordered kinetic energy of the surrounding gas.

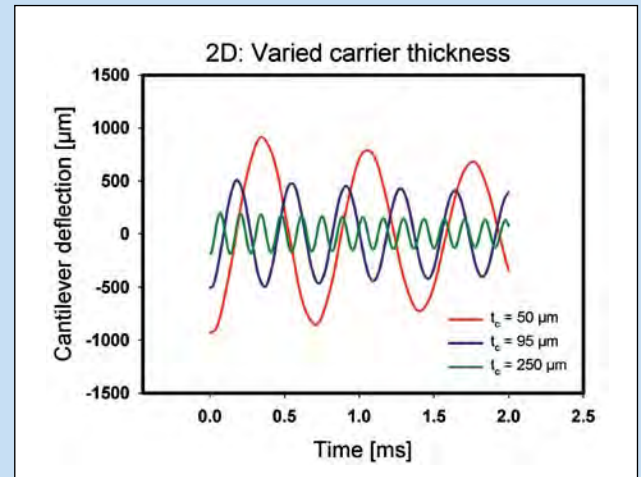
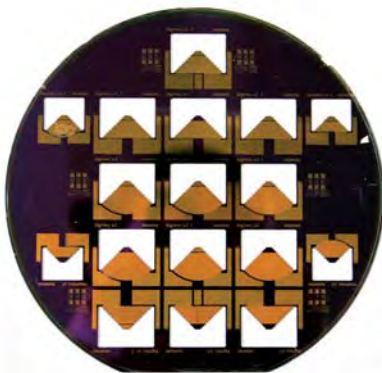

Figure 4. 2D simulations of fluid-structure interaction on a cantilever's deflection at a gas pressure of 1 bar for varied carrier thickness.



One of the wafers used with prototype designs of the MEMS Energy Harvester.

uniform stress distribution in the surface direction. "Typical cantilever designs have substantial mass and are heavy with a concentrated weight at the tip. This is fine for the conventional method of continuously exciting a cantilever at its natural frequency. However, the high dynamic forces we are dealing with prevent us from using this method of excitation," comments Dr. Alexander Frey. "We had to adopt an unconventional approach and avoid mass and its concentration. This in turn gave us a more serious problem because damping becomes much more critical."

The big question for the Siemens team was how to optimize the design of the can-

tilver in order to minimize damping. It appeared that air damping was the dominant effect, and the aerodynamic profile was a critical parameter. While the cantilever area was limited to 100 mm² the layer thicknesses were design parameters that could be freely changed. "We needed to find suitable values for these parameters so that we could ensure that the mechanical oscillation would continue for as long as possible, and transfer as much of the mechanical energy as possible to the electrical domain," comments Dr. Frey. "We really needed a numerical tool to determine the optimal structure and ensure that enough energy was being produced."

Fluid and Structure: An Open Relationship

Identifying the transfer of mechanical energy to the surrounding air as being critical, the team first conducted a

Fluid-Structure Interaction (FSI) analysis of the cantilever. Dr. Kuehne explains, "We started with static simulations and these gave us some initial values. Then, a time-dependent analysis allowed us to see a range of physical effects and understand the impact of the surrounding air on the damping of the cantilever." (Figures 3 and 4)

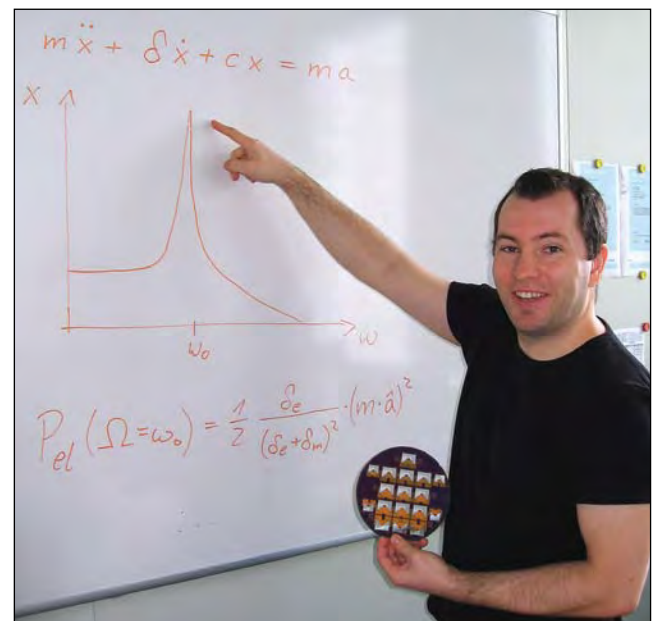

Dr. Ingo Kuehne holding one of the wafers used in the production of the MEMS Energy Harvester prototypes.



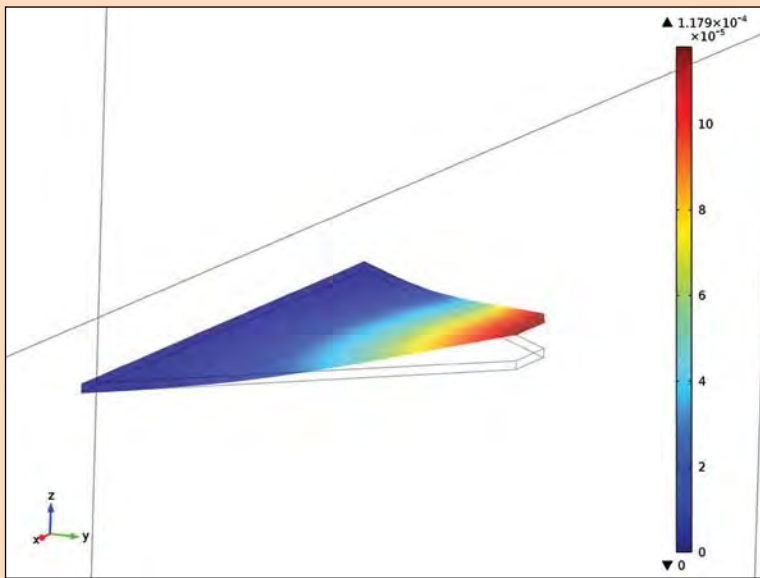

Figure 5. 3D Fluid-Structure Interaction simulation showing the deflection of the triangular cantilever.

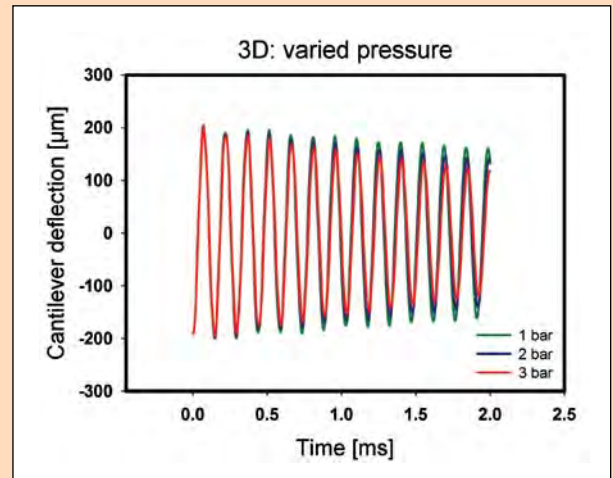

Figure 6. 3D simulations of fluid-structure interaction on a cantilever's deflection as a function of gas pressure with a carrier thickness of 250 μm .

Members of the team went on to conduct a 3D FSI simulation and to consider the cantilever deflection as a function of external pressure and carrier thickness (Figures 5 and 6). They examined the maximum stress required for initial deflection at each thickness where, as Dr. Frey reports, “We confirmed quantitatively that increasing the thickness of the cantilever led to an improvement in the damping behavior of the MEMS harvester.”

Optimizing Cantilever Size and Shape

“With COMSOL Multiphysics simulation software we learned how to numerically describe the behavior of our structure to then allow us to conduct research in the laboratory,” comments Dr. Kuehne. In order to compare the simulated behavior with experiments, the cantilever was periodically excited and the generated piezoelectric voltage was recorded.

“In that sort of time it is easy to simulate the performance of up to 2,000 different prototypes within COMSOL Multiphysics.”

“Comparison of the simulation with physical testing revealed that the overall damping behavior was actually higher. The obvious explanation was that we were losing energy because of intrinsic losses in the material. We assumed an accepted value for this internal damping, and after taking these correction factors into account, we arrived at the same results. This reassured us that our simulation process with COMSOL was reliable and that we could continue to investigate the performance of the cantilever using different parameter values.” The team was then able to move on to optimizing system components and system integration (Figure 7).

The use of COMSOL was critical to the development of the physical prototypes. According to Dr. Kuehne, it takes three people four months to do one technological run, which typically consists of one batch of up to 25 wafers. “One run usually results in a couple of complete prototypes, depending on layout. Testing takes a further two months. In particular, the extra expense of a clean room infrastructure results in development costs of more than 100,000 Euros for a single prototype run over six months. In contrast, you can measure a 2D simulation in hours and a 3D simulation in days. In that sort of time it is easy to simulate the performance of up to 2,000 different prototypes within COMSOL Multiphysics.”

Dr. Frey concludes, “Without COMSOL and the option of numerical modeling we would have to make numerous physical structures that would have been time-consuming and expensive. Instead, we were able to get on with the process of optimizing the MEMS design.” ■

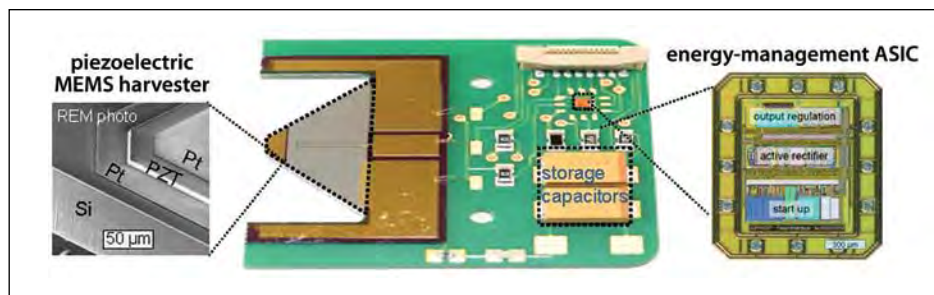

Figure 7. Prototype of a piezoelectric MEMS energy harvesting module and surrounding system.

RESEARCH PAPER

www.comsol.com/papers/11860/



Optimizing Ultrasound Piezo-Disk Transducers

The development of probes is pushing the design of ultrasound imaging forward. Thanks to COMSOL Multiphysics, Esaote has been able to investigate how to improve their performance, including bandwidth and steering performance.

BY LORENZO SPICCI AND MARCO CATI, R&D DEPARTMENT, ESAOTE S.P.A.

Medical ultrasound imaging has made great advances and provides ever more detailed diagnostic information. With the help of new ultrasound probe technology and signal processing, it's possible to greatly increase sensitivity, bandwidth, field of view and other key parameters. Bandwidth, in particular, is important; it provides not only greater image quality and thus diagnostic power by supporting many different frequency bands, it also means doctors need fewer probes (the name given to the handheld units placed on the body). Miniaturization makes it possible to deploy cost-effective ultrasound systems in many more applications and put them into use throughout a hospital or in specialty practices (Figure 1).

The design of the probes is bringing new advances. The quality of the final image is tightly related to the materials used in probe manufacturing and the understanding of their interactions.

This is exactly where a number of researchers at Esaote S.p.A. in Florence, Italy, are focusing their efforts. This company's principle activity is the manufacture and sale of diagnostic ultrasound imaging systems. Our firm has 1,350 employees, of which 20% are active in R&D, and annual global sales are in excess of 300 million Euros.

Material Models

Ultrasound transducers (Figure 2) involve specialized materials, manufactured through processes with specialized ma-

“A COMSOL model provides results in one month that otherwise would take a year and many prototypes to achieve.”

chines and layers as thin as 30 microns. This means that making multiple prototypes for testing is expensive. Further, we need to answer questions that can't be addressed by measurements or theoretical models. Often, we require information that the material suppliers themselves often don't have on hand, usually because they do



Figure 1. The performance of ultrasonic diagnostic systems such as MyLabOne (left) depends heavily on probes placed on the skin (right).



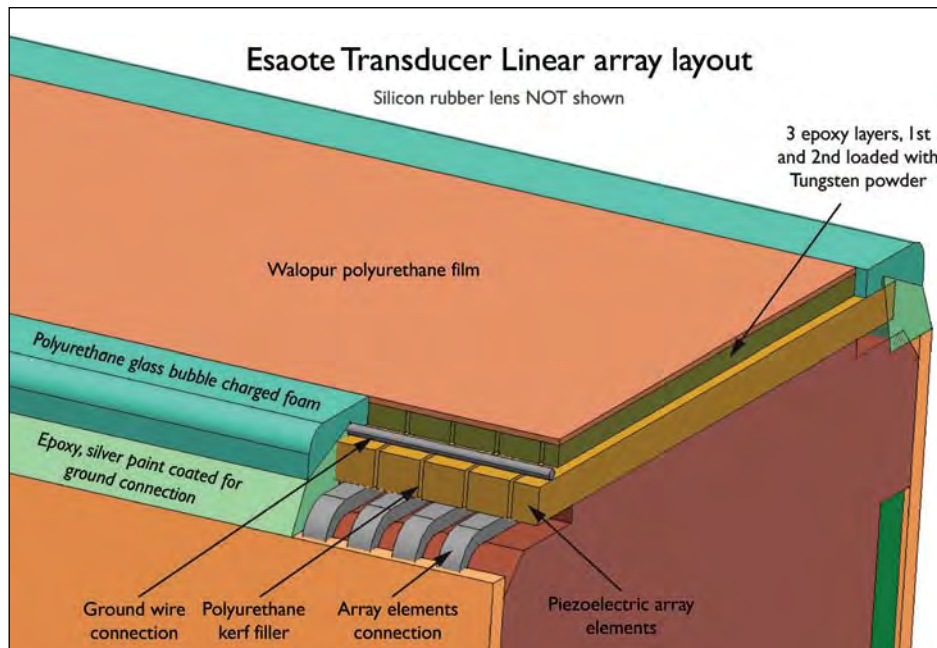

Figure 2. A complex geometry and the use of very specialized materials make the optimization of ultrasonic probes a challenging modeling task.

not consider the acoustic properties of their probes at the level of detail we require. You could even say that we know more about the materials than the suppliers.

With a simulation model, however, we can investigate changes in both the materials and operation. COMSOL Multiphysics has made this easy with dedicated structural-acoustics interactions as well as allowing the inclusion of other coupled physics. Best of all, a COMSOL model provides results in one month that otherwise would take a year and many prototypes to achieve.

Among the things we are examining is how the mechanical layers in the probes affect bandwidth. We can change many aspects of the manufacturing process and easily check if the geometrical aspects, such as the thickness of the ceramic layer, are best for our purposes. Moreover, the model allows the simulation of important properties such as directivity and beam-steering capabilities. Once we found a way to optimize these properties, we then ask the manufacturer to modify its product accordingly or change some of the features of our probe design.

Our first model (Figure 3) gave us a clear picture of the material properties and made it easy to recognize the effects of each on transducer performance. It in-

cluded a study of the piezoelectric material and critical elements to be considered in the transducer manufacturing stages, by simulating the electric impedance and far field pressure level (Figure 4).

The simulations also included a matching layer in front of the disk. This layer is important because, just as with an electric system where impedances must match to transfer maximum power, the same is true for transferring acoustic power from the piezo-disk to the human body. This acoustic impedance is measured in Mrayls. In this case, the ceramic material has a high acoustic impedance (30 Mrayls), while the biological material has a low value (1.5 Mrayls).

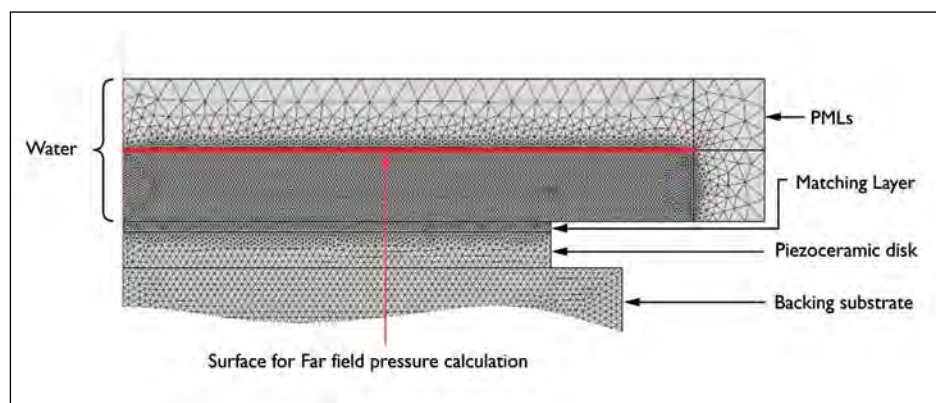

Figure 3. Model used to simulate the final far field pressure as well as the transducer's directivity performance when the substrate and front matching layer were included.

We found that the elasticity, piezoelectric and dielectric material properties were all equally critical in determining the behavior of the transducer, which meant that these parameters could not be simplified in a full model of the complete probe. Agreement between test measurements and simulation results were good over the entire frequency range, where the resonance and antiresonance frequencies fit each other within an error margin of approximately 3%. This gave us confidence in the techniques we used to model this type of application.

Further, by investigating the backing substrate, we also found that its parameters greatly affect the electrical impedance response.

In this first model, we used perfectly matched layers (PML) to reduce computational time and memory. For our transducers, it was important to study pressure in the far field region, and the simulated far field pressure was compared to measurements using a membrane hydrophone placed at 30 cm depth in a water tank. Biological tissue has acoustic properties very similar to water, which is often used as the standard for testing purposes. We found discrepancies of less than 5% at the maximum amplitude frequencies and differences of less than 1 dB for the corresponding amplitudes.

Modeling the Entire Probe

Having seen how well COMSOL worked for simulating the probe materials, our next model expanded the scope to include an actual probe with its very complicated geometry and operating configuration. It simulated a wideband 5-MHz linear ar-

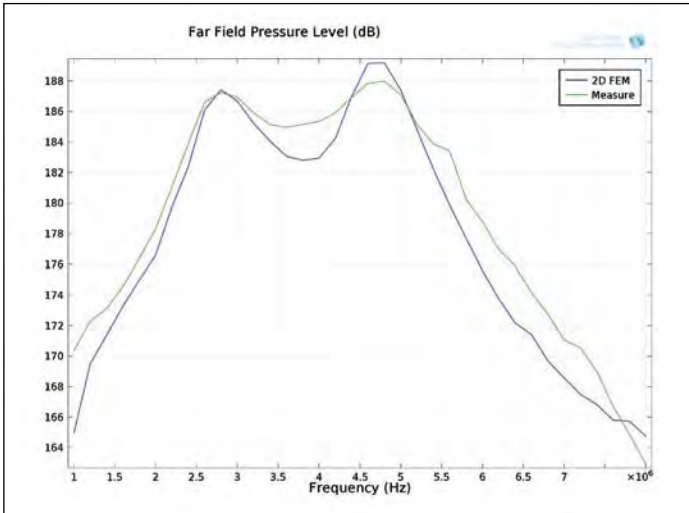

Figure 4. Far field pressure level (dB) from the initial model (Figure 3). Experimental and model results are in good agreement, which gives us confidence in the modeling technique.

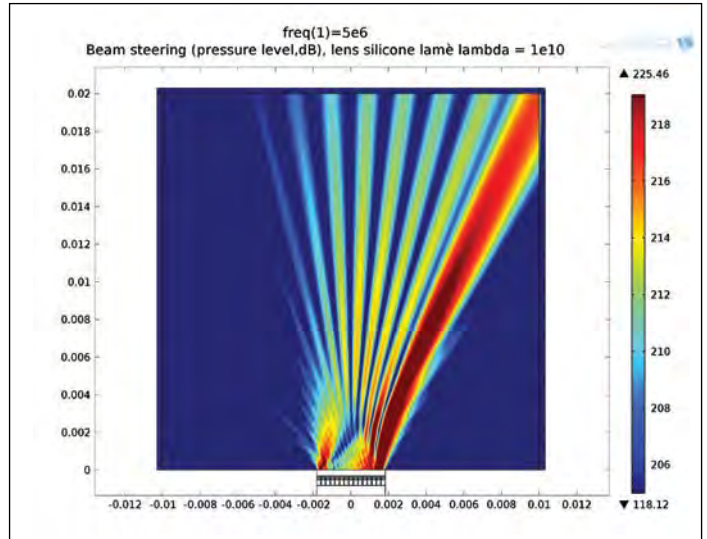

Figure 5. COMSOL model showing how the silicon lens allows the ultrasound beam to be steered or directed.

ray probe consisting of 144 piezoelements, with a pitch of 245 microns. The transducer design was made up of a special piezo-composite material, a hard rubber backing substrate, four acoustic matching layers and a silicon rubber lens. We also started to study beam focusing and steering so we could better specify the properties of the silicon rubber lens (Figure 5).

A further investigation was to see how well a COMSOL model could be augmented by integrating it with an equivalent circuit model based on the KLM (Krim-

holtz, Leedom, Matthaei) model. Using the KLM method together with the electric transmission-line matching theory, it was possible to determine the values of the matching layers' acoustic impedance and thickness that give a certain desired probe performance. With a given input specification for the probe (sensitivity, bandwidth), it was possible to run KLM simulations and calculate the optimized thicknesses for the four matching layers (easily placed into the COMSOL geometry) and the acoustic impedance (trans-

ferred to the Young's modulus and Poisson coefficient). The KLM model proved an easier, faster and more efficient tool to design the matching layer stack, which could then be implemented in COMSOL, and resulted in improved designs. ■

EDITOR'S NOTE

This work was presented at the 2010 COMSOL European Conference in Paris where it won the Best Paper Award. It can be downloaded from: www.comsol.com/papers/10141/.

About the Authors

Lorenzo Spicci (right) has been with Esaote Biomedical in Florence, Italy, for ten years as a materials engineer & piezo/transducer designer. He earned a "Laureate" degree at the Università degli studi di Firenze in Florence and then a Masters degree in Applied Physics at George Washington University in Washington, DC, USA.

Marco Cati (left) joined the R&D Department of Esaote Biomedica in Florence, Italy, in 2005, and is involved in EMC design and testing activities on ultrasound and magnetic resonance devices. He graduated *cum laude* and with an *encmum* citation in electronic engineering from the University of Florence, where he later obtained his PhD in electronic engineering. Since 2001, Dr. Cati has served as a technical inspector for the Italian accreditation body ACCREDIA.





Better, Faster Sonar Development with Multiphysics Simulation

BY GARY DAGASTINE, CONTRIBUTING EDITOR, TECH BRIEFS MEDIA GROUP

As any dolphin could tell us, sound travels well in water. While water absorbs electromagnetic radiation and light waves over relatively short distances, sound travels widely and even faster in water than in air. That's why we use sonar (SOund NAvigation Ranging), the acoustic equivalent of radar, to detect and locate underwater objects.

Sonar system developers continually seek to increase performance while also reducing size, weight, and cost, but this is easier said than done. Factors that must be taken into account include the characteristics of acoustic-wave propagation in water of varying densities, the vibrations and elastic waves that come into play with respect to the sonar system's materials and components, electrical considerations, and many others.

Building and testing a series of physical prototypes on a trial-and-error basis is one way to conduct system development, but this tedious approach is time-consuming, costly, and makes it difficult to achieve real-world performance close to the theoretical best case.

In contrast, the use of tightly coupled multiphysics modeling, simulation, and

“The use of tightly coupled multiphysics modeling, simulation, and visualization capabilities, such as those provided by the COMSOL software environment, can speed up system development exponentially and lead to a better end result as well.”

visualization capabilities, such as those provided by the COMSOL software environment, can speed up system development exponentially and lead to a better end result as well.

A case in point is the development of a new type of sonar acoustic projector, designed to provide improved performance

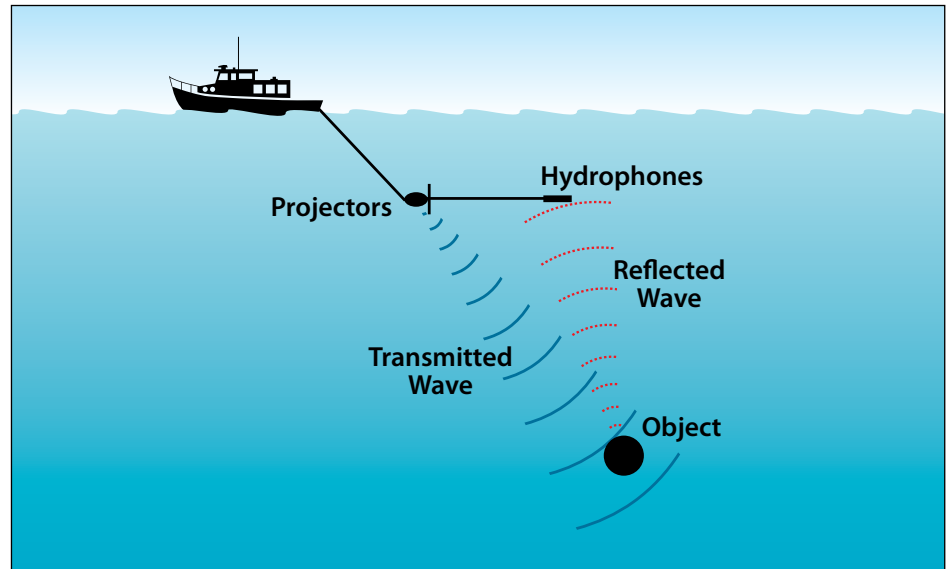

Figure 1. Sonar uses transmitted and reflected sound waves to locate underwater objects.

at half the size and weight of existing projectors. Stephen Butler, an Acoustical Engineer and Principal Investigator at the U.S. Navy's Naval Undersea Warfare Center Division Newport in Newport, RI, used COMSOL Multiphysics with the Acoustics Module to accelerate the development of the new projector.

The Naval Undersea Warfare Center Division Newport provides research,

Sonar Basics

A sonar system consists of a projector to transmit acoustic energy and an array of hydrophones to receive the reflected sound waves from underwater objects. Sound waves are not generally unidirectional, though, so one key design goal is to increase the strength of the acoustic beam in one direction and to null it in the other. This will result in a more precise acoustic beam, which increases the sonar system's capability to detect objects (Figure 1).

Some acoustic projectors are based on flexensional transducer technology. These are rugged, high-power, and compact devices, with an actuator such as a piezoelectric ceramic stack positioned between curved metal shells or staves made from aluminum, steel, or fiberglass. The staves may be either convex or concave, but are usually convex in conventional devices (Figure 2). The actuator is fixed to each end of the curved shells so that as it expands and contracts with an applied electric field, that motion is converted into flexure of the shells with an approximately 3:1 amplification in motion. These flexures produce acoustic energy in a manner similar to that of an acoustic loudspeaker's cone.

development, test and evaluation, engineering, analysis and assessment, and fleet support capabilities for submarines, autonomous underwater systems, and offensive and defensive undersea weapon systems. The Center also stewards existing and emerging technologies in support of undersea warfare.



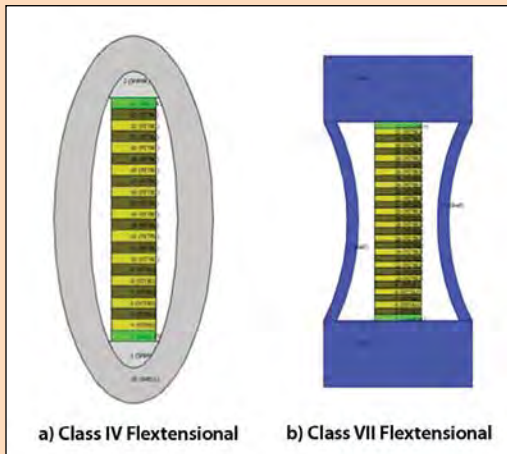

Figure 2. The images show (a) a conventional Class IV flextensional transducer, and (b) the new Class VII “dogbone” directional flextensional transducer.

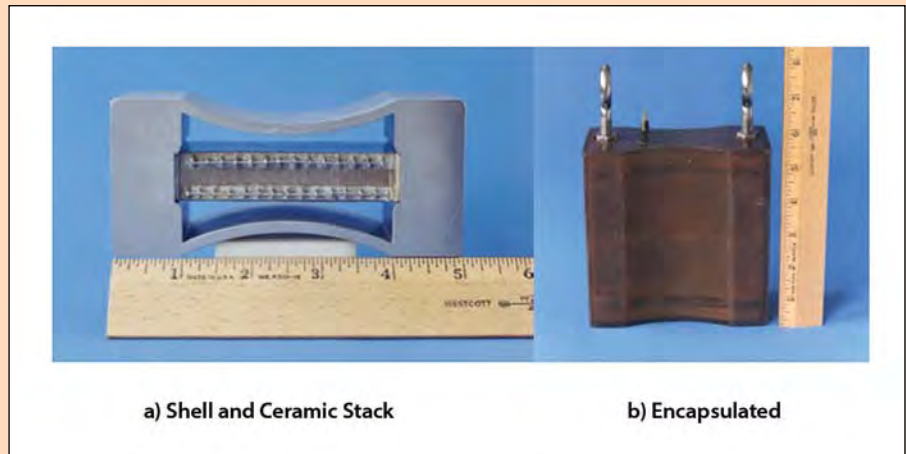

Figure 3. These images of the Class VII dogbone flextensional prototype sonar transducer show (a) the shell and ceramic stack, and (b) the encapsulated unit.

Butler used COMSOL to perform multiple computer analyses, which allowed data manipulation to determine the effects of all possible design variables. The software was key to his ability to calculate the complex AC voltage drive coefficients required to drive the transducer into the directional mode.

Creating Directional Beams

A flextensional transducer is physically small compared to the acoustic wavelength produced, and thus its acoustic output tends to radiate omnidirectionally. This is undesirable in some sonar applications. A common method used to generate a directional beam with a null in one direction (a cardioid beam pattern) is to employ multiple transducer elements spaced one-quarter of a wavelength apart. However, the use of multiple elements creates diffraction effects that limit the directionality of the acoustic output, or the front-to-back pressure ratio, to a modest 6 dB. They also increase the sonar system’s size and weight.

Butler was able to improve on conventional technology by using COMSOL Multiphysics to accelerate the development of a new class of device known as a di-

rectional “dogbone” (Class VII) transducer. It generates highly directional beams from a single element instead of from an array of elements, thus reducing diffraction, size, and weight. The word “dogbone” refers to the shape of the device, which uses two concave shells, or beam-radiating surfaces (Figure 3).

Key to the new device is its piezoelectric ceramic stack, which has two active sections separated by an inactive section along its major axis. Driving both sides of the stack in-phase allows the shell to be driven in conventional mode, which creates an omnidirectional radiation pattern. However, a dipole radiation pattern is created when the two sides are driven 180 degrees out-of-phase with one another, because the stack bends in response to the applied electric field and excites an asymmetric mode in the shell.

By combining the omnidirectional and dipole modes through the use of appropriate AC drive voltage coefficients, the acoustic pressure output can be doubled in one direction and nulled in the other direction, resulting in a highly directional cardioid beam pattern. These complex drive coefficients would have been difficult to deter-

mine without advanced, tightly coupled multiphysics modeling and simulation capabilities (Figures 4 and 5).

As a result, the new directional dogbone flextensional transducer can generate a unidirectional cardioid radiation pattern with a front-to-back ratio greater than 20 dB at the null, independent of operating frequency. Moreover, this cardioid pattern is developed over an octave frequency band, meaning it operates over a wide bandwidth and thus is more versatile and useful in generating waveforms than conventional flextensional transducers.

COMSOL’s Acoustics Module was used because it includes structural, acoustics, and piezoelectric elements. It is tightly coupled with the company’s overall multiphysics software environment such that one can easily construct a structural computer model, determine its modal harmonic content, and predict its directional performance.

The Making of a New Transducer

The first step in developing the new transducer was to create a one-dimensional equivalent-circuit model of it to characterize its resonance modes. Equivalent circuit models are simple representations of an electromechanical device that include its material properties. They consist of an arrangement of simple electrical components: inductors, capacitors, and resistors.

In the equivalent-circuit model, voltage would represent a force, electrical current



Stephen Butler is an acoustical engineer and principal investigator at the U.S. Navy’s Naval Undersea Warfare Center Division Newport in Newport, RI.



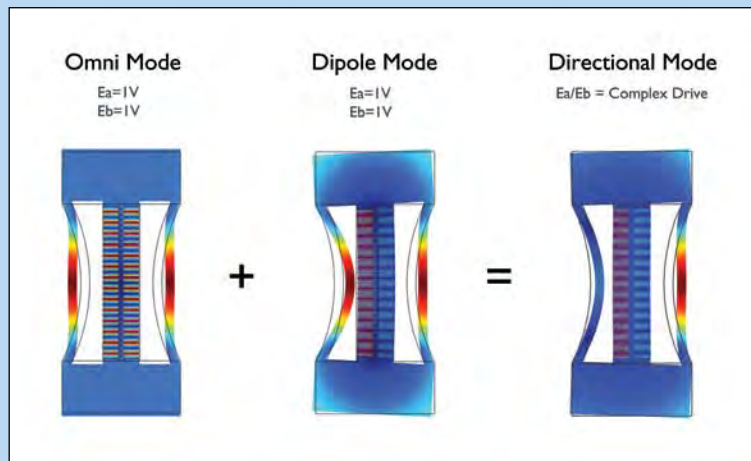

Figure 4. These images rendered by COMSOL illustrate the operational modes of both the shell and stack with regard to both physical displacements in the shell and electric fields in the piezoelectric stack.

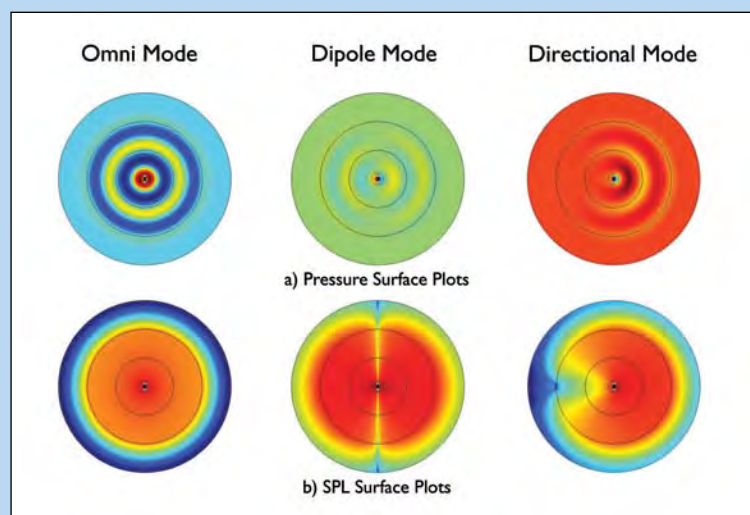

Figure 5. The COMSOL-modeled (a) Surface Pressure Plots and (b) Surface Pressure Level (SPL) surface plots in the omnidirectional, dipole, and directional modes.

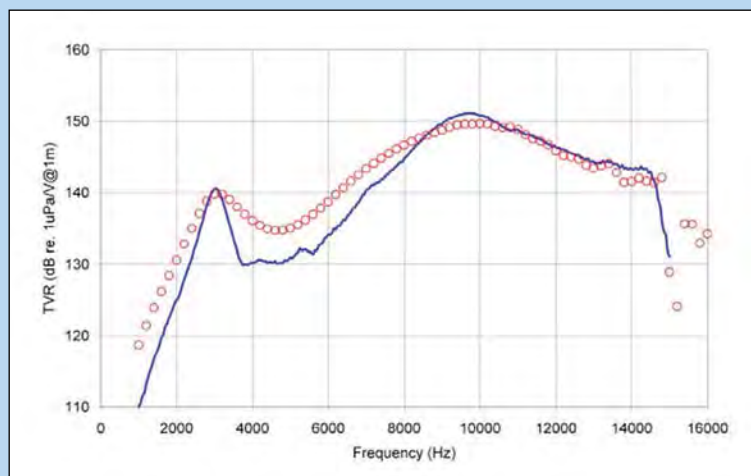

Figure 6. The plot shows the in-water transmit voltage response: Measured blue line versus COMSOL-modeled red dots.

would represent a velocity, inductance would represent a mass, and capacitance would represent a spring. Once the equivalent-circuit model had satisfactory results, it was refined by the software to create improved two- and three-dimensional structural computer models. The computer models were validated by comparing them to actual in-air and in-water data obtained by physically measuring the resonances of an experimental Class VII omnidirectional-mode dogbone flextensional transducer.

The validation of the software modeling was a multi-step process. First, the modeled piezoelectric ceramic stack characteristics were compared with the physical stack. Then, the modeled shell modes of vibration were compared with the physical shell. Finally, the modeled stack with the shell was compared with the physical integrated unit.

The results of these modeled vs. measured data comparisons were so close, it gave full confidence in the ability to use simulation to establish a baseline to predict the real-world performance of the directional dogbone device to be built (Figure 6).

Both far-field acoustic pressures of the omnidirectional and dipole modes were predicted and, in turn, these were used to determine the complex drive coefficients required to drive the transducer into the directional mode.

Also, the model of the piezoelectric stack could be divided into two active halves, enabling the impedance of each side of the stack to be independently determined. This made it easier to understand how to drive each half, and thereby to derive the proper AC voltage drive coefficients for each half.

This understanding would have been extraordinarily difficult to obtain otherwise. COMSOL's coupled-acoustic modeling capability was essential to get the "null" value for the back of the device, because it enabled Butler to get the in-fluid acoustic pressures and the in-fluid phase values individually. Without the ability to do that, it wouldn't have been possible to derive the drive coefficients.

Major Improvement

In today's world of undersea warfare, the threats and the necessary responses to them are getting more difficult, important, and urgent. Sonar is a key element of national defense and modern sonar development efforts benefit greatly from powerful modeling, simulation, and visualization capabilities. ■

FOR MORE INFORMATION

This article is based on S.C. Butler's "A Directional Dogbone Flextensional Sonar Transducer," COMSOL Conference Proceedings, Boston, October 2010. Visit www.comsol.com/papers/7916/ to view the full presentation.





Figure 1. A recently commissioned Alstom electrostatic precipitator placed after an 850 MW lignite-fired boiler in Poland.

Numerical Modeling of Electrostatic Precipitators

Despite all the press given to alternative sources of power, we still rely heavily on using coal for energy production. Alstom designs electrostatic precipitators that are used to clean flue gas, and researchers are using both experiments and simulations to study and optimize these units.

BY ANDREAS BÄCK, ALSTOM POWER SWEDEN AB AND JOEL CRAMSKY, ALVELID ENGINEERING AB

Because of coal's abundance and relatively low cost, it is the primary source of electricity generation around the world. Global coal demand has almost doubled since 1980, driven mainly by increases in Asia where demand is up over 400% from 1980 to 2010. In the United States coal is used to generate about half of the electricity and remains the largest domestically produced source of energy.

A natural result of burning coal is the emission of fly ash, consisting of fine particles derived from mineral matter in the fuel. Increasingly strict emission and environmental standards dictate that virtually all of the dust resulting from coal combustion must be removed. Particle emission limits in the range of 10 – 30 mg/m³ in the exiting flue gas are common today. Basically, all power plants and many industrial

processes employ either electrostatic precipitators (ESPs) or fabric filters to separate particles from the flue gas. The ESP is popular due to low operating and maintenance costs as well as robustness towards process variations (Figure 1). Particle removal efficiencies of 99.9% are common, and the world ESP industry has an annual turnover of several billion USD.

The Principles at Work

An ESP uses electrical forces to remove particles from the flue gas. High-voltage discharge electrodes, typically operating at 70 – 100 kV, produce a corona discharge, which is an ionization of the gas in the vicinity of the discharge electrode. The ions then follow the electric field lines and attach themselves to airborne particles in the flue gas that flows through the ESP, essentially charging them. The charged particles then migrate in the electric field and are collected on grounded metal plates, called collecting electrodes, where they build up to form a dust cake, which is periodically cleaned off. An ESP typically consists of frames with discharge electrodes placed between large metal curtains, acting as collecting electrodes (Figure 2). The ex-

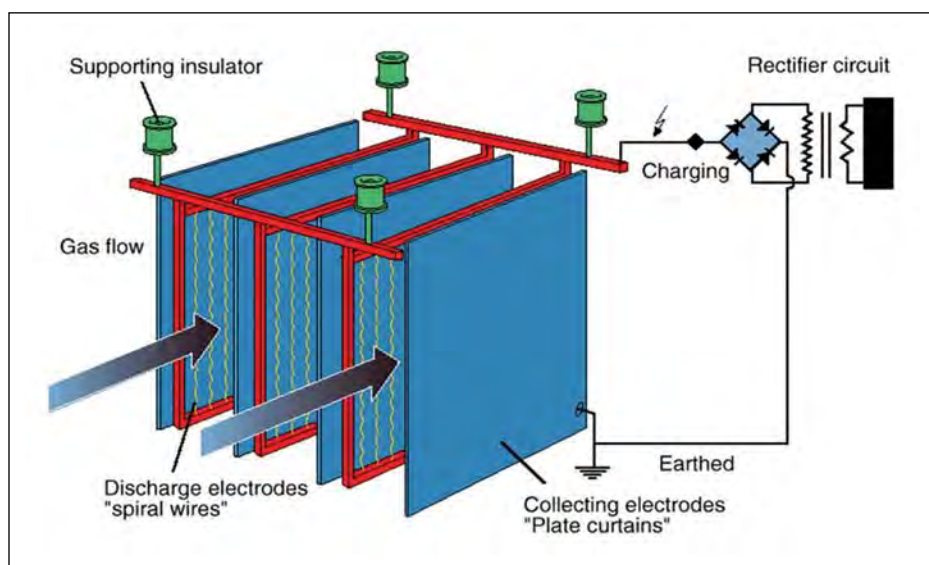

Figure 2. Diagram of a duct-type ESP. Note that the use of a negative-polarity corona is shown through the direction of the diodes in the rectifier bridge.



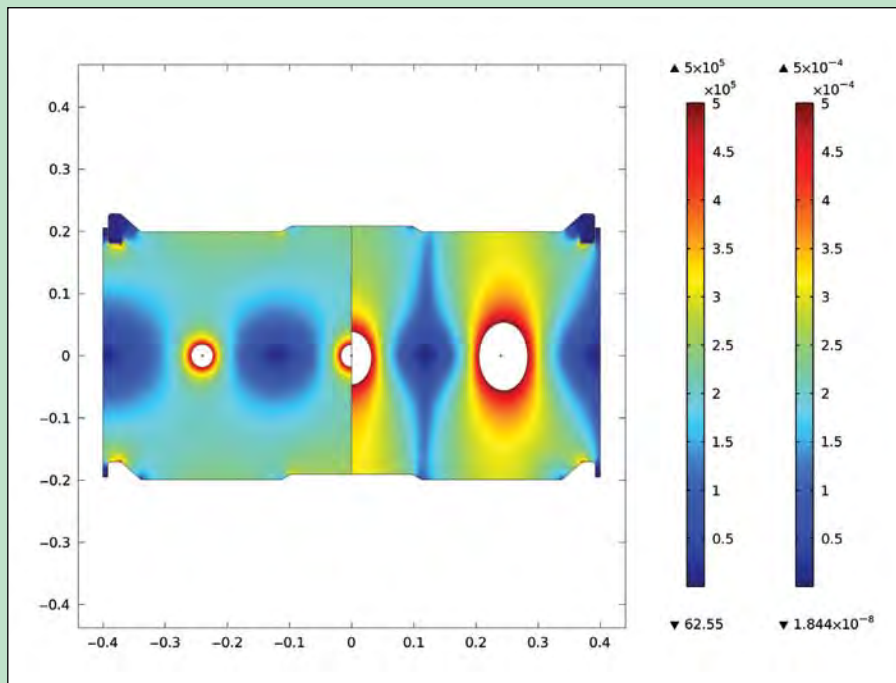

Figure 3. Composite color map of electric field intensity (left) and current flux (right) for a 2D geometry with straight wires and profiled collecting plates. The electric field and current flux intensity is clearly seen to be enhanced at the plate perturbations.

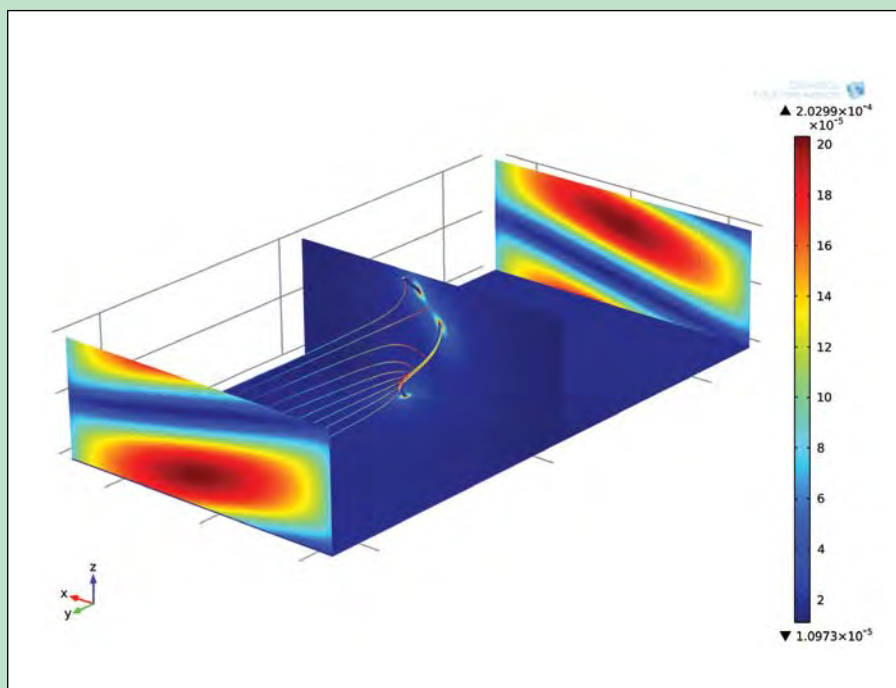

Figure 4. 3D model of a spiral electrode with flat collecting plates. The current density on the collecting plate is shown as the surface plots at the two ends of the model with a maximum of $200 \mu\text{A}/\text{m}^2$. The other two plots, which are horizontal and vertical slices intersecting with the spiral electrode, show the magnitude of the electric field. This is greatest in the corona region closest to the spiral. Also shown are electric field lines that indicate the direction of the field emanating from the spiral.

terior dimensions of an ESP can be as large as $50 \times 50 \times 25$ meters divided into many independently, energized sections.

Increasing the ESP collection efficiency, reducing power consumption and optimizing the design from a cost perspective are part of the work at Alstom Power Sweden AB. The Alstom technical center in Växjö serves as the global R&D execution center for the company's studies of environmental control technologies, including particle separation, flue gas desulfurization, catalytic NO_x conversion and CO₂ abatement. ESP development has traditionally been mainly an experimental and empirical science, although

“With COMSOL Multiphysics it was easy and straightforward to create mathematical models that provided a deeper understanding of the detailed behavior inside the ESP.”

some numerical studies on selected phenomena of the precipitator have also attracted interest. With COMSOL Multiphysics it was easy and straightforward to create mathematical models that provided a deeper understanding of the detailed behavior inside the ESP.

Modeling the ESP

To achieve the mechanical stability required for a tall collecting plate, it must be profiled or shaped. Because the electric field strength at the plate surface determines when a spark-over (short-circuiting) occurs, it is very important to have smooth curvatures that do not create points of exceptionally high field strength. We studied this with the model in Figure 3, which shows a top view of a symmetry cell of an ESP, having three wires centered between the profiled collecting plates seen in the top and bottom. From this model, it is seen how the electric field is significantly enhanced by the perturbations on the collecting plates.





By comparing experimental observations of spark-over voltages with numerical results for the electric field, it was seen that sparking occurred at roughly the same electric field at the collecting plate. This supports the general theory that the maximum local electric field strength at the grounded plates is the critical factor for sparking inside a precipitator.

We developed the first 3D models to study the spiral discharge electrode, which is often used in Alstom ESPs due to its even current distribution. Modeling the corona became more elaborate in 3D because the electric field now becomes highly non-uniform on the spiral surface (Figure 4). The model clearly shows the pronounced nodal pattern of the current distribution on the collecting plates, which is also confirmed by experimental measurements. The current distribution on the plates is an important factor in operating ESPs if the collected dust has a high electrical resistivity, because the combination of a high current and resistivity may cause unwanted ionization inside the dust layer (“back-corona”).

Comparing Results with Experiment

By comparing numerical results with the corresponding data obtained in an experimental high-voltage rig, confidence in the numerical models can be gained. This is exemplified by the current distribution on the collecting plates. In the high-volt-

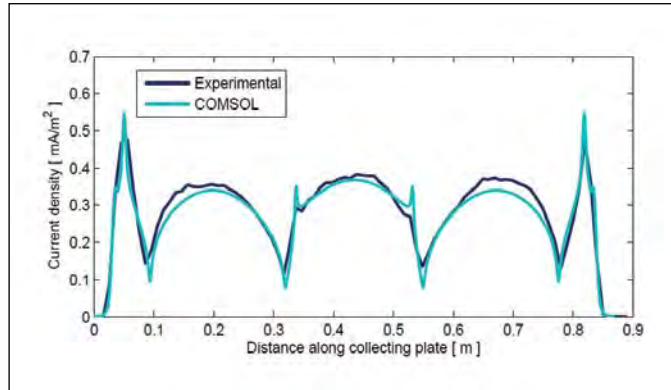

Figure 5. Current distribution entering the collecting plates according to experimental measurement and numerical simulation. The “current spikes” are due to the profiling of the plate. The average current density corresponds to 250 $\mu\text{A}/\text{m}^2$.

age rig, the current profile on the collecting plates could be measured by gluing a special foil onto the electrode surface. Results from experiments using straight wires and profiled collecting plates were compared with COMSOL results (Figure 5). These showed excellent agreement, and gave confidence in the modeling technique to continue with more advanced simulations.

Further Observations

Contrary to the general sizing theory of precipitators based on the so-called Deutsch equation, field experience has shown that the spacing of the collecting plates inside the ESP may typically be increased without having a negative impact on collection efficiency. Thus, to save on material and costs, the standard spacing has increased from 250 mm to 300 mm and then to 400 mm, which can be regarded as the industry standard

today. The modeling showed that the migration velocity of a particle traveling towards the plates increases with greater spacing due to a shift of the electric field in the inter-electrode region.

A potential problem with ESP operation is what is known as corona quenching or the dust space charge effect. This occurs when the total surface area of the particles entering the ESP is very large, meaning that a large part of the charge in the inter-electrode space is carried by

slow-moving dust particles rather than ions, reducing the overall current for a given operating voltage. With a simple COMSOL model it was easy to estimate the level of corona quenching and relate it to the incoming dust concentration using a semi-empirical approach. The fly ash concentration and particle size distribution from a typical coal-fired boiler would completely quench the corona if all particles were fully charged. Thus, it is only after a significant fraction of the dust has been precipitated that the remaining suspended particles can reach their saturation charge. ■

FURTHER READING

A. Bäck and J. Cramsky; “Comparison of Numerical and Experimental Results for the Duct-Type Electrostatic Precipitator”; *International Journal of Plasma Environmental Science & Technology*, Vol. 6, pp 33-42, 2012.

About the Authors

Andreas Bäck (left) has a MSc. degree in electrical engineering from Chalmers University of Technology and a PhD. in physical chemistry from Gothenburg University. Since 2004 he has been working as research engineer and technology manager at the Alstom technical center for environmental control equipment in Växjö, Sweden. The work has mainly focused on R&D and technical support in the area of electrostatic precipitation, both in the testing facilities in Växjö and at various ESP installations around the world.

Joel Cramsky (right) received his MSc. degree in engineering physics from the University of Lund after thesis work on numerical computations for electrostatic precipitators at Alstom Power in Växjö. After graduation he continued the investigations of his MSc. thesis at Alstom. He is currently working as a structural engineer at Alvelid Engineering in Kalmar, Sweden.





Current Transformer Design That Combines Finite Element Analysis and Electric Circuit Simulation

Transient simulation of a transformer that makes use of a thermal-electromagnetic FE analysis integrated with an electrical circuit SPICE model is underpinning the development of sensor technology at ABB.

BY JENNIFER HAND

The design of sophisticated magnetic sensors and actuators demands a thorough understanding of their components and the electric and magnetic interaction they have with the environment. In electric current transformers and sensors, which are used to measure the electrical current in power distribution and control systems, the secondary winding is usually operated at close to short-circuit conditions to ensure small impedance, reduce electric current errors and avoid high voltages at the secondary side. However, in the real world there will always be deviations from ideal behavior because of material properties, design details, dynamic loading or other interactions.

“Finite element analysis (FEA) is a powerful means of investigating the way in which external electrical sources and loads interact with a magnetic subsystem like a transformer core. FEA illustrates the transient behavior of these cores and

the generated flux density distributions. It also elucidates the self-heating and effects of temperature-dependent material properties that need to be taken into account,” comments Dr. Rolf Disselnkötter, Senior Principal Scientist specializing in Industrial Sensor Technology at the ABB Corporate Research Centre in Ladenburg, Germany. “It is particularly important if the shape of



Dr. Rolf Disselnkötter, Senior Principal Scientist specializing in Industrial Sensor Technology at the ABB Corporate Research Centre in Ladenburg, Germany.

“We are looking at how various design parameters influence performance. From this, we are building up knowledge that ABB can apply to the future development of magnetic sensors, actuators and other magnetic components.”

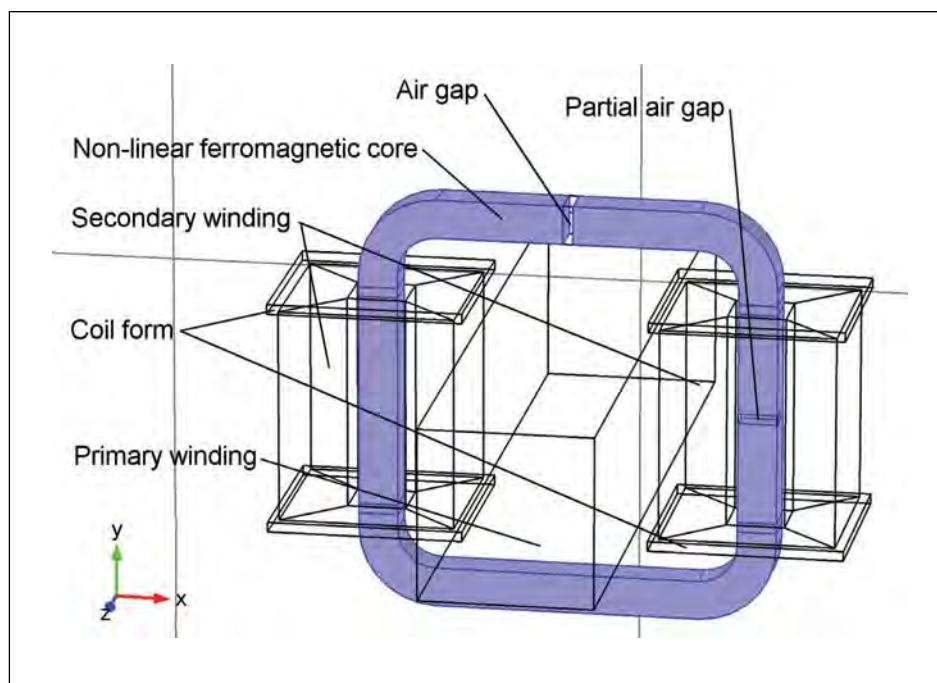

Figure 1. Geometry of the 3D transformer model with the ferromagnetic core in blue.





a component is complex and its behavior cannot easily be foreseen.”

Dr. Disselnkötter is working with engineers from the University of Dresden, and they have been using COMSOL Multiphysics for the past three years to develop modeling techniques for use in different applications. “We are looking at how various design parameters influence performance. From this, we are building up knowledge that ABB can apply to the future development of magnetic sensors, actuators and other magnetic components.”

The coupling of different physics is one of the fundamental challenges in the models, which already combine 3D geometry, magnetic non-linearity and transient analysis. “We are working towards advanced models that will combine several of these characteristics.”

Understanding the Interactions

Figure 1 shows the geometry of the team’s most recent test model, which allows transient FE analysis of transformers that are integrated with models of external circuitry. Dr. Disselnkötter explains: “We are interested in how

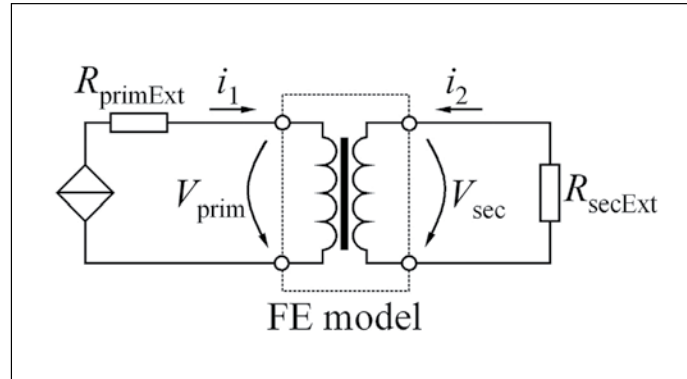

Figure 2. Primary and secondary circuits coupled to the FE model of the transformer.

geometrical design variations, material properties, primary current distribution, temperature and the electric circuitry will impact the accuracy of the electric current measurement. In order to allow for easy modifications and subsequent optimization procedures, we use parameter-based 3D model geometries. Because we want to highlight potential problems we made this model transformer intentionally ‘bad’. It therefore has small air gaps so that we can understand the effects these have.”

Apart from the deliberate air gaps on the right and at the top, this is a typical transformer with the primary winding made up of one turn (a bulk bus bar)

and the secondary winding consisting of multiple turns that are arranged on two coil bobbins. The magnetic system is described by Ampère’s circuital law and by Faraday’s law of induction. For the core material a nonlinear relationship between the flux density B and the magnetic field H of the type $H = f(|B|) \cdot B/|B|$ is assumed. Because of this, precise modeling of the electrical signals requires a time-dependent

simulation. Further, the air gaps lead to an asymmetrical geometry and cause an imperfect coupling between the primary and secondary windings.

Integrating with a Circuit Model

Figure 2 shows how the FE model of the transformer was integrated with a circuit model and coupled to a sinusoidal current source at the primary side and an external load resistor at the secondary side. “We built the circuitry from the predefined components provided with COMSOL Multiphysics rather than importing it as a SPICE netlist,” comments Dr. Disselnkötter. “The coupling with the magnetic model was then

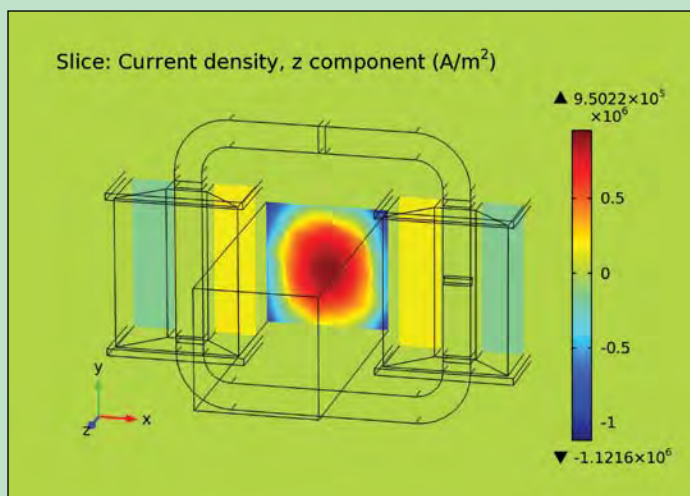

Figure 3. Simulated z-component of the total current density in the current carrying domains with skin effect in the primary conductor ($i_{1peak} = 1000$ A, $R_{secExt} = 20 \Omega$, $t = 0.23$ s).

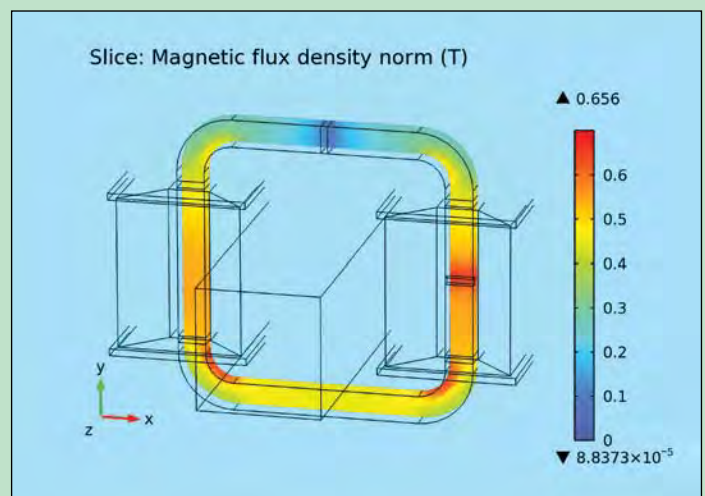

Figure 4. Simulated norm of the magnetic flux density in the center plane of the ferromagnetic transformer core ($i_{1peak} = 1000$ A, $R_{secExt} = 20 \Omega$, $t = 0.23$ s).





implemented with equations for the currents and voltages on the two sides of the transformer.”

Eddy Currents

Both the electrical losses and the magnetic field distribution will depend on the current density distribution in the conductors. As an electric current alternating at high frequency will induce a changing magnetic field, and in turn an electrical field, the team wanted to model the eddy currents that would arise and therefore modify the current distribution in the conductors. “Modeling this is a bit tricky,” comments Dr. Disselnkötter, “as it is not the external current but the resulting total current that needs to be coupled to the circuit. In bulk conductors, like the primary bus bar of our model, the total current will be much lower due to the counteracting eddy currents. We therefore used a global equation approach to ensure that the total primary current follows the prescribed sinusoidal time course.”

In this way, the model computes the space and time-dependent eddy current density in the primary conductor, and the resulting flux density distribution in the magnetic core (Figures 3 and 4). “This is important for a precise calculation of the current error and the losses incurred by our non-ideal transformer.” (Figure 5)

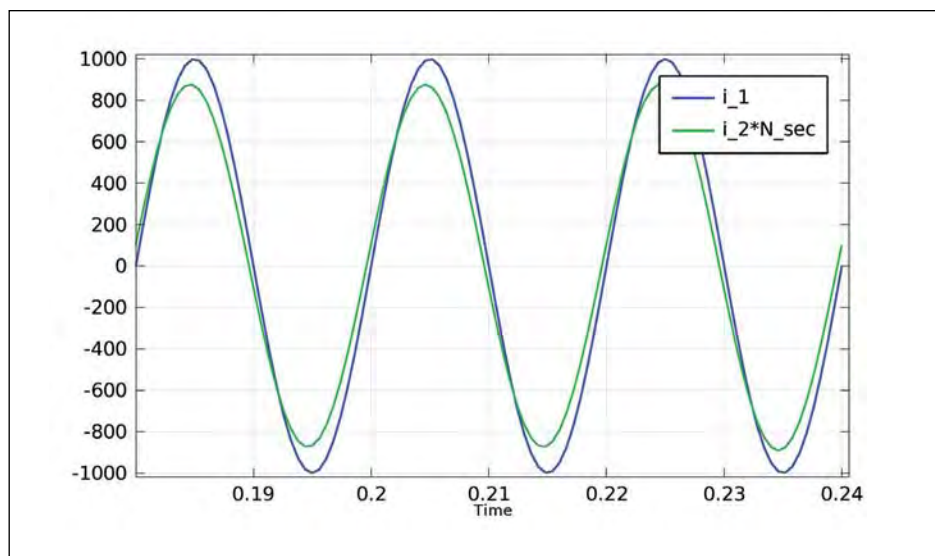

Figure 5. Simulated primary current i_1 and secondary current $i_2 \times N_2$ show an imperfect transformer coupling due to the air gaps in the core ($i_{1peak} = 1000$ A, $R_{secExt} = 25 \Omega$)

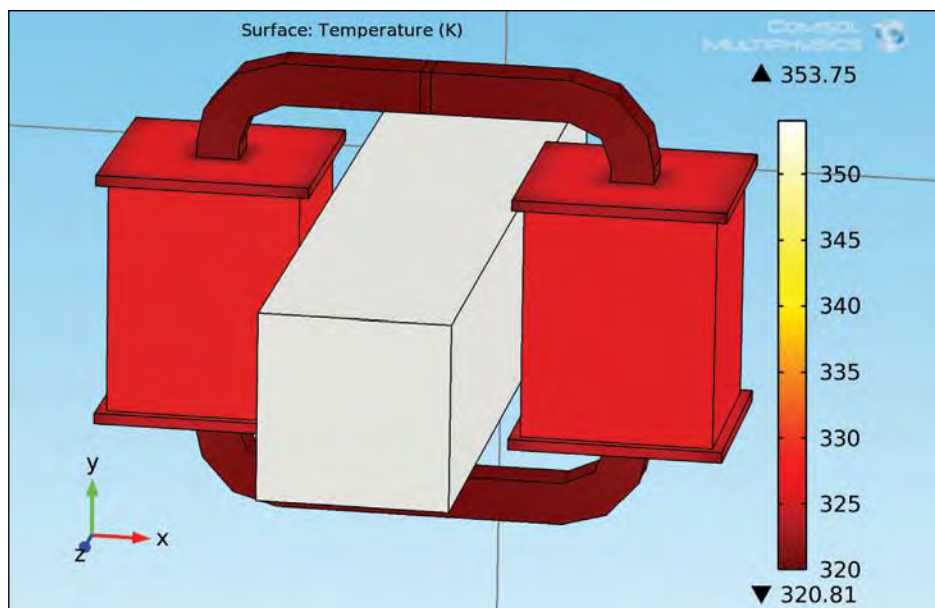

Figure 6. Simulated stationary temperature field at the surfaces of the solids ($i_{1peak} = 1000$ A, $R_{secExt} = 20 \Omega$, $T_{amb} = 300$ K).

Transient Thermal-Electromagnetic Simulation

COMSOL Multiphysics was also used to build the thermal model, which took into account both heat conduction in the participating solid materials as well as external convection on surfaces by means of convection coefficients.

In general, electrical and magnetic material properties are temperature-dependent, so the effects of self-heating also had to be considered. As a result the electromagnetic FE model was fully coupled to a thermal

FE model of the assembly. In most applications, however, the time scales of the electromagnetic and the thermal model are very different, so the team decided to iterate alternate solutions of the two models. The homogeneous temperature field was used as input for the first time-dependent study step of the electromagnetic model. After three or so simulated current periods the time-averaged local power loss density was obtained as a new input to the thermal model. In the following thermal simulation, the new temperature field was calculated and sent back to the electromagnetic model. The solutions converged within five iteration loops, leading to the temperature field shown in Figure 6. Also, the results shown in Figures 3 to 5 have been influenced by this temperature distribution.

The team is continuing this work. “We are looking for more accuracy and need to include further details, like the effects of the transformer core lamination and the anisotropic structure of the coils. In order to check the validity of the models, we plan to compare simulation results with accurate measurements on real magnetic components. Ultimately, we want to know that we can rely on our models and use them to optimize design processes.” ■

RESEARCH PAPER

www.comsol.com/papers/8233/



Modeling Scar Effects on Electrical Spinal Cord Stimulation

Simulation enabled doctors to learn how implanted electrodes treat back and leg pain.

BY EDWARD BROWN, CONTRIBUTING EDITOR, TECH BRIEFS MEDIA GROUP

Since the 1960s, spinal cord stimulation (SCS) has been used to alleviate chronic back and leg pain. The process involves surgically implanting a series of electrodes, which are used to apply electrical potentials directly to the spine (Figure 1). Although approximately 30,000 such procedures are performed each year,

“We decided to do very sophisticated geometry, much more so than anything that had been done in the past.”

there is still not a precise understanding of its mode of action. SCS somehow interferes with the human pain signaling circuitry. During the past 15 years, researchers have just been starting to develop a more detailed understanding of the effects of this stimulation. What makes the method attractive is that it is known to have beneficial results without many of the side effects of long-term pharmacological treatment.

One of the phenomena associated with this treatment is that it remains effective for many years, although over the course of time the stimulation generally has to be reprogrammed to modify the original parameters. As early as four to six weeks after the electrode is implanted, scarring occurs at the interface of the electrode and the surrounding tissue. Paradoxically, while this helps keep the paddle that holds the electrodes securely in place, it alters the electrical characteristics of the system, so that the stimulation has to be reprogrammed. The reprogramming is generally done by trial and error.

Research into this phenomenon was performed by Doctors Jeffrey Arle, a neurosurgeon with a degree in computational neuroscience; Jay Shils, who

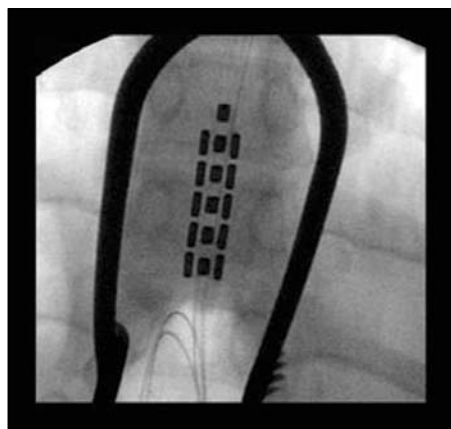

Figure 1. X-ray image of stimulator electrode array on the spinal cord for treatment of chronic back pain.

has a background in electrical engineering and computational neurophysiology; and Kris Carlson (Ph.D.), who has expertise in programming and along with Dr. Shils, has become an expert in using COMSOL software. They are all with the Neuromodulation Group at Lahey Clinic in Burlington, MA, and have concluded a study based on the hypothesis that the formation of relatively higher-resistance

scar tissue alters the impedance seen by the implanted electrodes, which in turn alters the pattern of the electric field distribution. It was their thesis that proved that a 3D mathematical model could be used to accurately predict these changes and define corrective modification of the stimulus pattern. This could reverse the often-observed deterioration in the performance of the treatment.

Modeling

Drawing on extensive earlier work done by their group, they had a great deal of data on precise measurements of the spinal cord segments, estimations of numbers of neurons, and the numbers of each type. They were also able to draw on detailed published work on the white matter (axons — the “wiring” that carries signals from neurons in the spine up to the brain). Their plan was to store this data as a digital database so that it could be accessed and manipulated. This database was then used to build a 3D model of the spinal cord, one that is much more accurate than anything that had been done in the past.

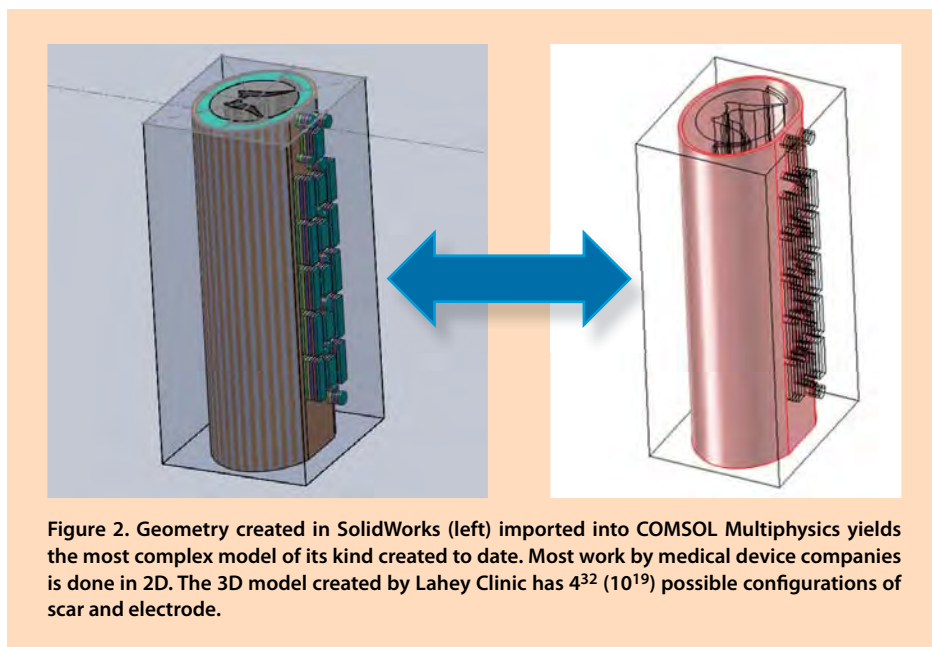

Figure 2. Geometry created in SolidWorks (left) imported into COMSOL Multiphysics yields the most complex model of its kind created to date. Most work by medical device companies is done in 2D. The 3D model created by Lahey Clinic has 4^{32} (10^{19}) possible configurations of scar and electrode.

The basic structure of the model was built using the SolidWorks CAD platform. The SolidWorks model could then be imported into COMSOL Multiphysics for solving some of the critical problems encountered with SCS (Figure 2). “The great advantage of COMSOL is that you can not only import CAD from SolidWorks, but you can subsequently make changes in these geometries, press a button, and these changes appear in the COMSOL model without losing any of the settings or material properties,” said Carlson. “The LiveLink for SolidWorks really helped in streamlining the process.”



Discussing the spinal cord stimulation modeling results. From left: Kris Carlson (Ph.D.), and Doctors Jeffrey Arle, and Jay Shils, all with the Neuromodulation Group at Lahey Clinic in Burlington, MA.

Computing

The goal of this particular project was to examine to what extent scar formation affects the electrical field distribution between the electrodes and axons. This is important because the axons running through the spinal cord (the white matter) are either activated or not, based upon the strength of electrical stimulation, which is governed by the gradient of the potential field. This is significant because it's the axons that carry the pain control signals to the brain.

“They had to understand exactly what in the spinal cord actually gets stimulated — that’s where the COMSOL software came in.”

It was their goal to learn just how the implanted electrodes accomplished the treatment of the pain. So part of the process was modeling the circuitry in the spinal cord and the effects of the electricity on that circuitry. In order to get to that stage, they had to understand exactly what in the spinal cord actually gets stimulated — that’s where the COMSOL software came in — to “model the electric fields from the electrodes themselves and all of the tissue characteristics they pass through,” said Dr. Arle.

The spinal cord is essentially floating in cerebrospinal fluid (CSF), which is in turn surrounded by a tube-like membrane called the dura. The stimulating electrodes sit

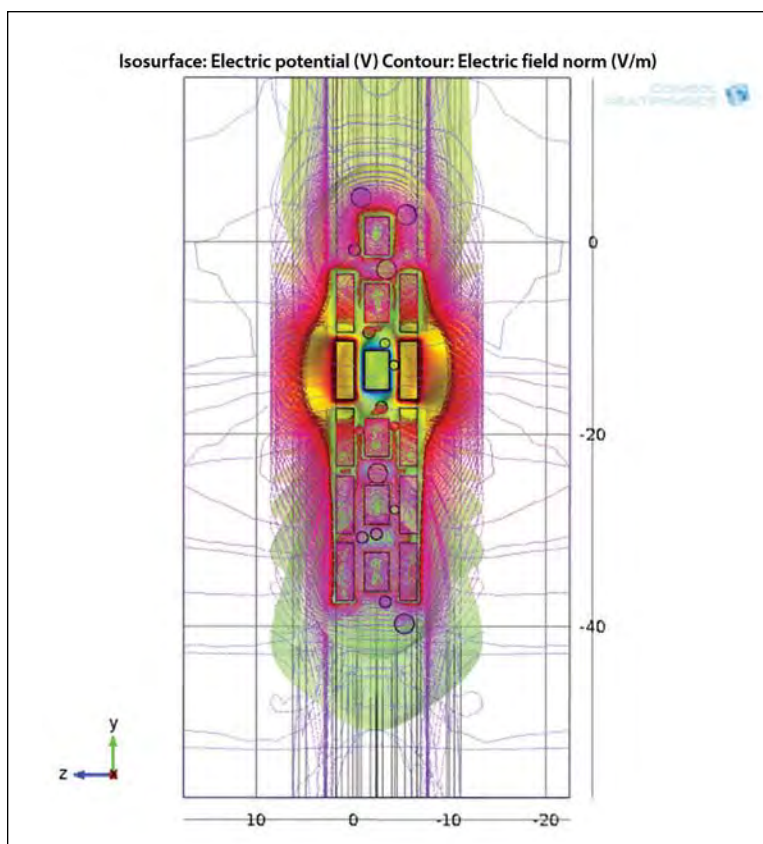

Figure 3. View of the stimulator array on the spinal cord with scars. Electric field isopotential and contour lines. Scar conductivity is initially set to that of tissue and anodes (red) properly shield cathode (blue) field from unwanted regions and toward center target.

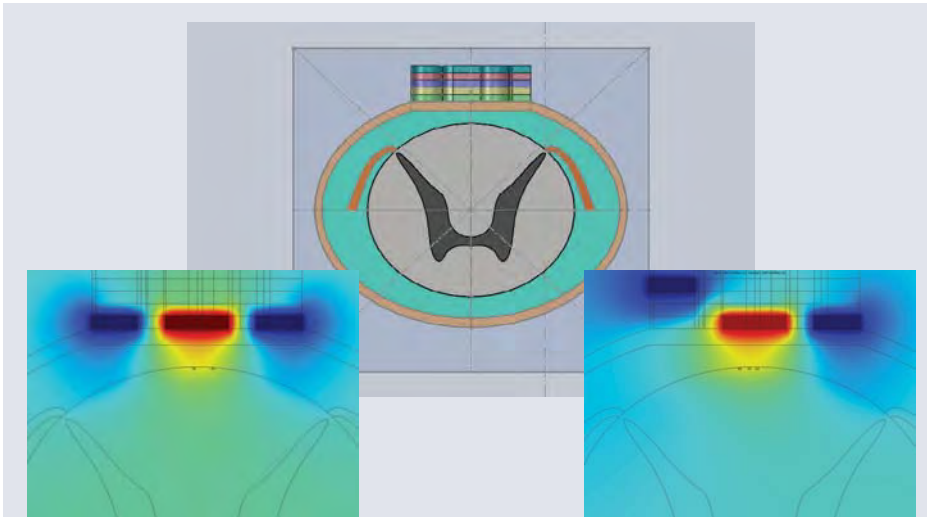

Figure 4. Slice plot and contour values of electric field projecting into the spinal cord.
Top: Cross section of electrode array on the spinal cord. Left: Control with no scar.
Right: Scar under left electrode reduces proper field symmetry. Contrary to expectation, scar can result in higher field values projecting into the spinal cord and too much stimulation.

outside the dura, which is tough and electrically resistive. The different materials have very different conductivities, that of the dura being low and that of the CSF being a couple of orders of magnitude higher.

To study the electrical environment, the team used COMSOL Multiphysics to create a finite element model of the gray and white matter in the cord, dura, cerebrospinal fluid, epidural tissue, scar tissue, and stimulator electrodes. The gradients of the system are affected by the relative conductivities of these different materials.

One reason that an accurate model is required is that the potential field can vary along the length of the spinal cord. It's possible that at one point, there isn't a high enough potential gradient to generate an activation potential at the neuron, while 0.5 mm or 1 mm away, you may have that critical gradient. These variations can occur for a number of different reasons: the electrode geometry is different; the material isn't uniform, for instance the dura itself might not be uniform across the cord; or there may be material such as scarring, which might make one area of the cord have a higher resistivity than another. There are also variations in the cerebrospinal fluid along different parts of the cord.

"Using SolidWorks and COMSOL together made it very easy to change the geometry with SolidWorks and study the

resulting changes in conductivities and permittivities with COMSOL," said Dr. Shils. "This means that the output of the simulation could be spatially added to a model that we have in-house of a neural network. This gives us a more accurate understanding of where the action potentials are occurring in the spinal cord and given some of the complexities, it was nice to be able to show that a little change in one place could really shift the energy gradient."

Carlson explained how the team uses simulation in their work. "We decided to do very sophisticated geometry, much more so than anything that had been done in the past. Not only 3D as opposed to 2D, but a much more accurate profile of the spinal cord. In the model, we set all the material parameters; we can play with those — mainly the conductivities, and then the physics — we change the voltages, pulse widths, and frequencies of the various electrodes. So for the scar study that the two doctors designed a year or so ago, we have an incredibly sophisticated geometry. There are 64 different pieces of scar and 64 electrode positions scattered on the surface of the spine and each of those is very easy to manipulate in COMSOL. Another great feature is that after we run the simulation, we perform a huge amount of post-

processing. With the graphic features in COMSOL, we can run all different kinds of filtering criteria and also export the data and perform further post-processing in tools dedicated for the purpose."

"The formation of scar tissue changes the playing field," said Dr. Arle. "Usually, the programmer is left not knowing what the scar looks like exactly, and trying to move the stimulation around to get the best treatment for the patient. Now, by adding only a little bit to the model, we can begin to see the distortion of the electrical fields caused by the scar formation." (Figure 4) The procedure is proving to be extremely effective in immediately relieving pain once the programming is on target.

"It's very important that you understand what you're doing with COMSOL Multiphysics," said Dr. Shils. "You have to understand the physics of what you're using — why you're using a certain model as opposed to another. The way you choose the meshing, which COMSOL allows you to do with great flexibility and precision, is a critical part of the analysis. You choose the proper elements and then figure out what the edges are supposed to be. The next step is to choose the appropriate equations, starting points, and meshing. Mesh quality is of particular importance, especially around the curves of the axons, which is where most of the activation is located. If mesh resolution is inadequate, we could miss the high points of the field and gradients."

What's Next?

By importing COMSOL data showing which nerve fibers fired into neural circuitry simulation software, the group intends to unravel how SCS produces relief from pain. Dr. Arle summed up his feelings about the project. "In biological systems in human anatomy and physiology systems, there's not a huge amount of work done on this kind of thing as opposed to more engineering-based projects. You really need to understand the anatomy, the physiology, and the neuroscience, and then ramp this up to understand the mathematics and the physics. People are beginning to realize that you need to take this approach to really understand what we're doing." ■

LAST CHANCE TO ENTER!

Entry deadline: June 30, 2012

It's YOUR

SAFETY & SECURITY



MACHINERY & EQUIPMENT



SUSTAINABLE TECHNOLOGIES

TRANSPORTATION



CONSUMER PRODUCTS

Calling all design engineers. It's up to you.

Share your new product ideas with the world, the possibilities are endless!

- Generate new jobs • Improve health • Increase sustainability • Boost security
- Make transportation safer • Advance electronics • Accelerate productivity

SPONSORED BY



MEDICAL
CATEGORY
SPONSOR



VALUE PLASTICS, INC.
A NORDSON COMPANY

PRIZE SPONSORS



3Dconnexion
A LOGITECH COMPANY



TURN

to

Create

the

Future

MEDICAL



ELECTRONICS

GRAND PRIZE: \$20,000 — plus global recognition and publicity to business and industry leaders who can help bring your idea to market.

NEW for 2012!

Add Video to
Your Entry

ACCEPTING INDIVIDUAL AND TEAM ENTRIES.

Get details at www.createthefuture2012.com

CATEGORIES

- Consumer Products
- Electronics
- Machinery & Equipment
- Medical
- Safety & Security
- Sustainable Technologies
- Transportation

Create THE Future

DESIGN CONTEST 2012





Simulation of Magnetic Flux Leakage Inspection

Salzgitter Mannesmann Forschung is using simulation to assess the behavior of steel pipes during electromagnetic inspection and improve the process of evaluating hidden defects.

BY JENNIFER HAND

Can we repair it or do we have to make it again? When a heavy steel pipe appears to have a crack, questions inevitably focus on how bad the flaw is. Safety is, of course, the paramount consideration; yet with thousands of Euros and project deadlines also potentially at stake, the most urgent requirement is for detailed information. For manufacturers of very large components, particularly those designed for operation under high pressure or high temperature, this is a familiar challenge.

“The ultimate goal is to simulate how different flaw geometries and sizes influence the measured signal so that we can correctly evaluate the form and size of a flaw.”

Quality test procedures are conducted throughout the entire steel manufacturing process and one of the most commonly used non-destructive testing (NDT) methods is magnetic flux leakage inspection, which involves magnetizing part of a steel tube. The inspection system con-



Figure 2. An inspection in operation: the yoke is embedded in plastic behind the orange box and as the pipe is rotating, the box moves along the pipe, 1 mm above the surface.

sidered here consists of a yoke, in the shape of a horseshoe, with a coil wrapped around each end. An alternate current of 3 kHz applied to the coils generates a thin magnetic field and any leakage between the two coils, measured by a hall probe, indicates that a discontinuity in the material is present, which might be a flaw. (Figures 1 & 2).

Although highly sensitive magnetic field sensors enable fairly easy detection of flaws close to the surface, accurate identification of their form, size and relevance depends on correct evaluation of the signals that are being measured.

Oliver Nemitz and Till Schmitte, researchers at Salzgitter Mannesmann Forschung (SZMF), which develop testing methods for the Salzgitter Group and also, as in this case, for the

external client Vallourec & Mannesmann, could see the potential to use FEM simulation in order to gain a clearer picture of flaw characteristics. “We are talking about pipes which might measure 500-600 mm in diameter, with a wall thickness of up to 50 mm and a length of 12 meters. The ultimate goal is to simulate how different flaw geometries and sizes influence the measured signal so that we can correctly evaluate the form and size of a flaw,” explains Nemitz. “This will also assist our understanding of false indications,” adds Schmitte.

The Model Inspection System

The simulation model was created using the AC/DC Module within COMSOL Multiphysics and featured a steel rectangle 10 mm high and 115 mm wide. Nemitz and Schmitte anticipated that calculation times would be long so they first built a 2D cross section model, in which the current through the coils is perpendicular to

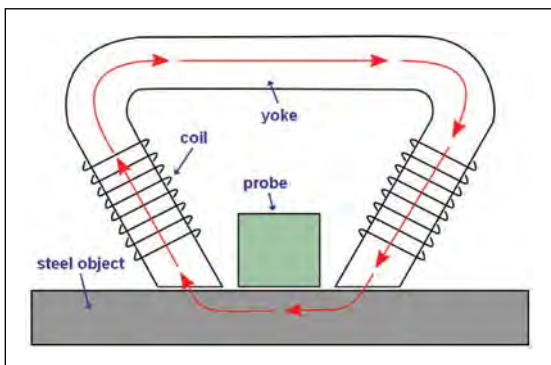

Figure 1. Sketch of the Magnetic Flux Leakage inspection system.



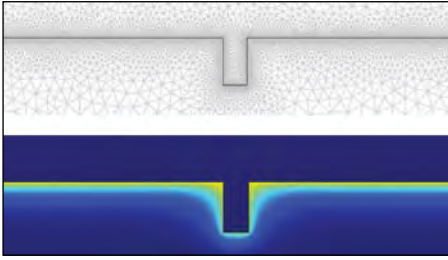

Figure 3. The mesh adequately resolves the thin magnetic layer at the top surface of the steel object.

the geometry plane. As the high frequency of the current produces a very thin magnetic field with a skin effect of 0.46 mm, a fine mesh is particularly important in the surface area. (Figure 3).

The geometry and position of the artificial flaw — a notch with a modifiable width, depth and angle, can be parameterized by a MATLAB® script. By looping over the notch position, the movement of the yoke as it scans along the steel object in the horizontal plane is simulated. Figure 4 shows the simulated signals associated with different notch widths.

Because the 2D system could only account for highly symmetric flaws, the next step was to set up a 3D model. A very dense mesh that would account for skin effect at the boundaries would, however, have resulted in about 20 million Degrees of Freedom (DOFs) and very long calculation times. In order to avoid this, the researchers used symmetries to reduce the size of the model by a quarter and then added some swept mesh at the boundaries. A calculation was done with

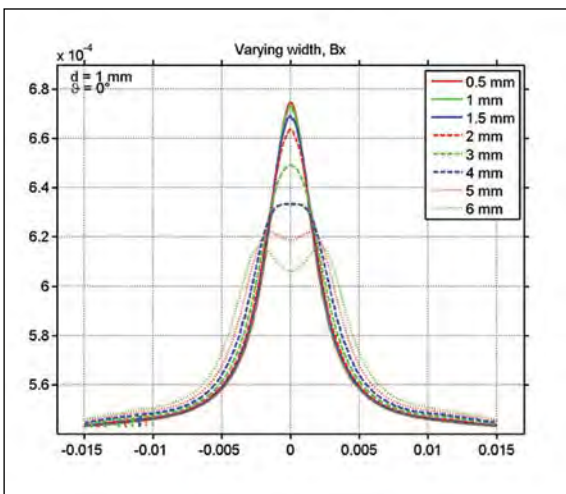

Figure 4. Resulting x-component of the magnetic flux density in different notch widths.

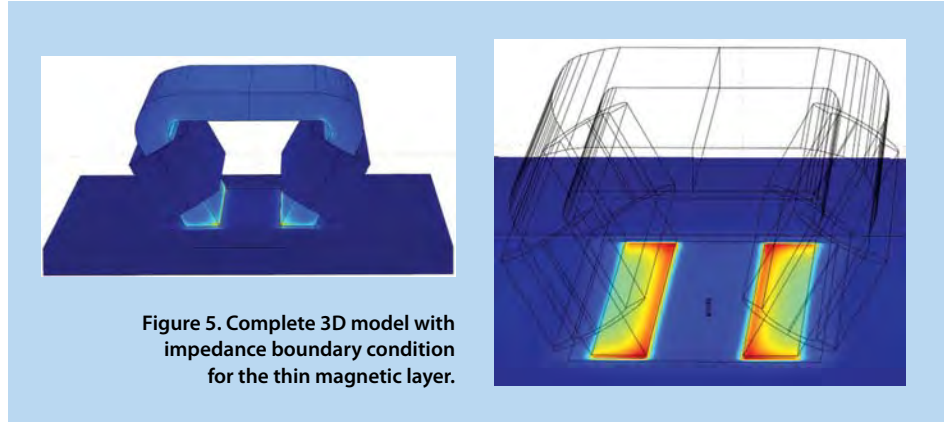

Figure 5. Complete 3D model with impedance boundary condition for the thin magnetic layer.

4.7 million DOFs but even with these modifications, it was only possible to investigate symmetric notches.

“We therefore decided to apply the impedance boundary condition to allow for the skin effect,” comments Nemitz. With this, the volume of the conductor does not have to be modeled; an approximation is valid if the thickness of the steel is more than 4 times the skin depth. “Given that the steel was 21 times thicker than the skin depth, this approach was valid; only the surface of the steel object had to be meshed and we reduced the model to 1.7 million DOFs. This included the entire 3D geometry and it was possible to define arbitrary notches.” (Figure 5)

To validate the model,

data from the simulation was compared with measured data from test pipes that contained notches of varying depth. The results showed a very good correlation quality of the signals (Figure 6).

Developing a Framework of Reference Results

“Our use of COMSOL Multiphysics allowed us to analyze signals from the MFL inspection system and understand their significance,” comments Nemitz. “In real life the detailed investigation

of the numerous defects we were able to analyze would have been time consuming and expensive — we would have had to create and test an extremely large number of test pipes. In the end, only one test pipe featuring different types of notches was measured and compared with the simulation data.”

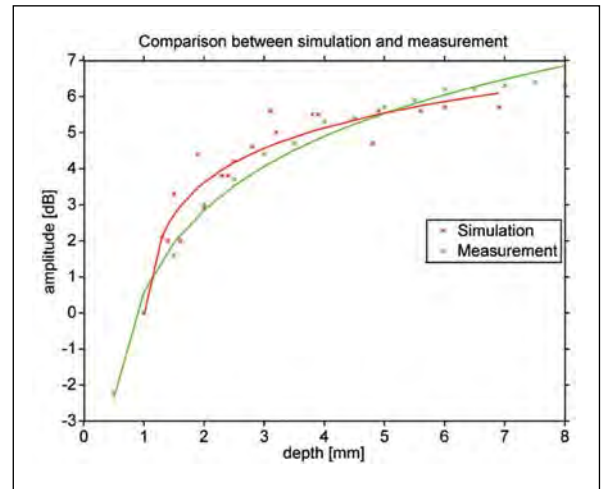

Figure 6. Comparison of simulation results with measured data. The two curves coincide quite well.

Schmitte concludes, “We are continuing to investigate our results so that we can deepen our understanding of the signals from different types of flaws and develop a sound reference framework for assessing their relevance. We are now band-pass filtering the signals to find out which signal parts can be blanked out and how this might affect the results. We also intend to address hysteresis effects based on non-linear material characteristics.” ■

RESEARCH PAPER

www.comsol.com/papers/8692/

MATLAB is a registered trademark of The MathWorks, Inc.





Surface Plasmon Resonance

BY SERGEI YUSHANOV, JEFFREY S. CROMPTON (CORRESPONDING AUTHOR), LUKE T. GRITTER, AND KYLE C. KOPPENHOEFER, ALTASIM TECHNOLOGIES

Surface plasmons are coherent electron oscillations that exist at the interface between any two materials where the real part of the dielectric function changes sign across the interface. Surface Plasmon Resonance (SPR) can be used to detect molecular adsorption on surfaces and consequently is of significance for technologies ranging from gene assays

penetrating tens of nanometers into a surface. The stimulated resonance oscillation of valence electrons reduces the reflected light intensity and produces SPR due to the resonance energy transfer between the evanescent wave and surface plasmons. The resonance conditions are influenced by the type and amount of material adsorbed onto the surface, thus allowing characterization of surface related phenomena.

considerations. However, it can also be described in terms of classical electromagnetic theory by considering electromagnetic wave reflection, transmission, and absorption for the multi-layer medium. In fact the excitation of plasmon resonance can only take place if the metal side of the interface is slightly lossy, i.e. when the imaginary part of the metal permittivity is a non-zero negative number.



The two Principals at AltaSim Technologies: Jeffrey Crompton and Kyle Koppenhoefer.

and DNA sensing, molecular adsorption and desorption on surfaces, surface controlled electrochemical reactions, and nano-scale optical and photonic devices.

SPR technology is based on the electromagnetic field component of incident light

SPR Models

Two typical configurations of plasmon excitation exist: the Kretschmann-Raether configuration, in which a thin metal film is sandwiched between a dielectric and air, and the Otto configuration, where an air gap exists between the dielectric and the metal. In both cases, the surface plasmon propagates along the metal/dielectric interface. The Kretschmann-Raether configuration is easier to fabricate but has a fixed dielectric gap that can affect the sensitivity of the measurement.

Full insight into surface plasmon resonance requires quantum mechanics

Magnetic Field Simulation

These two configurations for SPR have been analyzed using COMSOL Multiphysics to define the effect of the SPR on the electromagnetic field. It can be seen that the angle of resonance is sensitive to both the experimental configuration used and to the dielectric constant of the material adjacent to the metal surface. Using the analytical approaches demonstrated, the effect of different surface and experimental configurations on the SPR response can be defined, and has allowed the development of commercial technology for the measurement of surface contaminants and nano-scale photonic devices. ■

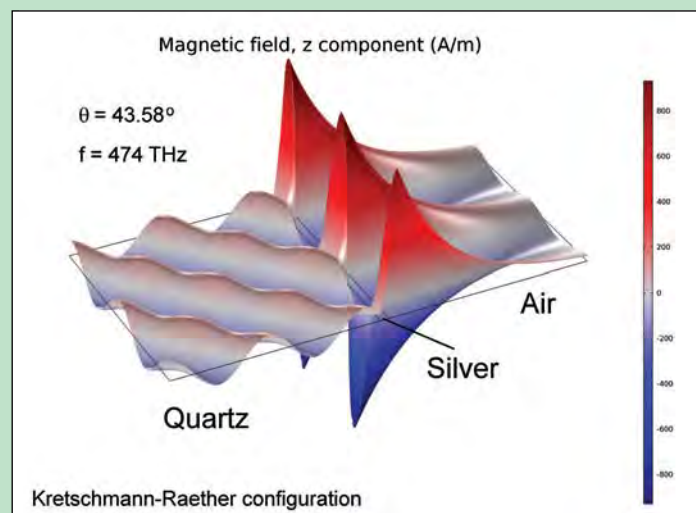

Figure 1. Magnetic field distribution at resonance condition for the Kretschmann-Raether configuration.

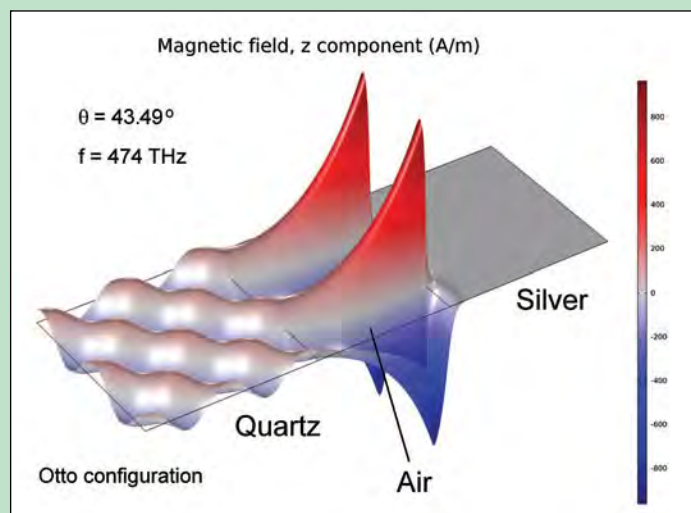

Figure 2. Magnetic field distribution at resonance condition for the Otto configuration.





Conjugate Heat Transfer

BY LUKE T. GRITTER, JEFFREY S. CROMPTON (CORRESPONDING AUTHOR), SERGEI YUSHANOV, AND KYLE C. KOPPENHOEFER, ALTASIM TECHNOLOGIES

The controlled transfer of heat from a component to its surroundings is critical for the operation of many industrial processes. For example, cooling of electronics components is needed to maintain safe operation and extend operating lifetime, while quenching of materials from elevated temperatures is often required to develop specific microstructural features that provide prescribed properties.

“The conjugate heat transfer problem can be analyzed using COMSOL Multiphysics and applied to conditions with and without phase transformation.”

The conjugate heat transfer problem can be analyzed using COMSOL Multiphysics and applied to conditions with and without phase transformation. For the simple case

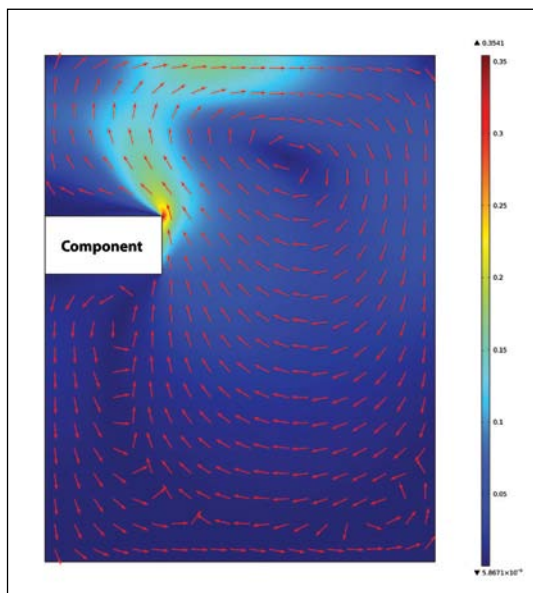

Figure 1. Fluid flow velocity vector resulting from bubbles evolving along the surface of a hot component during quenching.

when no phase transformation occurs in the coolant media, the rate of heat dissipation is a function of conduction and convection to the flowing fluid. The flow conditions and component geometry may give rise to turbulent flow that affects the heat dissipation over the surface.

Analysis of heat transfer under conditions where phase transformation occurs in the cooling fluid is more complex and must consider the range of

near-wall effects arising from film boiling, transition boiling, nucleate boiling and pure convection. The near-wall boiling processes that strongly influence heat transfer from the part to the quenching medium operate on a scale that is many orders of magnitude smaller than the component size. To accommodate these different scales, the complex 3D physics near the wall are analyzed here using sets of equations that are solved only on the walls of the component. Under these conditions, accurate analysis of the heat transfer can be obtained for the differential heat transfer rates into the gas or liquid phase and the effect of gas formation on the flow behavior (Figure 1).

In practice, commercial quenching during heat treatment includes forced fluid flow as well as fluid flow introduced by the phase transformation from liquid to gas. To provide a complete analysis of the flow pattern within a commercial quenching tank and the resulting thermal distribution in the specimen, the effect of the two

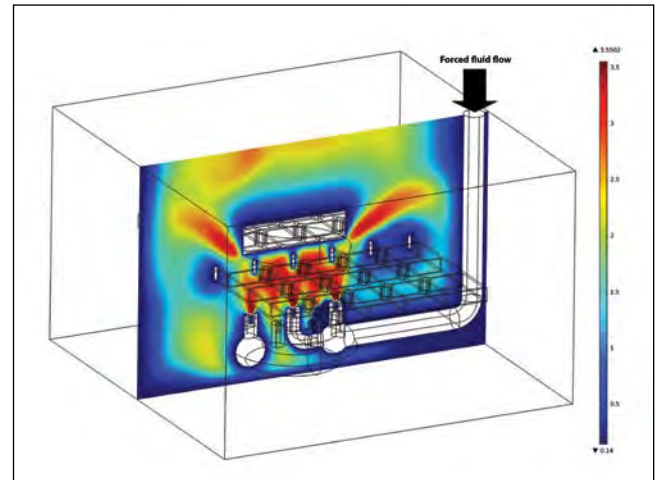

Figure 2. Results of variation of thermal conductivity developed under conditions of turbulent flow that combines multiphase flow, due to forced fluid flow, and flow due to buoyancy effects associated with bubble formation due to fluid boiling.

fluid flow components must be integrated. The analyses developed here used a multiphase flow model that included forced convection due to mechanical pumping, agitation caused by gas bubbles and vapor formation in complex geometries. The turbulent flow models were modified to account for the two-phase flow. Figure 2 shows the results of analyses of a commercial quench tank in which fluid is forced through nozzles and impinges on the bottom surface of a hot component lowered into the tank.

The results show the variation in the thermal conductivity due to the multiphase flow resulting from forced fluid flow and flow due to the liquid to gas phase transformation caused by the fluid boiling at the specimen surface. Using these analytical approaches the fluid flow conditions can be modified to produce a more regular distribution of heat extraction from the hot component. This allows the development of quench conditions in which an even temperature gradient can be maintained leading to more homogeneous microstructural variability within the final component shape and limited development of residual stresses in the component. ■



Empowering COMSOL speed and new

COMSOL Multiphysics version 4.3 is a major upgrade with powerful additions for electrical, mechanical, fluid, and chemical

New Modules

Nonlinear Structural Materials Module

Introduces a suite of nonlinear material models for Structural Mechanics and MEMS. Includes elastoplastic, viscoplastic, creep, and hyperelastic material models.

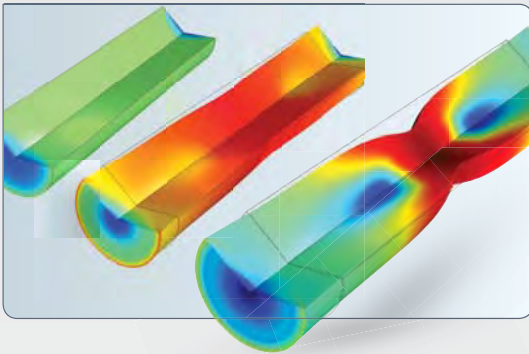

Corrosion Module

Corrosion and corrosion protection simulations based on electrochemical principles. This module lets you simulate galvanic, pitting, and crevice corrosion, and provides tool to help you design cathodic and anodic protection.

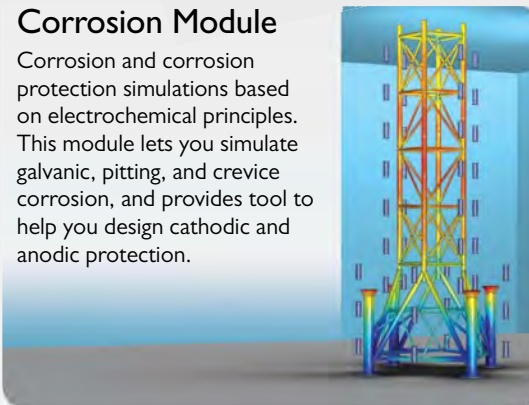

Pipe Flow Module

The Pipe Flow Module is used for simulations of fluid flow, heat and mass transfer, hydraulic transients, and acoustics in pipe and channel networks.

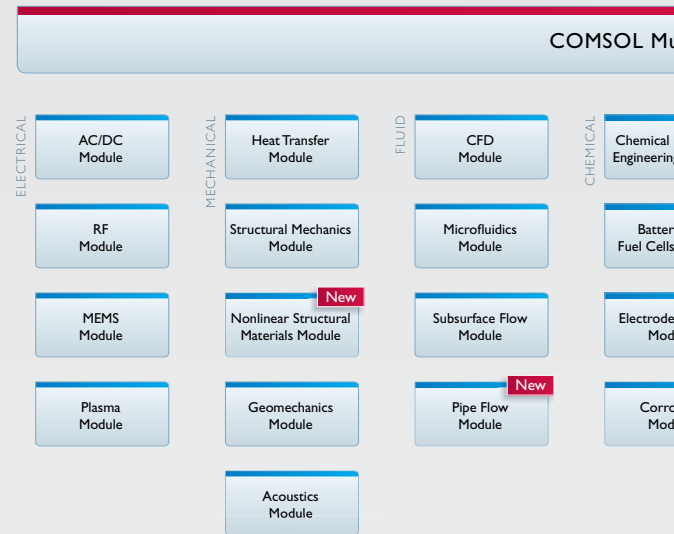
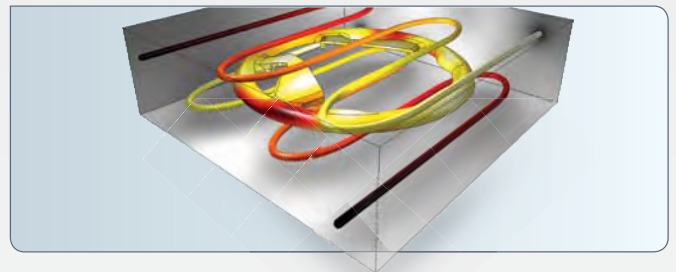

COMSOL users with more modeling tools.

of the leading multiphysics simulation environment with chemical simulations. For details visit www.comsol.com/4.3

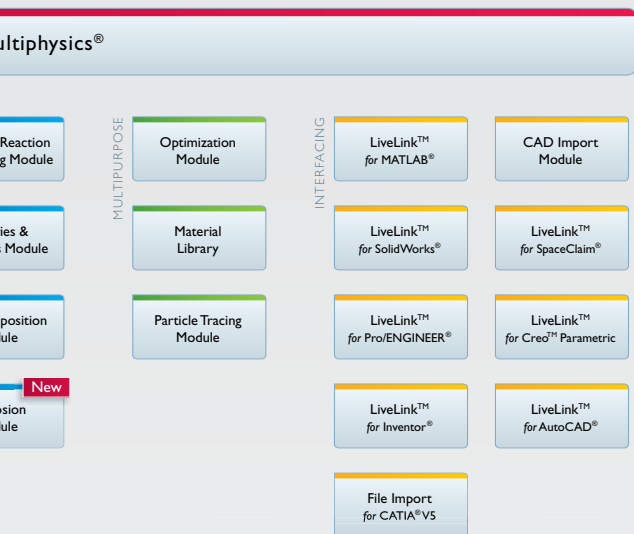

New in COMSOL Multiphysics®

Geometry, Mesh, and CAD Import

Meshing of imported CAD files is faster than ever. Users that have models with many surfaces, as well as those that use imported meshes, will immediately see the benefit of working with this release.

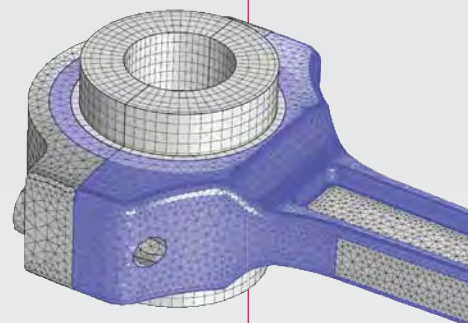

Mesh selections are now available for subdividing any imported mesh.

Cluster Sweep Speed Up

Cluster Sweep tool provides fast parallel computation of parameterized models with excellent scalability and usability.

Module Updates

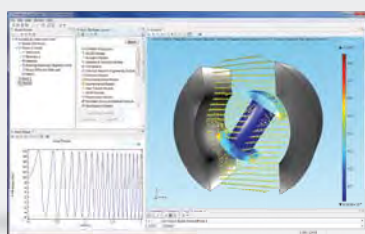

Electromagnetics

The AC/DC Module now supports modeling of rotating machinery for brushless motors and generators, brushed DC motors, and radial and axial flux machinery.

CFD

The CFD Module introduces easy-to-use turbulent mixing for mass transport simulations.

Particle Tracing

Automatic computation of particle trajectories with new built-in forces and particle-particle interaction.

RF

New fast far-field plots make it easy to visualize the asymptotic radiation pattern for RF and microwave antennas.

Heat Transfer

Easy setup of solar irradiation from latitude, longitude, date, and time.

Structural Mechanics

All-new nonlinear solver for mechanical contact and highly nonlinear simulations. The “double dog-leg” solver addresses a larger class of highly nonlinear simulations.

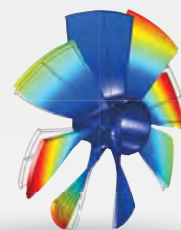



The Thermal Management of Li-ion Battery Packs

For both operational and safety reasons, it's crucial to keep the batteries in electric and hybrid vehicles within a certain temperature range. To find the optimal cooling method quickly and efficiently, researchers at Fiat are turning to modeling.

BY MICHELE GOSSO AND ANTONIO FIUMARA, FIAT RESEARCH CENTER

Given the long development cycle for vehicles, automobile manufacturers must plan their upcoming lines far in advance. And with growing emission regulations and the rising cost for gas, we can expect full electric and hybrid vehicles to become more attractive and grow in market share.

At the Fiat Research Center in Orbassano (near Turin), our group is focusing on the development of electric and hybrid vehicles using lithium and lead-acid batteries as well as supercapacitors. Fiat currently has several light trucks that run on electric drives, and the next application will be an electric version of the Fiat 500, which has been announced for the US market.

Cooling Multiple Battery Pouch Cells

We do not manufacture the individual lithium-ion battery pouch cells (Figure 1), but we are responsible for combining as many as 100 of them into battery packs that generate the 350V that is needed. Here, we must also provide sufficient cooling while keeping the packs as small and light as possible. Because the cells are wired in series, if one cell doesn't work well due to problems with heat, then it has a negative impact on the entire pack.

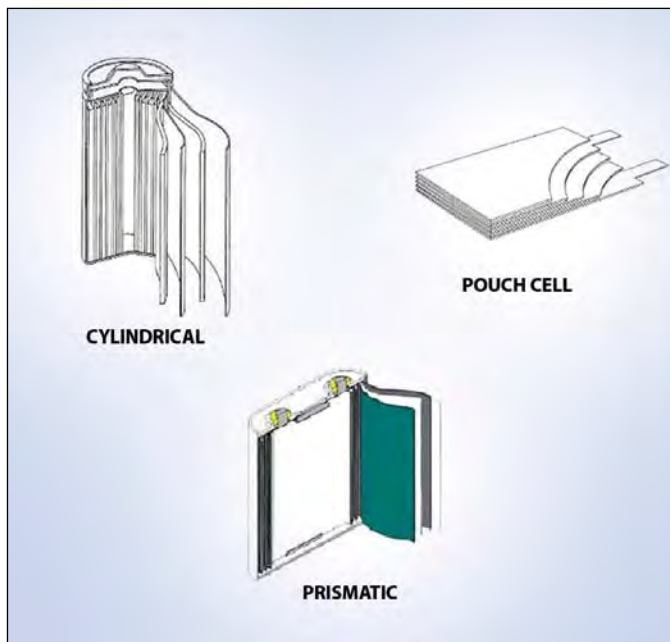

Figure 1. Three types of lithium-ion batteries. Fiat uses a series of 100 or so of the pouch cells to power their vehicles.

It is important that the maximum temperature differential among all the cells in a pack does not exceed 5 °C. Fur-

mal runaway, which can mean a jump directly to electrolyte emission, smoke, or in the worst case, fire.

In these batteries, heat is produced through both Joule heating and chemical reactions, which we determine from an expression dependent on the current density. In our designs we prefer convection air cooling and we are using COMSOL Multiphysics to study the surface distribution because of this.

Our model (Figure 2) divides each surface of the pouch cell into nine areas, which correspond to the thermocouples on the cell itself. We examine the temperature distribution at several charge/discharge rates and verify

that the model is consistent with reality, as measured by thermocouples and infrared heat cameras (Figure 3). Here,

“In our designs we prefer convection air cooling and we are using COMSOL Multiphysics to study the surface distribution because of this.”

ther, if the temperature of the pack as a whole is too low, it limits the charge you can extract from a pack; if it is too high, then you can run the risk of ther-

we found that the results were within 1 °C of the measurements (Figure 4).

With this information and confidence in the model, we can find hot spots on



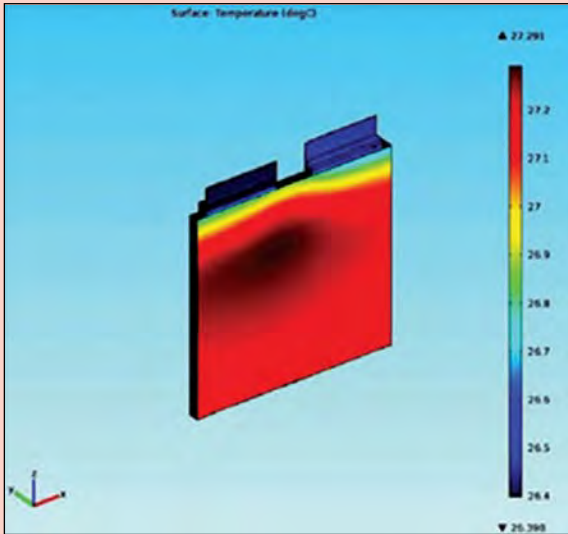

Figure 2. Surface heat of a lithium-ion battery pack — the uniform heat distribution is an important parameter.

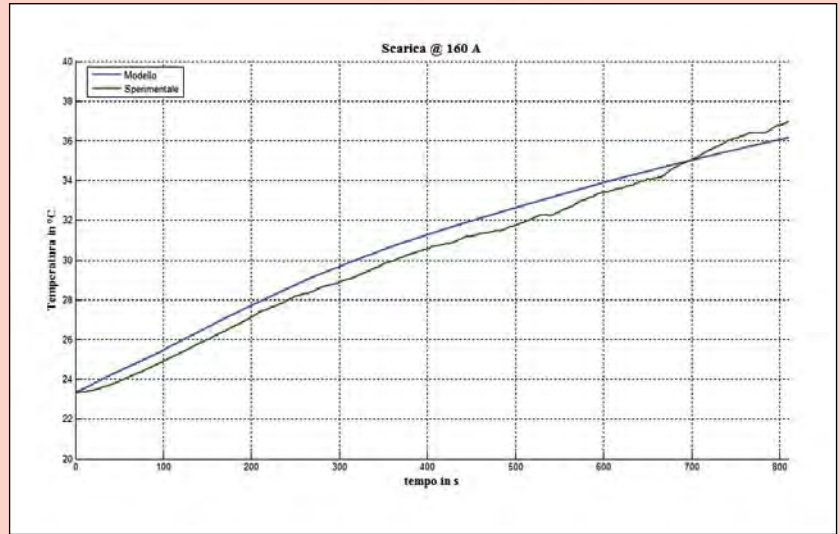

Figure 4. A comparison of model and experimental results at one of the thermocouples on the surface of the lithium cell. The results show a maximum difference of 1 °C between the two.

the cell and also investigate its internal temperature distribution. This provides invaluable information that cannot be achieved in other ways due to the difficulty of embedding thermocouples in battery pouches and attaining reliable results from them.

Smaller, Lighter Packs

With the knowledge we have gained from the model, we have been able to re-

duce the physical channels between the cells, which not only reduces space but also cuts weight because a smaller frame can be used. This makes it easier to insert the battery pack in a larger variety of vehicles, which is important because we are trying to adapt battery powertrains to vehicles already on the market.

In addition, we determined that a less powerful fan was required, which helped reduce costs. With the help of the

“With the help of the model, we were able to cut our design time by 70%.”

model, we were able to cut our design time by 70%; we estimate that instead of needing 1,000 hours for the design of a battery pack, we could cut it down to roughly 300 hours.

A future project will also look at the other extreme conditions for these battery packs, namely at temperatures below freezing. In these situations, it can be difficult to charge these types of batteries. But by leveraging the Joule heating effect and through innovative design, we believe that will also be able to solve this problem. ■

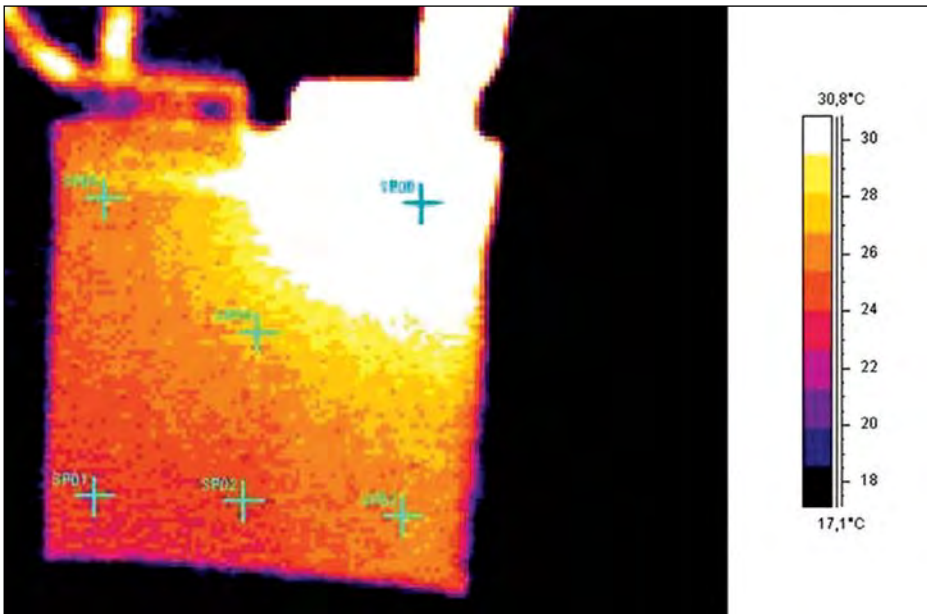

Figure 3. Result from using an infrared camera and thermocouples to measure the heat on the surface of a pouch cell.

About the Authors

Michele Gosso is a Senior Research Engineer at the Fiat Central Research Center in Orbassano, Italy, where he is in charge of the development of power for electric and hybrid vehicles. Antonio Fiumara is the group's coordinator.





Cluster Simulation of Refrigeration Systems

Using COMSOL Multiphysics on HPC clusters to develop environmentally friendly refrigeration systems for transportation of perishable goods.

BY STEPHEN CODYER AND MEHDI RAESSI (CORRESPONDING AUTHOR) OF THE DEPARTMENT OF MECHANICAL ENGINEERING AT THE UNIVERSITY OF MASSACHUSETTS DARTMOUTH, AND JESSICA CURRIE AND VLADIMIR GOLDSTEIN OF SUNWELL TECHNOLOGIES, INC.

Environmental and energy concerns related to fossil fuels have sparked interest in developing “green” and environmentally friendly systems that are both efficient and economically feasible. To that end, focusing on energy intensive industries that have higher environmental impact is the most effective approach. Among the top five energy-consuming industries is the food sector (Energy Information Administration), which, including food transportation, produces 20% of the total greenhouse gas emissions (Tassou et al.).

The refrigerated vehicles used for food transportation (e.g., refrigerated truck trailers) predominantly rely on conventional diesel engine driven refrigeration units. In addition to the low efficiency of these refrigeration units, their greenhouse gas emissions are about 40% of the emissions from the refrigerated vehicle’s engine itself (Tassou et al., 2009). The main reason for the relatively low efficiency of transport refrigeration systems, compared to the stationary ones, is the wide range of operating conditions as well as space and weight constraints. Recently, strict regulations on energy consumption and emissions in addition to rising demand in the food market have put enormous pressure on the food industry, especially the food transport sector, to reduce emissions and environmental footprints. That would require developing refrigerated systems that rely on clean energy technologies and are fundamentally different than the conventional diesel-engine-driven refrigeration systems.

Sunwell Technologies Inc., which is the global leader in variable state slurry ice (Deepchill™) production, storage and distribution, has developed refrigerated units that solely rely on Deepchill™ thermo batteries. The size of a refrigerated unit can vary between a small box and the size of a truck trailer. The Deep-

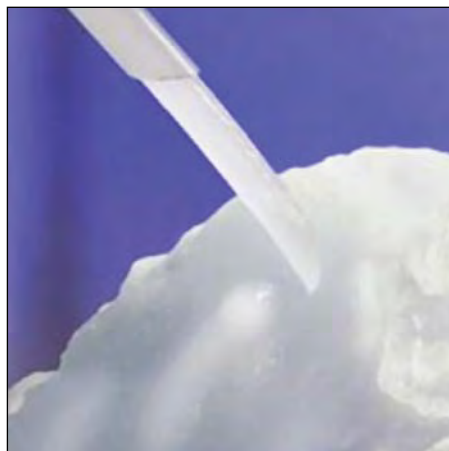

Deepchill™ cooling fluid is 100% recyclable and environmentally friendly.

chill™ thermo batteries are rechargeable and are designed to maintain the refrigerated unit at the desired temperature for 48 hours. The Deepchill is produced and stored in highly-efficient facilities (charging stations) that run on off-peak electricity, and therefore, have minimum environmental impact. To reduce the environmental impact even further, the electricity could be supplied to these fa-

cilities by renewable resources; for example, wind or solar. Furthermore, the cooling fluid (Deepchill™) is 100% recyclable and environmentally friendly, because it consists of water and salts, which are benign to the environment.

Heat and Fluid Simulations

The Computational Multiphase Flows group at UMass Dartmouth has been using COMSOL Multiphysics to provide simulation support to Sunwell’s experimental efforts in developing the Deepchill™ thermo battery technology. Computational simulations are a useful and cost-effective means to complement and leverage experiments, which are typically difficult to perform due to the large size of the refrigerated systems, and are associated with high costs and long completion times, especially at the early design stages. COMSOL Multiphysics was used to perform simulations of heat transfer and fluid dynamics in the refrigerated system. Running COMSOL Multiphysics on the UMass Dartmouth’s High Performance Computing (HPC) cluster enables the use of three-dimensional (3D) models with fine meshes and excellent completion time that will ultimately increase the accuracy and enhance our understanding of the results.

COMSOL Multiphysics models, varying from 2D-axisymmetric to full 3D,

are utilized to investigate specific design criteria, including the thermal load on the system, average and maximum temperatures of specific domains, insulation performance and natural convection, all of which is measurable either via probes

“Running COMSOL Multiphysics on the UMass Dartmouth’s High Performance Computing cluster enables the use of three-dimensional models with fine meshes and excellent completion time that will ultimately increase the accuracy and enhance our understanding of the results.”



during the solution process and/or afterwards in the results section.

HPC Cluster Simulations

Large-scale simulations with fine meshes and thus high memory requirements are ported to the UMass Dartmouth's HPC cluster, where COMSOL's direct solver MUMPS with distributed memory is used. Typical HPC cluster simulations utilize 1 to 3 nodes with 8 processor cores each and complete in half a day to a week, depending on the complexity of the underlying physics, e.g. coupled fluid dynamics and heat transfer, and the length of simulation time, which can go up to 48 hours.

A majority of the HPC cluster simulations are run through the terminal by creating a clustersimple batch. For example, a typical command would resemble the following format:

```
comsol -clustersimple batch -nn [A]
[-mpirsh ssh] -inputfile [file.mph] -outputfile [file_results.mph]
```

Where *A* is the number of threads to use, *-mpirsh* informs the system of which network system to use, and *file.mph* and *file_results.mph* are the COMSOL Multiphysics model file and eventual results file, respectively. The current progress may be reported to a logfile via the *-batchlog [logfile.log]* command, and is used at the end of the foregoing command line. The current iteration number, time step, etc. (same as the log tab in the COMSOL Multiphysics GUI) are reported.

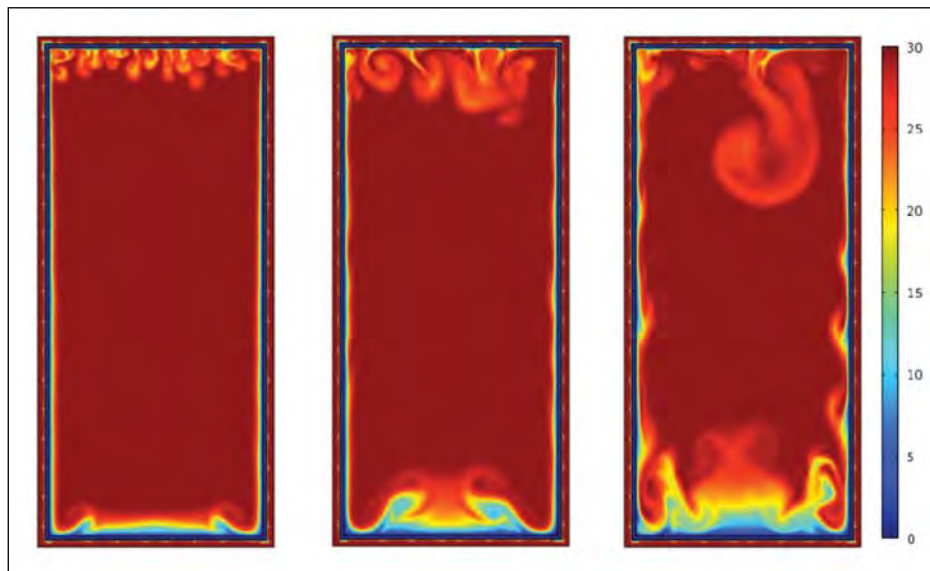

Figure 1. Natural convection and temperature distribution during cooling of a refrigeration unit by using the Deepchill™ thermo batteries (left to right: $t = 5, 8$ and 12 seconds).

In situations where probes are required to read live data as the simulation is running, interactive sessions from a workstation to the HPC cluster are utilized. Similar parallel computing parameters, for example, number of threads, are entered in the *Study > Job Configurations > Cluster Computing* tab. Ultimately, this provides the same GUI as workstation simulations, but with the computational power of a HPC cluster.

Results

Figure 1 presents a two-dimensional COMSOL Multiphysics simulation of a refrigerated unit that is cooled by the Deepchill™ thermo batteries. The unit is initially at $30\text{ }^{\circ}\text{C}$ and the thermo batter-

ies are at $0\text{ }^{\circ}\text{C}$. The simulation captures the Rayleigh-Taylor instabilities seen on the top surface. The instabilities occur because a layer of cold, heavy air is sitting on warm lighter air, which represents a configuration that is physically unstable. As can be seen, the instabilities grow and merge (middle image), and form large mushroom-type fluid structures (right image). The natural convection of air is also clearly seen on the sidewalls.

The COMSOL Multiphysics simulations in this project were performed on the UMass Dartmouth's Scientific Computing Group HPC cluster. The HPC cluster consists of 72 nodes, each with two Intel Xeon (quad-core) E5620 2.4 GHz processors and 24 GB of DDR3 ECC 1333 MHz RAM. There are 60 Nvidia Tesla M2050 GPUs on the HPC cluster. The nodes are connected via a Mellanox ConnectX-2 VPI Single-port QSFP QDR IB/10GbE PCIE 2.0 HCA with a 10m IBM Optical QDR InfiniBand QSFP Cable, and run 64-bit Red Hat Enterprise Linux distribution version 5.5. COMSOL Multiphysics version 4.2 is utilized. ■

REFERENCES

- Energy Information Administration. "Annual Energy Outlook." Department of Energy, 2010.
- Tassou et al. "Food transport refrigeration — Approaches to reduce energy consumption." *Applied Thermal Engineering* (2009): 1467-1477.



The refrigeration systems study team (from left): Mehdi Raessi, Stephen Codyer, Jessica Currie, and Vladimir Goldstein.



Optimized Heating Process with Uniform Coating

Optimizing the Ruukki Metals color coating process increases product throughput and helps achieve higher and uniform quality.

BY MIKA JUDIN, RUUKKI METALS OY

When coating rolled metal with paint, it's important that the coating be applied such that it's not discolored or damaged through; for example, overheating or even boiling, which can cause pitting. The process must also result in an end product with good weather resistance and a long service life. Another goal is to eliminate waste and increase process throughput and production rate. With these aspects in mind, I recently created a model in COMSOL Multiphysics to as-

"I recently created a model in COMSOL Multiphysics to assist in the optimal running of the heating/paint-drying oven for surface-coated roofing, façade, and panel materials."

sist in the optimal running of the heating/paint-drying oven for surface-coated roofing, façade, and panel materials.

Rautaruukki Oyj supplies metal-based components and systems to the construction and mechanical engineering industries. It has operations in approximately 30 countries, and annual sales in 2011 were almost 3 billion Euros. At one of the divisions, Ruukki Metals Oy in Hämeenlinna, we manufacture weather-resistant steel raw material for roofing and other building parts as well as for the domestic appliance industry. Other Ruukki Metals products include wear-resistant steels for

applications such as excavator buckets, cutting edges for earthmoving machines, wearing parts for mining machines, concrete mixers and wood-processing machines. In addition, our high-strength steels are used in various vehicles, transportation equipment, tipper bodies, lifting equipment booms and containers.

Coating Roofing Sheet Metal

One application for our products is the manufacture of sheet metal for roofing, and here building contractors and owners are particularly concerned about having the proper color (shade, gloss, reproducibility) as well as a long-lasting product. Our color-coating process for roofing sheet metal takes place on a system that is equipped with two ovens with several oven zones (Figure 1). Currently, steel sheets move through this at a rate of 45 to 90 meters/minute. The metal strip entering the process already has a coating of a zinc alloy on top of which the paint is applied.

The settings for the oven — temperature at various stages and the speed of the material through the oven — vary considerably depending on the base material, its composition and thickness, and the paint (Figure 2). We had been searching for a tool to help us quickly determine and enter the proper settings. Earlier, I created a theoretical model based on a differential equation to calculate the thermal curves

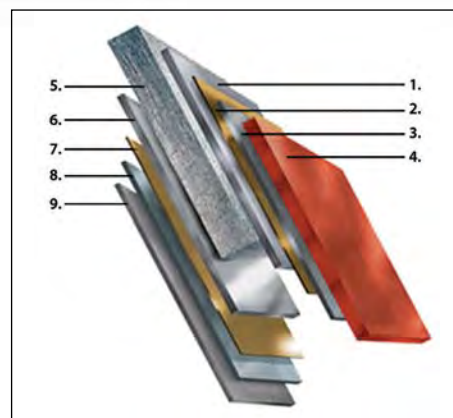

Figure 2. The layers in a typical roofing sheet: 1. Zinc layer 2. Passivation layer 3. Primer 4. Coating 5. Steel sheet 6. Zinc layer 7. Passivation layer 8. Primer 9. Protective paint coat.

during the drying process. However, it could not properly estimate internal heat transfer, and only through separate calculations could I estimate the time it takes to achieve a steady temperature difference in the oven.

I first used COMSOL Multiphysics to determine the heat conductivity of the paint during the drying process in a 3D model. I then used it to model the whole oven drying process. From a geometry standpoint it's a simple model, but even so, the physics in the multiple layers we are investigating can become quite complex because we are modeling heat transfer, a liquid-to-vapor phase change (moisture being driven out) and a liquid-to-solid phase change (paint pigments turning to a solid, and this without any change in color or other properties). To find the process settings, the model calculates the heat distribution on both sides of the zinc-coated steel as a function of time; we want to know the temperature distribution of the metal strip that is coated with several

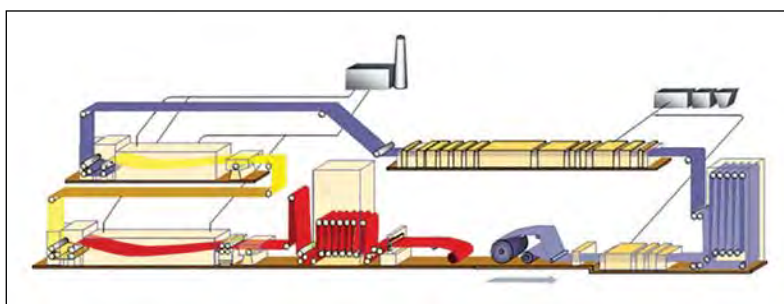

Figure 1. Outline depiction of the color coating process. The coating is applied where the strip is a yellow color, while the oven zones are where the strip is a red color.

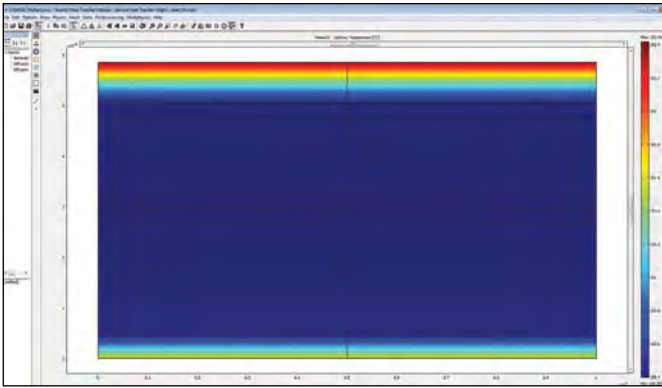

Figure 3. Temperature profile over the thickness of the material after 10 s of drying.

layers of paint (Figure 3). With the model, we are also trying to discover why some coatings are sensitive to boiling, yellowing and other defects. In addition, we can identify and confirm new critical parameters in the stoving process.

Making Life Easy for Operators

When the coating process is running, operators must change these settings for each new material or coating, which happens frequently. Changing the dimensions and other material properties such as density, solvent properties and diffusivity parameters of the paint can be time-consuming and prone to error, where at least 43 input values must be included. We need these settings for the COMSOL model and use MATLAB® to create a user interface for the COMSOL simulation (Figure 4).

The operators can use entry boxes and pull-down menus in the user interface

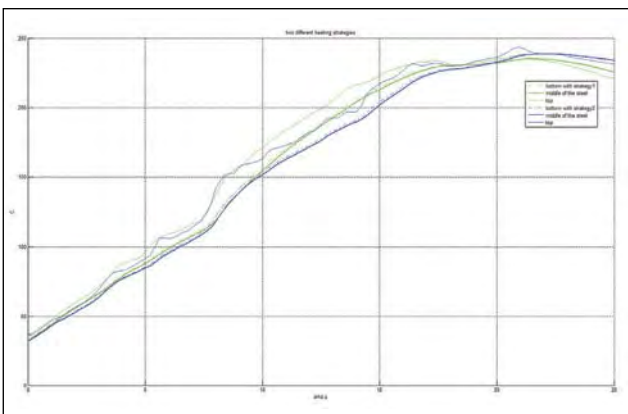

Figure 4. Temperature (in °C) in the middle (thick lines), top (thin lines) and bottom (dashed lines) surfaces of the material over time (in seconds) as calculated using COMSOL Multiphysics. The green lines were calculated using normal process inputs, while the blue lines were calculated using adjusted inputs.

“We are now investigating the possibility to automate the process and integrate it directly with the process machinery, without the need for an operator to enter them manually.”

to describe the type of materials, their thicknesses and other inputs specified in the production planning. The application

then searches a centralized database that contains the properties of these materials and then inserts them in the model. After the model runs, it displays the results in a form that shows the operators exactly which parameters must be changed and by what values.

With the model, it is possible to determine critical parameters in the stoving process such as the maximum possible heating rate, Biot number (which compares heat conduction inside a body to heat convection away from its surface) and the maximum temperature differential between the strip and the steel. We can estimate the performance of systems with varying layer thicknesses, specific heat, heat conductivity, density and solvent parameters. Analyses make it possible to fine-tune oven setups and provide feedback to paint manufacturers, which sometimes have to modify the properties of their paint.

With the model, I can calculate the temperature distribution (from the top to the bottom) of the coated material

in 0.1- to 0.2-second intervals. It can also determine the temperature distribution of any layer, even those with thicknesses of just several micrometers. In addition, it's possible to test new coatings in the model and compare results to previous coatings to determine if it is possible to run the process without any defects.

Uniformly High Quality

From an operating standpoint, we also get a number of benefits. We run the machines in multiple shifts, and different operators have their own preferences of how to best run the machines. As a result, there was an interest in achieving a higher degree of product uniformity and assuring the same high quality over each shift. With this software, all the operators use the same optimized set of parameters for each grade, which leads to repeatability and high quality. Further, it takes less time to change the process for a new grade, so more product can be produced. There are also energy savings because we optimize use of the power-hungry ovens.

The optimization of the process can be taken yet a step further. We are now investigating the possibility to automate the process and integrate it directly with the process machinery, without the need for an operator to enter them manually. ■

MATLAB is a registered trademark of The MathWorks, Inc.

About the Author

Mika Judin has been employed with Rautaruukki Oyj since 1999, and his primary task is to tune existing mathematical models and create new ones for a variety of lines including cold rolling mills, tempering mills and galvanizing lines. He has a degree from the University of Oulu's Department of Process Engineering and also a MSc in Chemical Engineering.



Simulation-Based Engineering Fosters Innovation and Invention

Simulation-based engineering design helped generate a first physical prototype of a micro-channel heat exchanger that worked largely as expected.

BY CATHLEEN LAMBERTSON, CONTRIBUTING EDITOR, TECH BRIEFS MEDIA GROUP

Founded in 2000, Intellectual Ventures (IV, Bellevue, WA) is a global leader in the business of invention, boasting one of the largest intellectual property portfolios in the world. IV has accomplished this by building, buying, and collaborating to create inventions and then supplying those inventions to companies through various licensing and partnering programs. They invest both expertise and capital in the process of invention in diverse technology areas including healthcare, medical devices, semiconductors, information technology, software, financial services, and manufacturing. In 2008, IV launched an invention/prototype laboratory to support the company's mission of energizing and streamlining an invention economy that will drive innovation around the world.

Intellectual Ventures Laboratory (IVL) employs broad interdisciplinary teams of physicists, engineers, chemists, biologists, and physicians tasked with discovering, inventing, and developing advanced technology solutions in a variety of fields. According to Ozgur E. Yildirim, Ph.D., Engineering Program Manager at IVL, simulation and analysis have been one of the cornerstones of research and

development (R&D) at the lab from the beginning. "The lab and the extended R&D we support under IV is highly multidisciplinary. The types of simulations range from very large epidemiological models, neutronics models for nuclear reactors, and sophisticated continuum models for electromagnetics, structural, ther-

mal, and fluidics analysis, and transport phenomena in general," said Dr. Yildirim.

Simulation at IVL

Much of the progress at IVL relies on modeling and simulation simply because experiments can take a long time to accomplish. This is especially true in areas such as epidemiological modeling or neutronics. Further, modeling and simulation can provide different and unique insights that would not be easily possible by experimentation. Additionally, in more traditional hardware R&D, researchers at IVL use modeling and analysis very

closely and iteratively with prototyping and direct experimentation to guide the design directions, interpret experimental observations, reduce cycle times, and in general to maximize understanding.

Almost all of the projects at IVL use some type of modeling and analysis and, according to Dr. Yildirim, a significant

"The lab and the extended R&D we support under IV is highly multidisciplinary."

portion of them lend themselves to finite element analysis (FEA). This is why COMSOL Multiphysics software is used extensively at IVL. For example, COMSOL was used on such projects as the TerraPower nuclear reactor conceptual design, IV's passive cold storage device for vaccine distribution, the "Photonic Fence" that uses lasers for malaria vector control, and a new beam-steering metamaterials satellite antenna. COMSOL is even used in IVL's state-of-the-art culinary sciences lab. A fairly new area of study, culinary physics is the convergence of physics and mathematical analysis with food science.

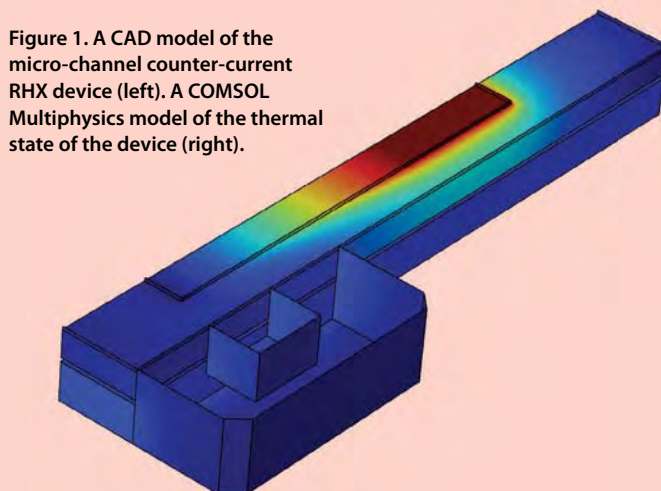
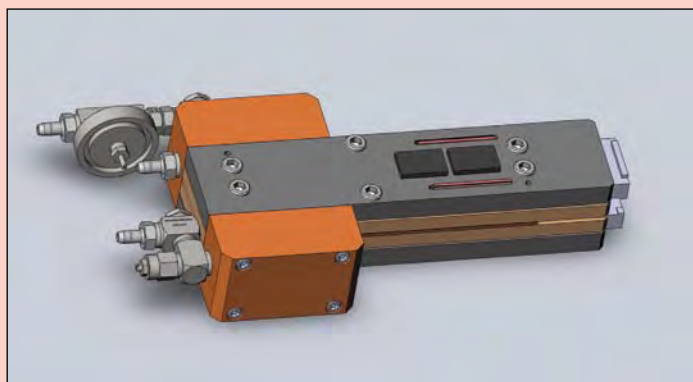

Figure 1. A CAD model of the micro-channel counter-current RHX device (left). A COMSOL Multiphysics model of the thermal state of the device (right).

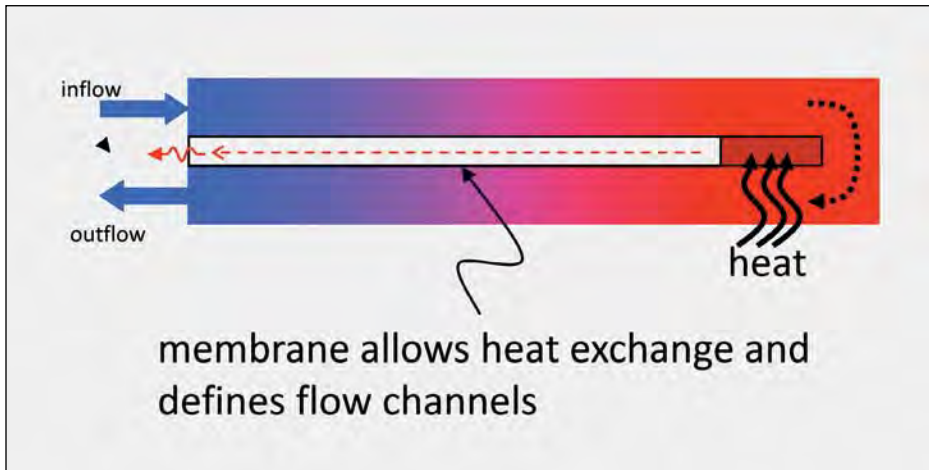

Figure 2. A schematic representation of a unit flow loop in the micro-channel counter-current RHX device. A small amount of added heat is enough to maintain the temperature profile in the device once steady state is reached, thanks to very high regenerative efficiency.

This large project recently culminated in a very untraditional “cookbook” called the *Modernist Cuisine*.

Recently, Dr. Yildirim and his team used COMSOL Multiphysics to model the design and development of a novel micro-channel counter-current regenerative heat exchanger (RHX) to thermally process a liquid stream with exceptionally high heat-recapture efficiency (Figure 1). “COMSOL is a state-of-the-art computational tool that gives a lot of visibility and control into the kind of physics being simulated. It is unique in that it allows the user to be a scientist, mathematician, and engineer, all at the same time, going way beyond a black-box modeling tool,” stated Dr. Yildirim.

The RHX Explained

An RHX is a type of heat exchanger in which the same fluid is both the cooling fluid and the cooled fluid, meaning the hot fluid leaving the system gives up its heat to “regenerate” (heat up) the fluid returning to the system (Figure 2). RHXs are usually found in high-temperature systems where a portion of the system’s fluid is removed from the main process and then returned in the opposite direction for further processing. Because the fluid removed from the main process contains energy (heat), the heat from the

fluid leaving the main system is used to regenerate (reheat) the returning fluid instead of being rejected to an external cooling medium. And since most of the heat energy is reclaimed, the process gives a considerable net savings in energy. For example, a typical RHX can have a thermal efficiency in the vicinity of 80-90%, transferring almost all the relative heat energy from one flow direction to the other.

A wide variety of fluid-handling applications involve RHX operations. According to Dr. Yildirim, RHXs may be useful in liquid food or pharmaceutical processing in order to thermally inactivate microorganisms or enzymes, or in achieving controlled temperature cycling for bio-chemical reactions as with flow-based polymerase chain reaction systems.

“Micro” Modeling

Whereas “large” RHX systems have been in use for a long time, their smaller micro-channel counterparts are a more recent area of interest. “Large RHX systems are almost always found integrated as part of industrial plants and are capital intensive. Micro-channel RHX accomplish the same function at a much smaller

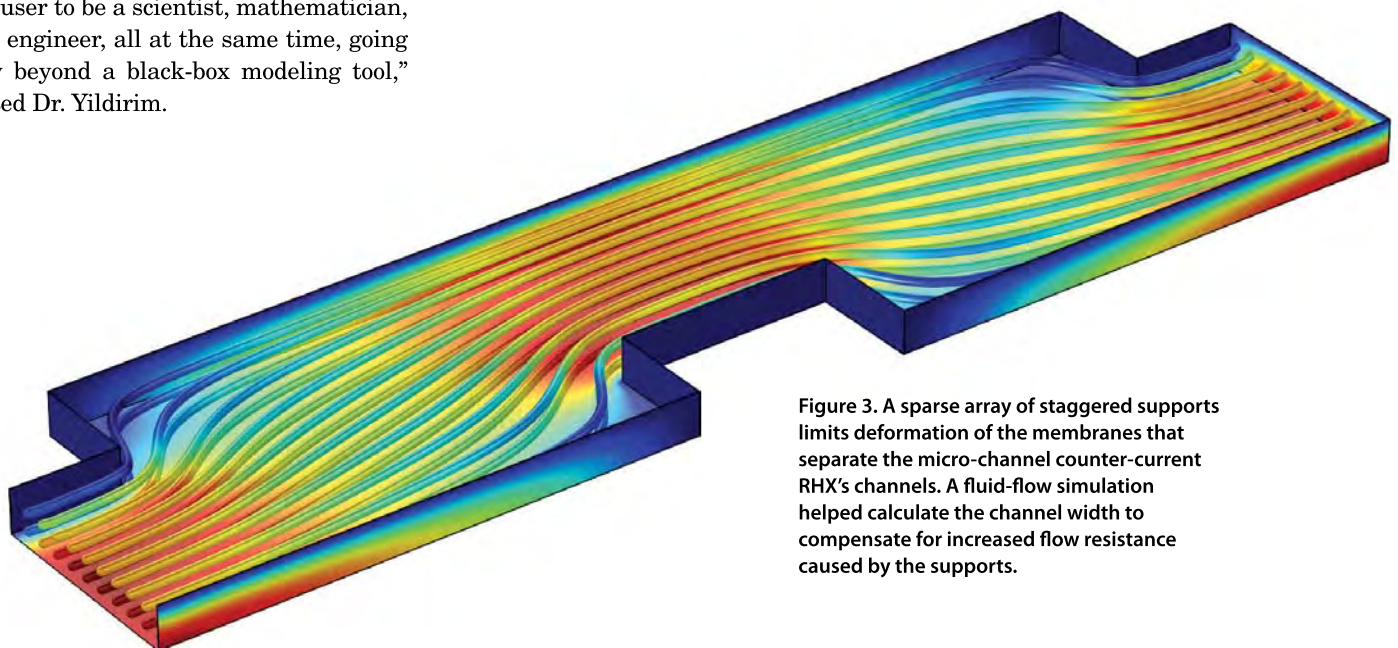

Figure 3. A sparse array of staggered supports limits deformation of the membranes that separate the micro-channel counter-current RHX’s channels. A fluid-flow simulation helped calculate the channel width to compensate for increased flow resistance caused by the supports.

scale, thereby opening up areas for potential new applications where the device footprint and/or process stream quantities are small,” explained Dr. Yildirim. For example, the micro-channel RHX devices would be useful in modular applications where small quantities of liquid need to be treated without having access to a large infrastructure and/or energy supply. In addition, micro-channel RHX is easily scalable in a way that large systems may not be. “You can think of it as a small miniaturized factory that requires much less infrastructure — the task can be performed on a benchtop or out in the field,” he added.

The novel micro-channel counter-current flow RHX system developed by the IVL team is designed to thermally process a liquid stream with exceptionally high heat-recapture efficiency. “Since micro-channel RHXs are a less well-studied area of application, one cannot necessarily rely on the large amount of engineering knowledge base that has been painstakingly developed over time and is available when it comes to traditional heat exchangers; rather more groundwork needs to be re-done from first principles. Fortunately, COMSOL makes this easy and fun,” said Dr. Yildirim.

After laying out the basic device architecture, COMSOL was used as the main analysis tool to investigate the effect of primary design variables on the device



Dr. Ozgur Yildirim (left) and Dr. Zihong Guo — core members of the novel micro-channel counter-current RHX team — with a prototype of the device.

device in detail (Figure 3) and to help interpret the experimental results after the first physical prototype was built and tested. “This is one of COMSOL’s biggest strengths — the multiphysics, and unlimited and unrestricted physics couplings that are possible,” stated Dr. Yildirim.

In addition, when it comes to making a physical prototype, challenges such as selecting the correct material set to withstand the inherent temperatures and pressures, or choosing prototyping processes to assemble a functional de-

The Advantage

Utilizing a simulation-based engineering design approach resulted in the first physical prototype working largely as expected: The prototype design of the micro-channel RHX system was shown to be capable of thermally treating a water stream by ramping its temperature from room temperature to about ~ 130 °C under pressure to prevent boiling, and back to ambient again with close to 98% regenerative energy recapture in a compact, very low-energy thermal treatment device. The concept was proved quickly and the number of subsequent design iterations was minimized. “During this project, I took full advantage of COMSOL’s ability to represent parts of the physics analytically rather than trying to solve everything blindly starting from the partial differential equations and focus only on the part of the physics I wanted to isolate and investigate computationally. This resulted in significant speed-ups and allowed for very nimble use of modeling and analysis,” explained Dr. Yildirim. “Furthermore, the ability to couple different kinds of physics with COMSOL came in handy as well.” ■

RESEARCH PAPER

www.comsol.com/papers/10786/

“This is one of COMSOL’s biggest strengths — the multiphysics, and unlimited and unrestricted physics couplings that are possible.”

performance. Dr. Yildirim explained that the most important performance attributes of interest were the heat exchange (regenerative) efficiency, i.e., the fraction of heat energy re-captured from the hot stream after it is first transferred into it, which plays into the device power requirement; and the pressure drop/flow rate relationship, which plays into the pumping requirements. COMSOL was also used to explore the structural stability of the

vice can arise. “Thus not only have we had to study the basic physics using COMSOL, we have also had to do significant amount of hardware and assembly process work to come up with a viable way to make functioning prototypes. This involved exploration of adhesives, thermal vias, as well as photolithography techniques. We used COMSOL in a very integrated manner with prototyping activities,” said Dr. Yildirim.

Learn more & request
a FREE TRIAL at
spaceclaim.com/comsol

CAD Slowing You Down?

Do CAD problems slow you down
when preparing models for CAE analysis?

With SpaceClaim Engineer, you can focus
on the analysis rather than preparing the model.

SpaceClaim solves common CAD problems:

- >> Open native CAD models from all major traditional CAD systems
- >> Repair poor geometry quickly and easily
- >> Optimize CAD models for input to all major CAE systems
- >> Prepare CAD models yourself for meshing and analysis
- >> Work confidently in 3D without the complexities of traditional CAD
- >> Support and enable simulation-driven design initiatives

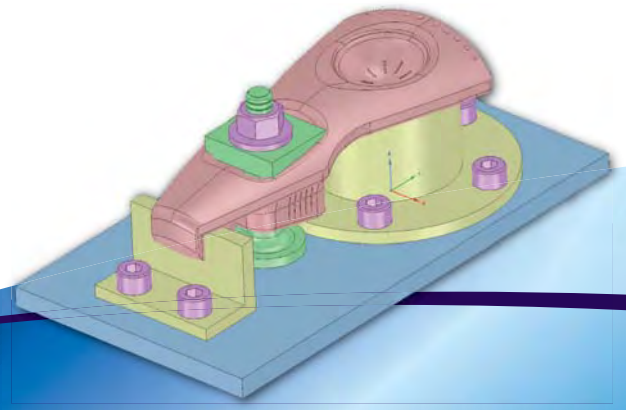

SpaceClaim Engineer:
Powerful yet easy-to-use 3D for all engineers.

Toll Free: 800-636-6004 +1-978-482-2148 info@spaceclaim.com

© Copyright 2012 SpaceClaim Corporation. SpaceClaim is a registered trademark of SpaceClaim Corporation. All other names mentioned herein are either trademarks or registered trademarks of their respective owners.

 **SPACECLAIM**
CORPORATION

Visit Us Online at www.spaceclaim.com





Shape Changing Lubricants

Shell is using simulation to find and optimize the right lubricants in complex friction problems. Up until recently, Dr. Robert Ian Taylor and his team have used proprietary programs to simulate these applications. But as they increase the ambitions and complexity of their simulations, they are now turning to COMSOL Multiphysics.

BY JENNIFER HAND

Lubricants are increasingly being seen as critical to fuel economy and this has become one of the main drivers for development. Lubricants that can deliver better fuel economy or improved energy efficiency are in demand and the market is huge. Independent consultants Kline & Company estimate that the global requirement in 2010 was almost 38 million tonnes, approximately 44 billion litres.

According to Dr. Robert Ian Taylor, Technology Manager at Shell Research in the UK, a reduction in lubricant viscosity is regarded as one of the key approaches to energy efficiency, and the choice of base oil is significant. "There is a move towards synthetics, in which molecules are highly controlled, often by further processing of mineral base oils. 'Slippery' chemical additives, called friction modifiers, are also being used."

In general, energy efficient lubricants deliver lower friction because the oil film thickness in the contact is reduced. Of

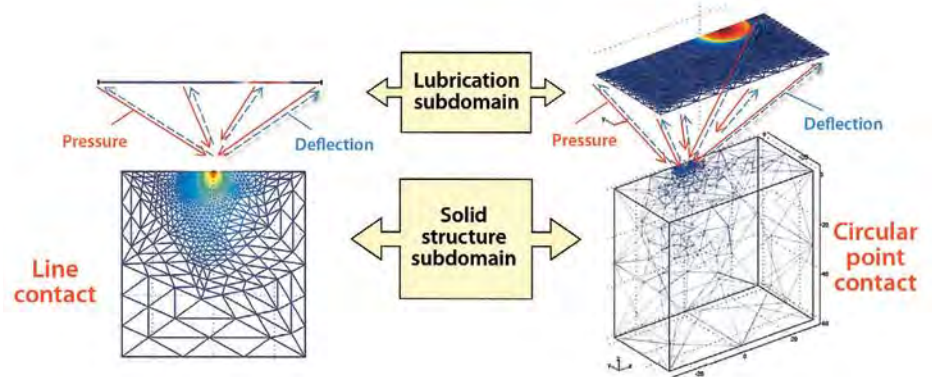

Figure 1. Schematic of multiphysics approach to solving lubrication problems. The Reynolds' equation is solved on the line, or surface. The calculated pressure distribution is then used to calculate elastic deformations and this process is repeated until convergence is obtained.

extremely high pressures of up to 3 or 4 GPa can be generated in the lubricant. Under such pressures the viscosity of the lubricant increases dramatically causing metal surfaces to deform elastically. As a consequence of these two effects, the oil film thickness is greater than otherwise expected, which is exactly why such high-

films than one micron, so shear rates are correspondingly higher. Any mathematical models we develop must be capable of allowing for varying rheological descriptions of the lubricant."

For a lubricated line contact, such as the sliding of a cylinder against a flat surface under steady loading conditions, any equations used need to take account of numerous attributes. These include lubricant oil film thickness at different positions in relation to the contact; the corresponding pressure that determines lubricant density; lubricant dynamic viscosity; the relative speed of moving surfaces; the reduced radius of curvature for the contacting surfaces; the reduced Young's modulus of the surfaces; and the load per unit length.

"We end up with some rather complex analytical expressions for the elastic deformation of a medium due to an applied pressure at the surface," admits Dr. Taylor. "It is also worth pointing out that lubricant viscosity is a strongly varying function of pressure. The numerical solution of these equations is not straightforward since the character of the partial differential equation changes at different points in the contact."

"Any mathematical models we develop must be capable of allowing for varying rheological descriptions of the lubricant."

course, if oil film thickness is reduced too much, there is the possibility of higher wear. It is therefore particularly important to be able to predict the effect of lubricant properties on the thickness of the oil film and the friction of a lubricated contact.

"For lubricated contacts, such as plain journal bearings or piston rings, and pressures below 200 MPa, the Reynolds' equation can easily be solved to predict oil film thickness and friction," comments Dr. Taylor. "However, there are many important lubricated contacts, such as gear teeth or rolling element bearings, where

pressure contacts can be successfully lubricated. The fact that high pressure promotes lubrication rather than hinders it can seem a bit non-intuitive. The key is to account for these two effects when predicting performance."

This type of lubrication is known as elastohydrodynamic lubrication and as Dr. Taylor notes, it is no easy matter to measure lubricant rheology, or flow, under such pressures, especially as shear rates can also be as high as 10^8 s^{-1} . "In elastohydrodynamically lubricated contacts we generally have much thinner





“One of the fundamental advantages of COMSOL is that we can develop models without any lines of code whatsoever. This makes maintenance and modification of models much simpler.”

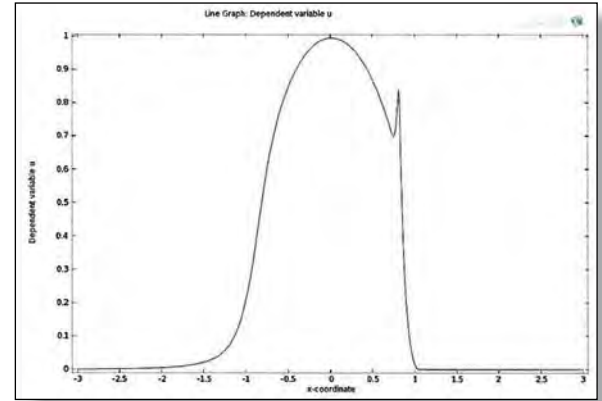

Figure 3. Calculation of pressure distribution in lubricated line contact, using COMSOL. The conditions are the same as those used in Figure 2.

Finite element analysis, using a multi-physics solver, is an approach for taking into consideration all of the participating properties. “We wanted to solve the Reynolds’ equation on the contact line or surface; find the pressure in the lubricant; use that calculated pressure to calculate the elastic deformation in the underlying surface; then use the changed surface shape to recalculate the pressure distribution.” (Figure 1).

The Shell team has found that this approach has converged reasonably well for pressures less than 1 GPa. For higher pressures from higher loads, it becomes necessary to dampen oscillations in the calculated pressure distribution. Dr. Taylor explains: “Small diffusive terms can be added to the Reynolds’ equation, or even better, SUPG (Streamline Upwind Petrov Galerkin) methods can be used to add residual based stabilizing terms to the original equation. This approach then enables successful simulation of contacts for pressures up to 4 GPa.”

Over the years the Shell team has conducted many simulations using a proprietary direct solver, which also uses adaptive meshing. The software, written in a

mixture of FORTRAN and C, consists of approximately 20,000 lines of code although this includes the solver code too. “This solver works very well for smooth surfaces; a small number of discretization nodes; ‘simple’ rheology, with no viscoelasticity; and it assumes Reynolds’ equation holds.” The results shown in Figure 2 are from this solver.

However, the proprietary solver code is not so straightforward to modify and it sometimes poses a steep learning curve for newcomers. Members of the Shell team are increasingly turning to COMSOL Multiphysics for complex lubrication problems (Figure 3).

Over the past three years the team has been using both systems to confirm that they obtain the same results from COMSOL Multiphysics as they do from their own solver. “It is still easy to use the solver for some problems but we use COMSOL for more difficult issues,” says Dr. Taylor. “One of the fundamental advantages of COMSOL is that we can develop models without any lines of code whatsoever. This makes maintenance and

modification of models much simpler. It is also much easier when we need to consider real lubricated contacts. These are rough, at the micron scale, and so a typical 3 mm contact would need to be described by approximately 1,000 nodes, if we model it accurately. This would take up too much computer time and memory for the direct method used in the proprietary solver. Yes, we could use multigrid methods but with this it is often necessary to ‘tweak’ the numerical parameters of the multigrid method in order to get convergence.”

The Shell team is also interested in lubricated ‘point contacts,’ such as rolling element bearings, as there are many billions of these in machines across the world. Some of them are lubricated with grease, a viscoelastic material, rather than a liquid lubricant. “Whereas the Reynolds’ lubrication equation cannot be used for viscoelastic fluids without significant modification, COMSOL could solve the same lubricated contact with the full Navier-Stokes equations, using the correct viscoelastic properties of the grease,” Dr. Taylor observes. “As most lubricated contacts are subject to time varying loads, the ability to predict the time dependence of oil film thickness and friction is essential. We have in fact already used COMSOL to look at such effects for gear teeth, which are effectively line contacts.”

The accurate modeling of grease lubricated rolling element-bearing contacts is now an active area of current research for many companies, including Shell, and Dr. Taylor expects to be making even more use of COMSOL Multiphysics. ■

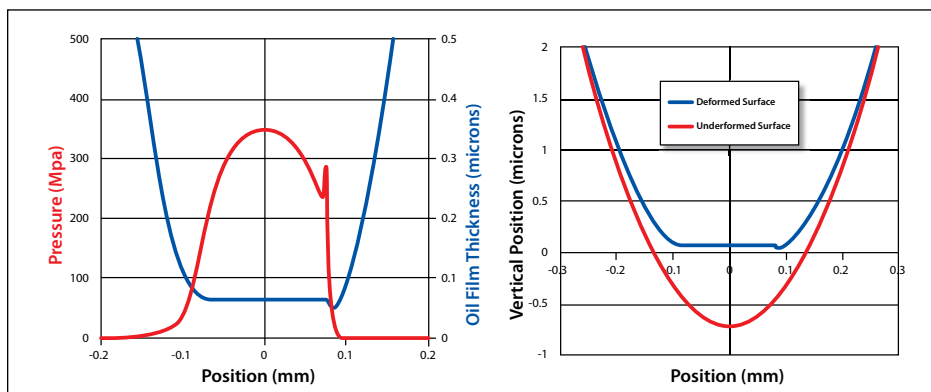

Figure 2. Typical calculated oil film thickness (red curves) and pressure (blue curves) for an elastohydrodynamically lubricated line contact. The simulations were performed for an oil temperature of 373 K and a contact entrainment speed of 10 m/s, which is typical for gear contacts. The results are from Shell’s proprietary solver.





An umbilical cable on a drum ready to be placed on a ship for laying.

Analysis of Subsea Umbilicals and Cables

Simulation has enabled JDR to provide its customers with full stress analysis in addition to physical testing. At half the cost for five times the amount of data, this option is now a popular choice.

BY JENNIFER HAND

Deep water pressure, wind and wave forces, and the rough ocean bed — these all have to be anticipated in the design of underwater cables for the offshore oil and gas industry. Known as umbilical systems and housing power, hydraulic control, electric signal, fiber optic and chemical injection links, these umbilicals must be extremely durable, particularly under severe coupled bending, torsional and axial loads. In addition to these harsh conditions, they have to withstand handling under tension as they are reeled out and back numerous times by a winch designed to have a tight radius to minimize its footprint on a ship's deck.

Because umbilicals are long, they need to be strong, and are generally very heavy and difficult to handle. Thus, the physical testing of these cables is cumbersome and expensive. Tim Poole, Design Automation Engineer, is responsible for testing and analyzing products at JDR, which custom-designs and manufactures subsea power cables, umbilical systems and reeler packages for a broad range of applications in the oil and gas and renewable

sectors. “In order to understand fatigue properties and performance, a typical fatigue regime for an umbilical is to undergo 100,000 usage cycles around a sheave wheel on a large fatigue rig. At approximately 6,000 cycles per day, plus all the other required testing, it takes at least a month to complete the process and costs between \$30,000 and \$50,000 for all the resources involved. It is critical that we

JDR was already using OrcaFlex, the specialist package designed for the offshore marine industry, for global analysis of the whole system formed by ship, cable, seabed, weather, water and wellhead. After ISO standards were updated in 2009 with new specifications for the analysis of umbilicals, JDR began conducting local stress and thermal analysis of their cables.

Umbilicals, however, pose a particularly complex analysis challenge as Poole explains: “Typically they incorporate multiple layers of wire with helical geometries and multiple contact points, or they contain aramid (Kevlar) braid, a synthetic material that is very difficult to analyze because of its braided construction.” JDR therefore turned to COMSOL Certified Consultant, Continuum Blue for some specialist assistance.

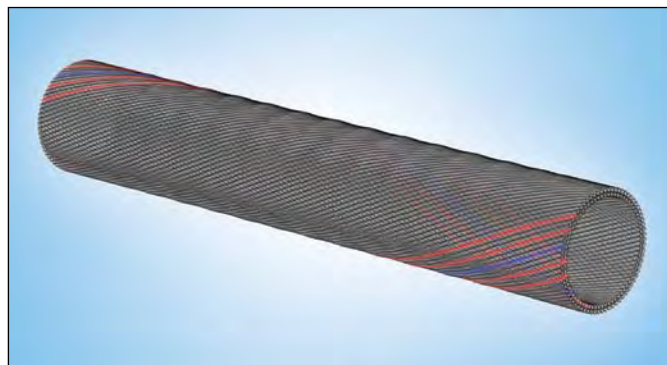

Figure 1. Illustration of the counter-rotating armor layered that includes multiple contact points of individual armor wires.

can predict the behavior of our products to ensure they meet the requirements, so while physical testing is very important, it has its limitations. Apart from the time and cost factors, we cannot replicate conditions 100%.”

Helical Wires with Multiple Contact Points

Dr. Mark Yeoman of Continuum Blue picks up the story. “Our starting point was a 2D cross-section of a cable, including material specifications. What was of con-



“The beauty of COMSOL and their analysis is the option to explore many loading conditions on various cable designs, and compare the results in a very short space of time.”

cern was that the cable cross-section had a double armor layered structure with 50-60 armor wires in each layer, where each layer twisted along the length in the opposite direction to the other layer. Building the model to reflect bend and axial load conditions with contact for the internal structures was done, but also included adding in the contact for these counter-rotating armor wires. This resulted in well over 3,000 localized regions of high contact pressure along a unit length of cable, creating high stresses at every point of contact.” (Figure 1).

Continuum Blue’s answer was to build a bespoke, or customized program, so that JDR could quickly and easily generate the 3D cable structure through COMSOL’s Livelink™ for MATLAB® and then build the COMSOL cable model (Figure 2). The MATLAB® code added advanced material properties and relations from Continuum Blue’s extensive materials database, and utilized these properties

to help define the bespoke contact expressions and parameters that were necessary to solve the contact analysis. Everything was then imported into COMSOL Multiphysics so that it could be solved.” Wires were modeled as contact pairs moving between a sliding surface and analyzed for pure bending, pure tension and a combination of both.

According to Dr. Yeoman, the beauty of COMSOL and multiphysics analysis is the option to explore many loading conditions on various cable designs, and compare the results in a very short space of time.

“It now takes two days to build a full 3D cable model ready to solve from an initial design and 2D drawing, and from there it is left to COMSOL to solve the various load conditions needed to be assessed. We can conduct seven or eight different types of analyses. For example, we test different axial load conditions and various bend radiuses. This allows JDR to assess many design scenarios, where comprehensive stress, strains, and contact analysis plots can be analyzed, ensuring cable survival during laying and use. This improves the life of the cable, while reducing the costs involved in testing and manufacture.” (Figure 3).

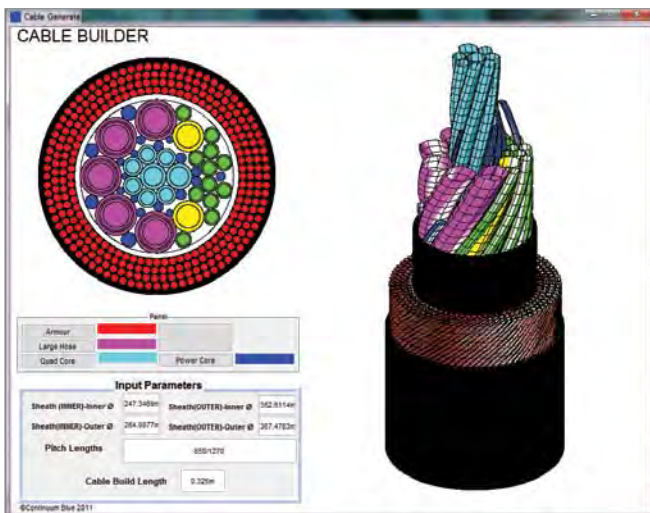

Figure 2. Screenshot of the bespoke Cable Building code, illustrating Schematics of Cable Cross Section (top left), input parameters (bottom left) and sectional 3D Structure (right). Colored regions indicate various components within a subsea cable that include armor layers (red), various hose types (large high pressure (magenta), medium pressure (yellow) and low pressure (green)), quad core structures for power and data transmission (cyan) and various filler elements (blue).

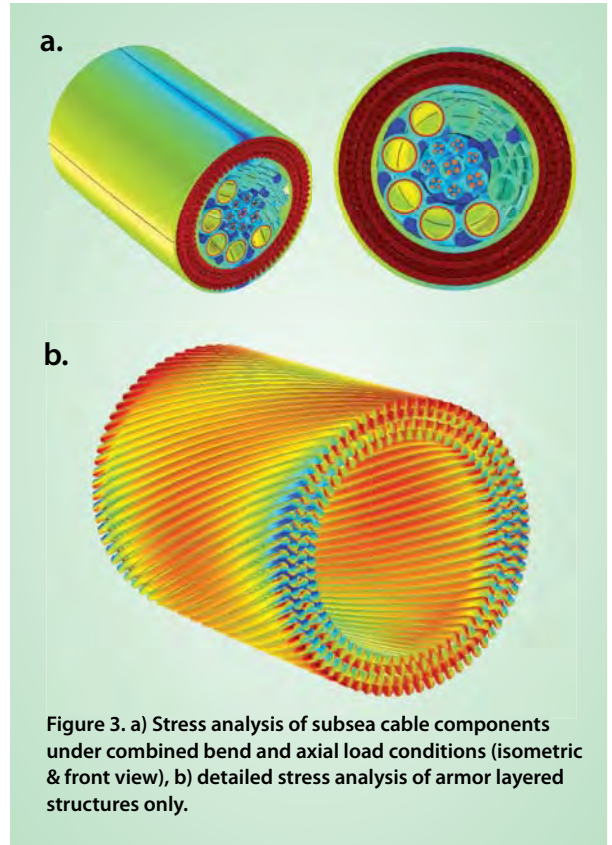

Figure 3. a) Stress analysis of subsea cable components under combined bend and axial load conditions (isometric & front view), b) detailed stress analysis of armor layered structures only.

More Information, Less Cost

“The first time we adopted this approach it worked really well,” comments Poole. “The models were clear, the local stress analysis was reliable and we were able to feed the values obtained into our OrcaFlex models.” JDR has now worked with Continuum Blue on developing its capabilities, and JDR can now analyze subsea cable structures with multiple internal counter-rotating structures and up to six protective armor layers with ease. From ten weeks on the original project, turn-around time is now down to two weeks and the amount of data produced has risen five fold. “Not only are we able to analyze the fatigue characteristics of our umbilicals using COMSOL, we are also able to analyze thermal characteristics.”

Analysis can be half the cost of physical testing. While some of JDR’s customers still choose physical testing, others are opting for a combination of global and local analysis. “We are simply providing our customers with a choice and we plan to extend our use of COMSOL so that we can continue to give them more information,” concludes Poole. ■





Multiphysics Analysis of Pressurized CO₂ Foil Thrust Bearing Characteristics

The use of multiphysics simulation provides the means of assessing the performance of foil thrust bearings.

BY EDWARD BROWN, CONTRIBUTING EDITOR, TECH BRIEFS MEDIA GROUP

The Knolls Atomic Power Laboratory (KAPL) and Bettis Atomic Power Laboratory are testing a supercritical carbon dioxide (S-CO₂) Brayton power cycle system with a 100 kW electric power output (kWe). The 100 kWe Integrated System Test (IST) is a two-shaft recuperated closed Brayton cycle with a variable-speed turbine-driven compressor and a constant-speed turbine-driven generator using S-CO₂ as the working fluid. The main goals of the IST are to provide test data to verify the ability to model important thermodynamic characteristics of an S-CO₂ Brayton cycle system and to demonstrate S-CO₂ Brayton cycle system controllability in various operating modes and transients.

Supercritical CO₂ is a means of providing high energy conversion efficiency at moderate temperatures, as compared to a helium system. Near the critical point, carbon dioxide rises to a very high density — about 700 kg per cubic meter —

“COMSOL Multiphysics was used to model the thrust bearing over the speed range of operation.”

close to the density of water. This means that the compressor acts more like a pump. The high density of the CO₂ working fluid is what makes it possible to use

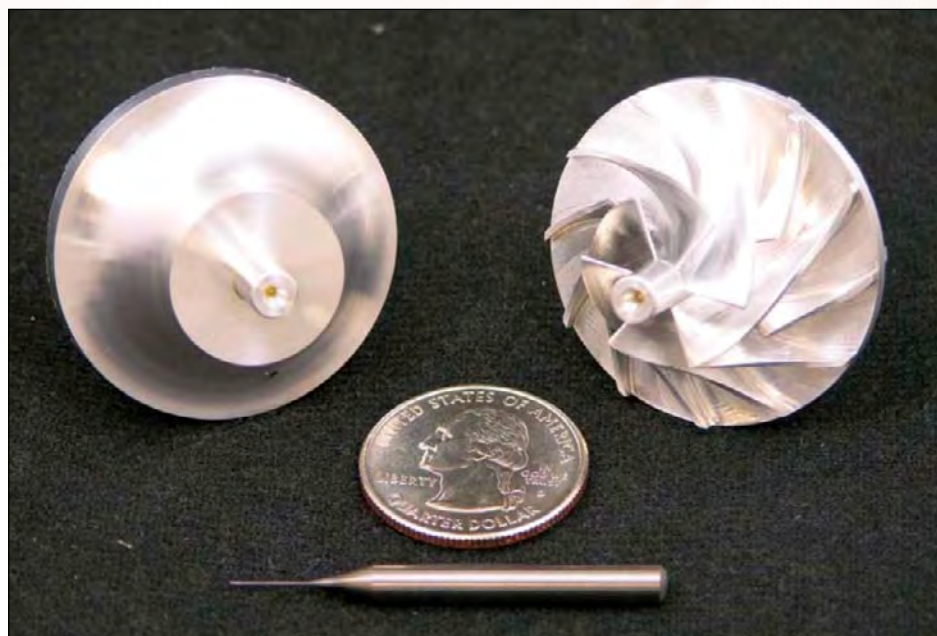

Figure 1. Representative size of IST compressor.

smaller components, rotating at higher speeds, with fewer turbine stages than for a comparably rated helium closed-loop Brayton power system (Figure 1). It takes far less work to run the compressor, so it requires less input energy to generate a given output. Note, it is not practical to build an S-CO₂ system for generating any power less than 100kWe because the turbomachinery would have to be too small and too fast.

System Operating Conditions

A critical factor for system operation at high operating speed and high gas pressure is that the turbine shaft bearings

must withstand a wide range of radial and axial loads. Gas foil journal bearings to handle the radial load were manufactured by Capstone Turbine Corporation. The thrust bearing (Figure 2), used for constraining the axial forces, was designed by NASA Glenn Research Center and manufactured by Barber Nichols, Inc. Under IST operating conditions, the bearings must eventually operate at 75,000 rpm in 200 psia CO₂. However, during component testing, undesirable thrust bearing wear patterns were observed at shaft speeds of less than 35,000 rpm (Figure 3), even with bearing temperatures that were maintained at well below the



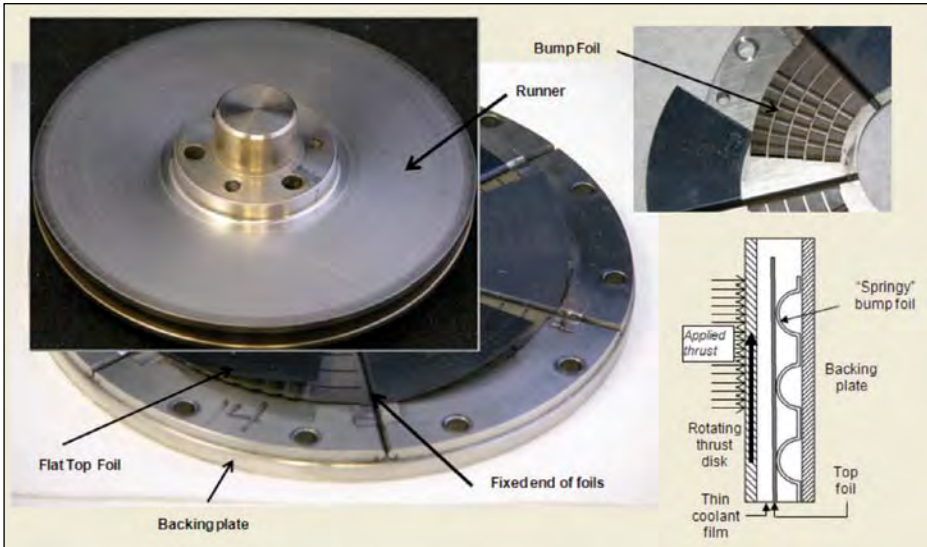

Figure 2. Parts of a thrust foil bearing.

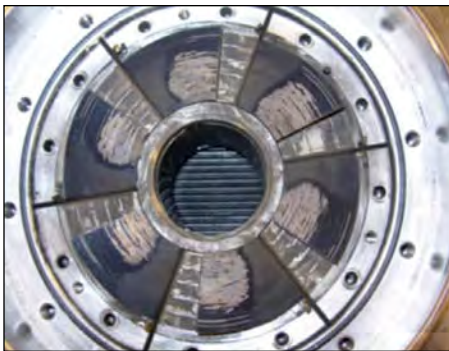

Figure 3. Foil thrust bearing wear after a short time in service.

imposed 400 °F operational limit. In some cases, complete destruction of the foils occurred. Multiphysics analysis was performed by KAPL to provide insights into identifying potential failure mechanisms. COMSOL Multiphysics was used to model the thrust bearing over the speed range of operation.

Thrust Bearing Structure

The thrust bearing, as shown Figure 2, consists of four components. From top to bottom:

- The runner, which is attached to the rotating turbomachine shaft. This is what imparts the thrust load to the bearing. Its spinning surface forms the upper boundary for the CO₂ lubricating film.
- The flat top foil, which provides the lower boundary for the development of the thin film that generates the hydrodynamic pressure to counteract the thrust load.
- The bump foil, which is a spring-like structure with bumps that are deflected under load, providing the bearing compliance.
- The backing plate provides support for the top and bump foils.

Modeling

Trevor Munroe of Knolls Atomic Power Laboratory, Niskayuna, NY, performed an analysis for understanding the failure mechanism of the bearing. Turbomachinery designed for sealed systems must contend with viscous power loss attributed to bearings and rotor windage. This power loss can reduce turbomachinery performance and necessitate additional cooling mechanisms due to fluid heat build-up. COMSOL Multiphysics can couple built-in structural mechanics, fluid mechanics, and heat transfer options.

The model should account for:

- Contact and rubbing (friction) between the top foil and the bump foil as well as between the bump foil and the backing plate. Axial displacement and rotation of the runner.
- The interaction between the fluid (supercritical CO₂) and the structure (particularly in the thin film region).
- Viscous heat generation, particularly between the runner and the flat top foil along with the accompanying heat transfer by conduction and convection.

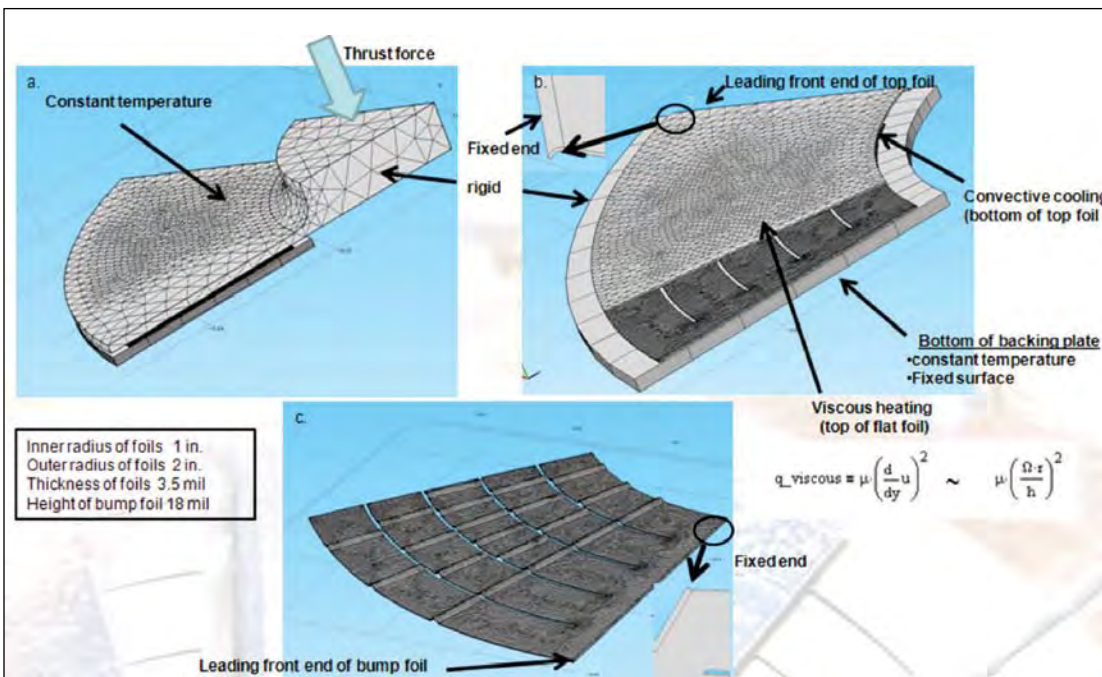

Figure 4. Foil thrust bearing model boundary conditions.



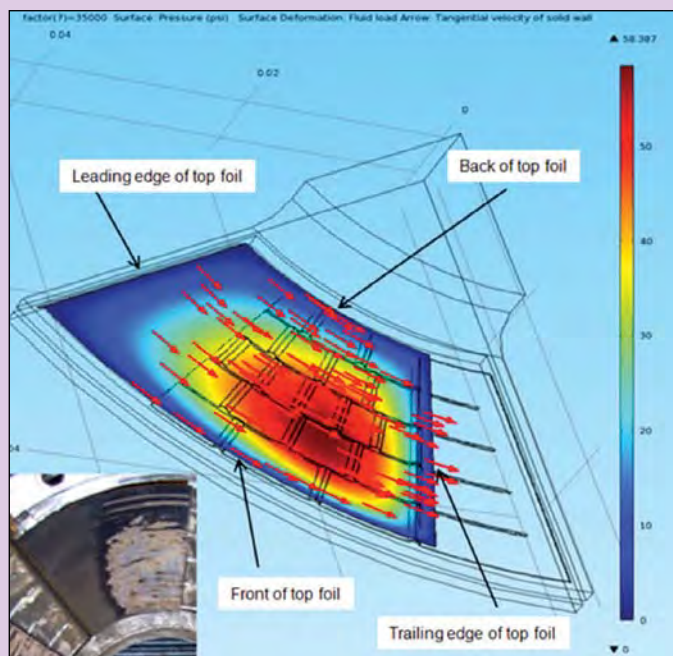

Figure 5. Top foil pressure distribution at 35,000 rpm. (red indicates higher pressure)

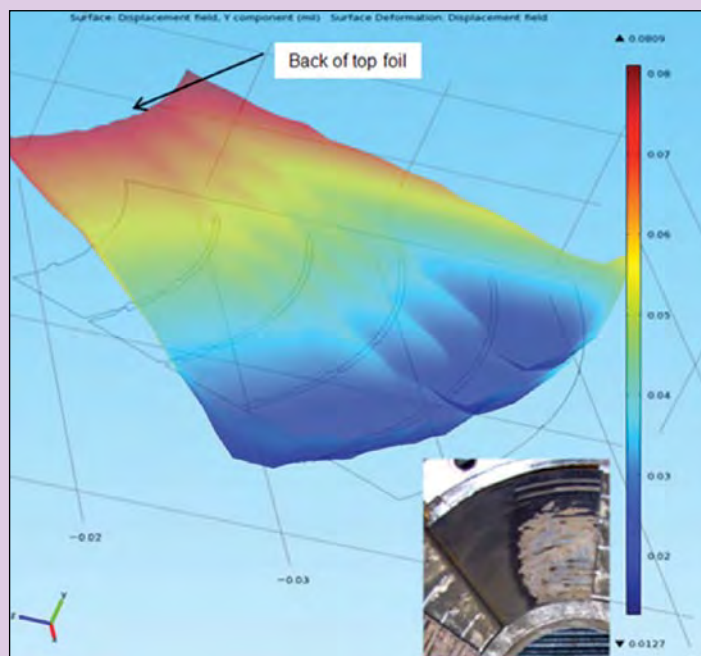

Figure 6. Top foil distortion at 35,000 rpm. (red indicates greater thermal growth)

The model must take account of the effects of thermal expansion of the foils.

Analysis

Munroe imported a three-dimensional Pro/ENGINEER® model of the bearing's physical geometry as shown by Figure 4. He then set up the boundary conditions as indicated. He made some simplifying assumptions to minimize the necessary computer resources. The first compromise was to use the Thin-Film Reynolds equation option (lubrication model) in the CFD Module to model pressure in the thin-film region. This avoids the complication of meshing an extremely long aspect ratio volume. Heat transfer boundary conditions were applied to model the cooling flow external to the thin film region. The next simplifications concerned the structural and thermal elements. The heights of the runner and backing plate were reduced in order to minimize the number of mesh elements needed for the model. The modulus of elasticity was increased to compensate for the reduced thickness in order to ensure that these components would remain relatively rigid. Future analyses could be improved by applying

the thin-film boundary layer option within the thin film region and full Navier-Stokes equations option within the cooling flow regions.

Results

The results for a case with a thrust load of 30 lbs and a range of rotational speed of 5,000 rpm to 35,000 rpm are presented in Figures 5 and 6. Figure 5 shows the pressure distribution on the top foil. The arrow shows the rotational direction of the runner. As would be expected, the maximum pressure is towards the region of diminishing film height (ranges from 0.12 mm to 0.28 mm over the range of speed) or away from the leading edge of the flat foil. The maximum pressure of 58.88 psi is shown. Integration of the pressure distribution over the surface of the top foil or runner results in an overall force of 30 lbs., which balances the imposed force.

Figure 6 shows the distortion of the bump foil under non-isothermal conditions. Under non-isothermal conditions the distortion increases with rotational speed. For the isothermal case, the distortion is not noticeable since the thrust

load is being kept constant over the range of rotational speed. This distortion of the bump foil is related to the effect of thermal expansion. The inserted images in Figures 5 and 6 show that more wear of the flat foil seems to occur in the area of high pressure and higher thermal growth.

Conclusions

COMSOL Multiphysics has the essential features necessary to assess the performance of foil thrust bearings. The results indicated that thermal expansion of the bump foil due to viscous heating is an area of concern. COMSOL provides additional capabilities to model flow and heat transfer beyond those used for this work. Future analyses should incorporate a 3D fluid flow model outside the region of the lubricating film to address the cooling and flow distribution issues throughout the bearing and optimize foil geometry to improve bearing performance. ■

RESEARCH PAPER

www.comsol.com/papers/11397/

Pro/ENGINEER is a registered trademark of Parametric Technology Corporation.





Pumping and Injecting from a single Borehole

Düsensauginfiltration, which translates as ‘nozzle-suction-infiltration,’ is a technology for dewatering that avoids the effort, costs and environmental risks of conveying water from the original site. Modeling is being used to understand why and how this novel approach works.

BY JENNIFER HAND

CO-AUTHORED BY PROF. MARTIN SAUTER, PH.D STUDENT YULAN JIN, AND ASSOC. PROF. EKKEHARD HOLZBECHER, GEORG-AUGUST-UNIVERSITY

Groundwater levels often need to be lowered in order to keep construction or mining sites dry. Known as achieving ‘drawdown,’ the traditional approach is to abstract (pump out) water,

“We are modeling alongside field experiments that are taking place in Germany so that we can compare results with measured data.”

and discharge it back into the ground away from the site or into a surface water body. This approach can have a negative impact on the environment. The local ecosystems at each site are disrupted and subsidence, contamination of ground or surface water, and soil degradation are all potential consequences. In addition, there are the costs of transport and disposal, with increased expenses if

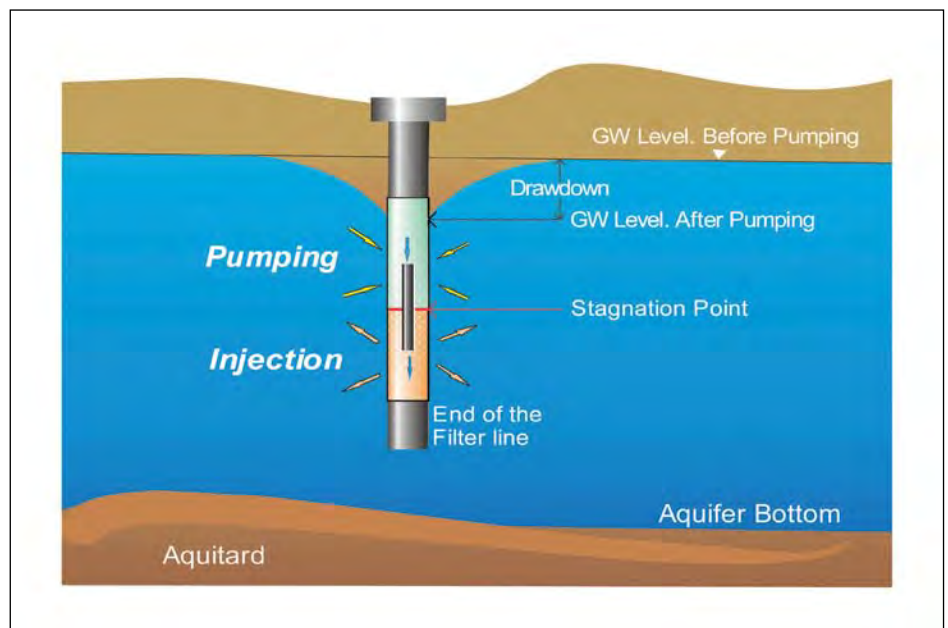

Figure 1. Sketch of the borehole abstraction (pumping) and infiltration (injection) concept.

water needs to be treated before it can be returned to the ground.

In contrast, Düsensauginfiltration (DSI) involves abstraction of groundwater near the groundwater table with injection into the same borehole, but at a

greater depth. This avoids the transport of water away from the site as water is not lifted at all, and also has the effect of reducing subsidence. In effect, the borehole is separated into two parts: the upper part of the borehole is the abstrac-

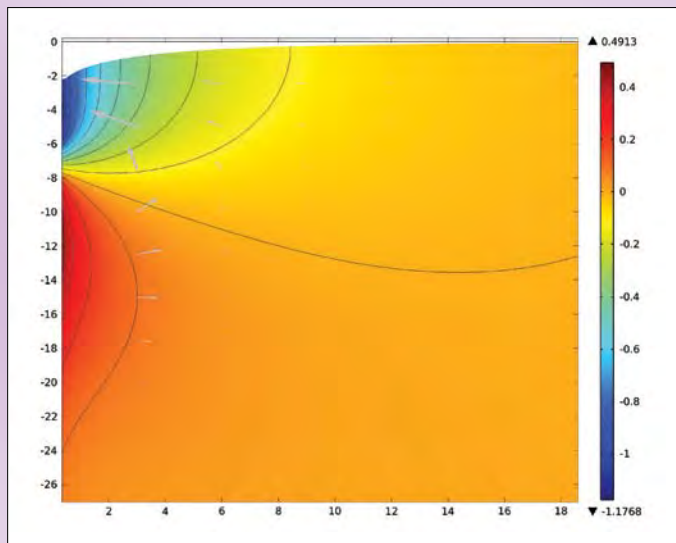

Figure 2. Example of 2D vertical cross-section model output. Shown are the hydraulic head (color plot), deformation and velocity field (arrow plot) within the aquifer.

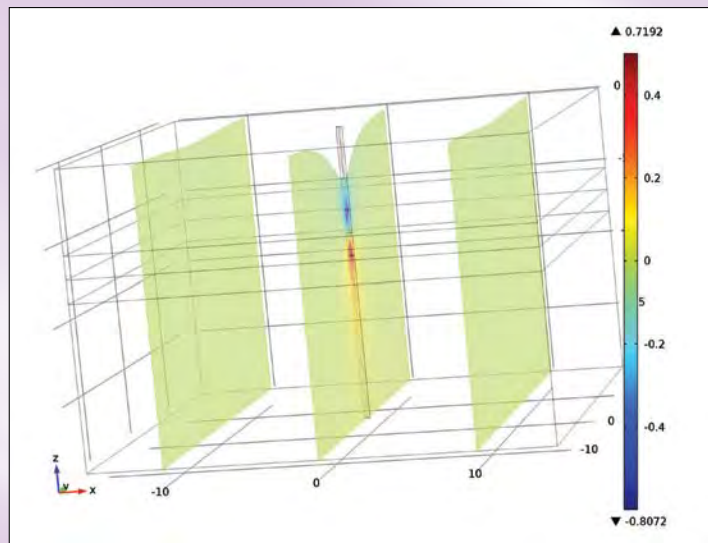

Figure 3. Slice view of the 3D model output with hydraulic head profile (color plot) and deformation of the borehole.

tion section and the lower is the reinjection section. These two parts are usually separated by packers (Figure 1).

Well hydraulics expert, Werner Wils, has successfully used this method, also known as JSISWW (Jet Suction Infiltration System Werner Wils) in his company since 2000. It has attracted much attention in Germany and Netherlands, where there are companies licensed to use the system, and is also being used in Vietnam and China. Practical experience shows that it is successful, yet it is not completely understood. It is not clear under which conditions the technology works and in which situations it would not work. The challenge is to examine the technique scientifically and this is being done at the Georg-August-University of Göttingen.

The Department of Applied Geology of the University of Göttingen, led by Prof. Dr. Martin Sauter, concentrates on research in the field of hydrogeology and is cooperating with Hölscher Wasserbau, a leading German dewatering company, within the framework of the DSI project. The project is financially supported by Deutsche Bundesstiftung Umwelt (DBU).

“Our role is to explain why this method achieves results, to understand its ad-

vantages and limitations, and identify in which situations it would work best,” comments Assoc. Prof. Dr. Ekkehard Holzbecher, who leads the research team. Yulan Jin, a doctoral student, is responsible for simulation within COMSOL Multiphysics using both 2D and 3D models. She describes the objectives: “We are modeling alongside field experiments that are taking place in Germany so that we can compare results with measured data. We want to accurately predict the response of the system to changing boundary conditions.”

Proving the Basic Principle

A model solving for pressure (or hydraulic head) and the deformation of the aquifer, was set up in 2D, where Figure 2 shows a typical result. As the hydraulic head is lowered at the upper part of the borehole (indicated in blue) it creates a drawdown of the upper boundary, representing the groundwater table. This demonstrates the fundamental principle that drawdown does occur in the aquifer, even if water is injected into the lower part.

The same situation was then modeled in 3D to take into account ambient groundwater flow. The borehole, which is represented as a cylinder, included depth-dependent abstraction or injec-

“We used the parametric sweep feature in COMSOL Multiphysics to perform an extensive study that focused on different infiltration rates while the abstraction rates were kept constant.”

tion rates and were specified as sources and sinks in the mathematical model. In the results for the test case depicted in Figure 3, the same drawdown phenomena as the 2D model were apparent.

“We used the parametric sweep feature in COMSOL Multiphysics to perform an extensive study that focused on different infiltration rates while the abstraction rates were kept constant,” explains Jin. “This enabled us to make a comparison with the classical method where water is pumped out or abstracted and there is no infiltration. We found that when abstraction and infiltration rates are equal, the DSI technology yields half the drawdown rate of the conventional technique of pumping

alone. While drawdown still occurs, it is more manageable than if water was removed from the site.” This is illustrated in Figure 4 in which the hydraulic head variation along the groundwater table away from the well is displayed for different infiltration rates.

So far, numerical simulation results show the same trends as measured data from the field. “Simulation is really helping us to see why, how and when DSI works,” says Jin. “For example, we learned that it can only be applied to permeable aquifers, made up mainly of sand and gravel. We have also discovered that sufficient amounts of regional groundwater is critical as it positively affects the rate of infiltration. Moreover, the anisotropy of hydraulic conductivity of the aquifer plays an important role. In particular, it must be considered that as groundwater flow changes with the seasons, it also changes according to the relative conductivity of different layers within an aquifer. One problem is that water injected into the lower part of a borehole may create a local bypass or ‘short-circuit’ within the process. All these situations are examined using our modeling approach”

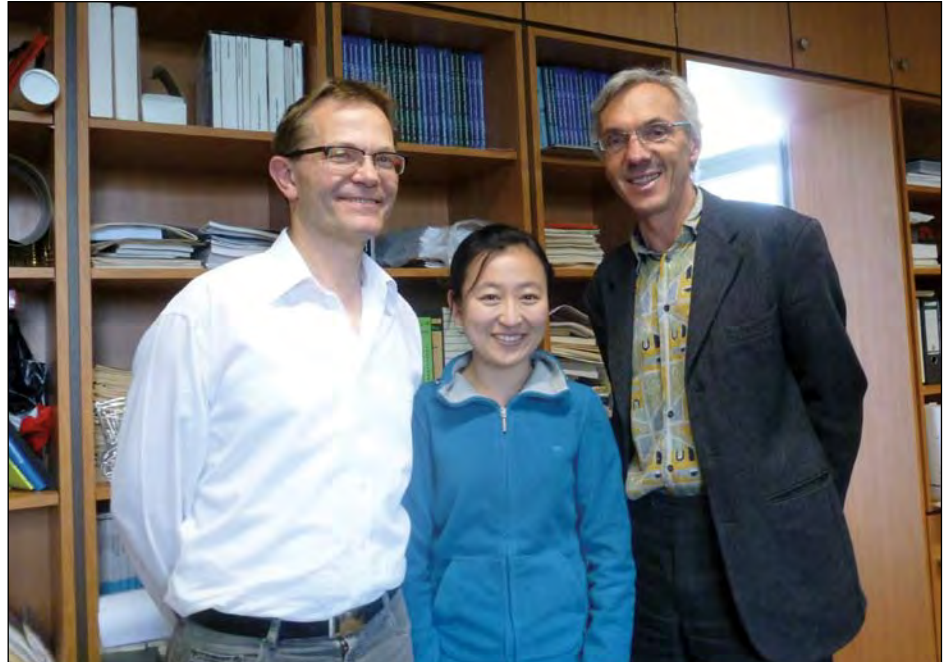

(From left) Prof. Martin Sauter, Ph.D Student Yulan Jin, and Assoc. Prof. Dr. Ekkehard Holzbecher.

Generating Specific Guidelines

One of the DSI application sites is in the immediate vicinity of an abandoned mining site. “We are dealing with a genuine problem as there has been flooding of basements in houses due to the closing of the old mining site,” explains

Jin. “Because it is an open aquifer, it is not suitable for conventional dewatering methods anyway because pumping would have to be continuous.” Jin is adding new parameters to the 3D model as she receives data from the field experiments and this expands the ability of the model to reflect all the real-life variables that may apply. “It is clear that the point at which injection takes place, the size of nozzle, flow rate and corresponding pressure all have to be combined. We are therefore moving towards more complicated, heterogeneous conditions. We are also accounting for several boreholes in one site.”

Having proved that the DSI method works, with some limitations, the university team is now focusing on optimization. Jin concludes: “DSI has many advantages. Yet we know that even when experts with experience use DSI, it can take several days of trial and error to work out where to drill and how many boreholes are required. Through simulation we will be able to produce specific guidelines that will save time and effort on site and enable this method to be taught effectively and replicated successfully.” ■

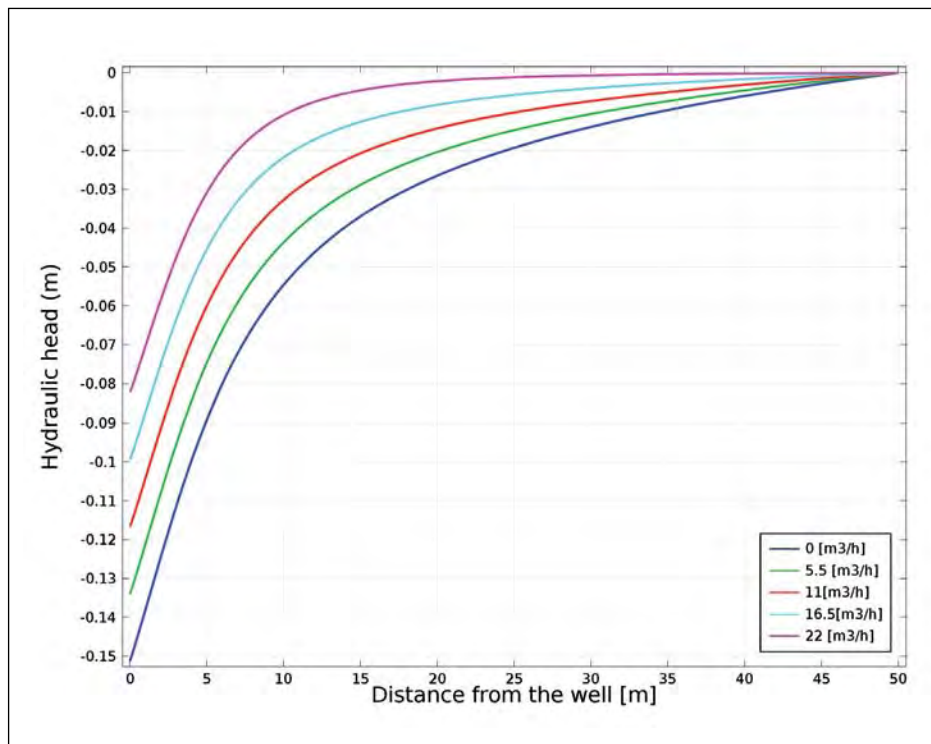

Figure 4. Decreased drawdown with increased infiltration rates.

RESEARCH PAPER

www.comsol.com/papers/11083/

The Science of Water Screening

Custom design of water intake screens by using fluid and mechanical simulation cut development costs.

BY EDWARD BROWN, CONTRIBUTING EDITOR, TECH BRIEFS MEDIA GROUP

Natural sources of water are vital to our way of life. We use water that either comes by way of public water supply systems, or directly from wells or springs. Water from lakes, rivers, or oceans has to be treated before it is usable, even if it is not intended for human consumption. Water for cooling or for generating steam in power plants and industrial processes has to be free of debris so as not to clog pumps, valves, pipes, or machinery.

Johnson Screens® is one of the most experienced manufacturers of steel screens to block debris without harming fish and other wildlife. Throughout this history, some of the varied applications for these screens have been in hydrocarbon processing, architecture, pulp and paper production, mineral mining, and food processing.

Complications

You might think that there's nothing complicated about a wire screen, or that there is not much difference between a water screen and a window screen. But they are very different.

The first challenge is that the openings in the water screen have to be large enough for an unimpeded flow of water,



Figure 1. Unique V-shaped wire structure prevents clogging.



Figure 2. Johnson Screens' Ehrich Shaw next to a small intake screen.

but small enough to block debris. An additional problem is that if debris gets trapped in the openings, the water flow will slow down over time. It's also important to avoid environmental effects on the water life, so the flow has to be slow, smooth, and uniform. This is a challenge because this device has no moving parts — it's completely passive. To protect fish and other life, there should be no "entrapment"; that is, things becoming attached to the screen, and no "entrainment"; things being drawn to the screen.

Solutions

Johnson Screens is the inventor of a unique V-shaped wire (Figure 1), with the surface facing the water having a flat face, and the sides tapering inward from the face to form the V. This has a number of advantages. There are only two points that contact particles, and since the space between the walls of the screen widens as the water travels through, particles will not become wedged in place. Also, the outside surface of the screen is very smooth and flat, which cuts down on abrasion to passing wildlife or other materials.

The intake screen is manufactured by a specially built machine that wraps the wire around a cylindrical support structure and automatically resistance-welds it at each point where the wire contacts the supports. A water bath cools the assembly during the welding process to limit the heat in order to prevent warping or uneven slot tolerances. These spacings are critical for achieving performance according to the design. Final assembly is then completed by skilled, certified welders.

Structure

The screen has to be designed so that the flow and structural criteria are achieved with a passive device — no moving parts. The basic structural element of the screen is a drum with the wire wrapped around it in the form of a helix. A single drum is generally used only where space or lifting capacity is limited. Most applications use a tee screen, which is constructed of two drums joined to a central outlet fitting.

After the wire design, the key component of the system is the internal, open-pipe flow modifier, which was developed more than 30 years ago and upgraded to a



patented, multiple, but normally dual-pipe flow modifier in 1999. Its structure and dimensions are what enable passive control of the flow rate (Figure 3).

The third major component is the Hydroburst™ backwash system, which allows the screen to be cleaned by a short burst of compressed air without requiring the system to be shut down.

Key Design Factors

Each screen is custom-designed for a particular application, taking into account the typical characteristics of the debris, the turbulence of the water source, and the depth at which the screen will be placed. The screen has to be designed to effectively prevent solid particles from entering the user's water supply, while being nearly invisible to the flow. The velocity of the flow should be low enough so that there will be minimal influence on particles passing it by. This is achieved by maintaining the flow at a slow and constant rate, and keeping it uniform over the surface of the screen.

The distance from the screen for which it will have some effect on its environment is called the zone of influence, and should be as small as possible. The design of the flow modifier usually keeps this zone of influence to no more than half of the screen diameter.

Wire Design

The size of the wire can theoretically range from 0.020 to 0.191 inches (0.5 to

“Each screen is custom-designed for a particular application.”

4.9 mm). The wire is selected based on its structural characteristics — the ability to withstand depth and impact loading — while providing enough open area for the desired flow. The screen must be designed to take into account the maximum allowable flow rate, which is usually determined by biology experts as being a safe velocity for water passing through the screen to allow fish to escape, and to limit entrapment and entrainment effects. The flow capacity of the screen is determined by multiplying the open area by the allowable average velocity.

Flow Modifier

The open-pipe flow modifier controls the flow rate through the screen. The dual concentric design is an improvement over the earlier single-pipe design in that it allows the same flow velocity with a 20 to 30% smaller intake. The cumulative velocity at the screen surface is controlled by the relative sizing and positioning of the two or more concentric tubes in the interior of the intake. Since the open area at the surface of the screen is so small, it has only a very localized effect on the flow acceleration. Most of the control is therefore achieved by the flow modifiers.

The flow curve (Figure 4) illustrates the typical variation in velocity along the length of the screen for the original single flow modifier and the new dual-pipe design (it is uniform around the circumference). The ideal profile would be a straight line from end to end. A measure of the deviation from ideal is the ratio of average to peak velocities (the ideal case being 1). The higher the ratio, the greater the ability to achieve higher flow rates with smaller screens. Smaller screens have less of a zone of influence and are usually more economical to implement — they require smaller pipes to connect to the water use point.

COMSOL Multiphysics Modeling

The details for each screen have to be designed for the particular application. The design has to take into account fluid dynamics and structural mechanics — a perfect problem for COMSOL Multiphysics, with its ability to model the interactions of these different elements.

Michael Ekholm, Manager, Applications and Product Development for Johnson Screens said, “The design and development of these screens was not accidental. It requires the ability to accurately predict the flow pattern in and around the screen (Figure 5). With a modeling tool such as COMSOL, we can use a variety of methods in this study. Depending on the requirements and flow capacities, this can vary between laminar and turbu-

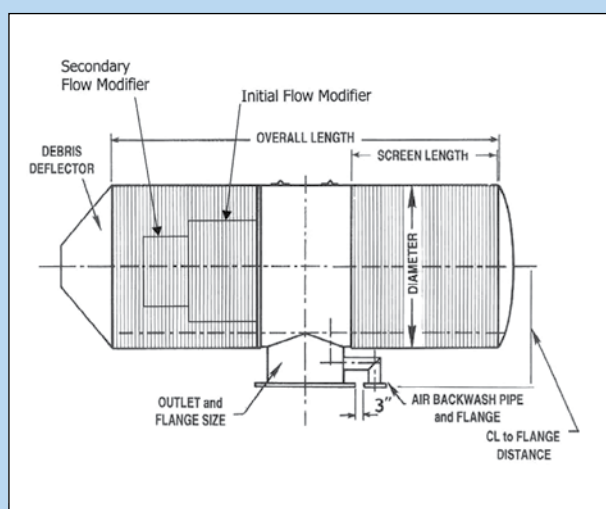

Figure 3. Key components of the screen assembly.

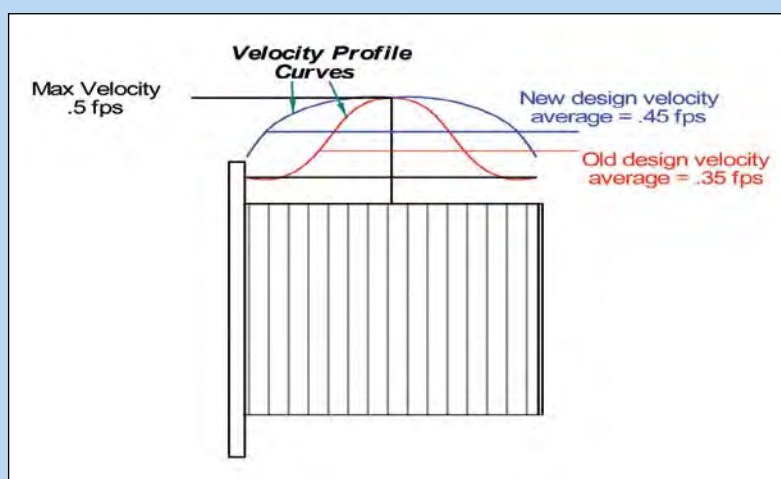

Figure 4. Comparison of the flow velocity distribution for dual-pipe versus single-pipe designs.



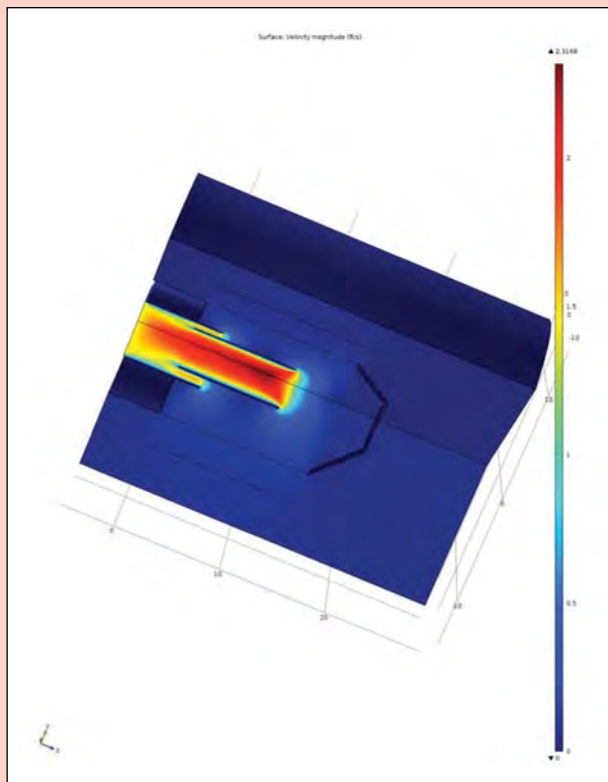

Figure 5. Multiphysics model of the velocity distribution. Flow is lowest surrounding the exterior of the screen and highest inside the screen within the dual-pipe flow modifier.

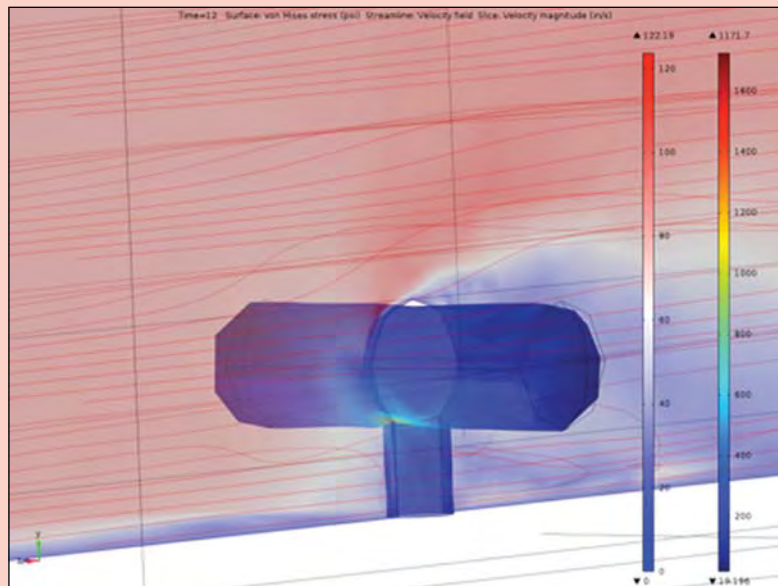

Figure 6. Multiphysics model of the combined effects of wave loading on flow and structural stress.

lent conditions. Changes such as extending the aspect ratio between the diameter and length of the screen, optimizing the flow performance, and adding new features such as a triple flow modifier are possible using modeling. Extensive costs in consulting and analysis were saved by implementing COMSOL as an in-house modeling tool.”

Not only does it help in the design, but, as Ekholm explained, “The extensive graphing and solution illustration capabilities in the software allow the presentation of the predicted performance to be easily used in reports critical to permitting and acceptance documents.”

Wave Loading

Wave loading is a problem that is particularly suited to modeling. Wave loading is the term given to cyclical surges of water acting on the screen, which not only causes changes in the impinging velocity and pressure, but can also vary in angle of action. COMSOL’s built-in, time-dependent solvers and cyclical functions are ideal for handling this problem. The multiphysics software is used for model-

ing the structural problems caused by the wave loading. The resultant loads from a computational fluid dynamics (CFD) analysis for the wave models are applied to a shell/plate structural model of the intake. Key areas of stress concentration can be reviewed to make sure they are below the design stress, and to examine whether a cyclical load such as water waves can cause any fatigue issues (Figure 6).

Hydroburst Air Backwash System

The screens are periodically cleaned with a short burst of air stored in a receiver tank at the surface of the water. The timing and velocity of the air have to be calculated so

that the resultant velocity at the screen surface is not excessive, but is enough to move debris off of the screen. The air introduced helps to float the debris away from the screen that has been pushed off. Fish will only be moved away from the screen as they would in a rapid stream or other natural water effect. A mechanical scraper or other mechanism could injure the fish by contacting them directly.

“What is of interest is the expansion of the air from the screen, to see if it will flow to an adjacent screen in the case modeled. With COMSOL, both the air expansion and the flow into the adjacent screen (zone of influence) can be modeled to provide a realistic view of the event,” said Ekholm.

Multiple Uses of COMSOL Multiphysics

Multiphysics has not only been used for the initial design in this unusual application, but is used to model the complex interactions of fluid, air, and structure for the custom design of each application. It has been proven in tests to provide accurate results, thereby eliminating the need for actual physical modeling. ■

“Extensive costs in consulting and analysis were saved by implementing COMSOL as an in-house modeling tool.”



A Smooth Optical Surface in Minutes

Zeeko's modeling of fluid jet polishing (FJP) has enabled some of its major clients to replace the hand finishing of ultra-precise optical components with a machine process of higher quality that takes a fraction of the time.

BY JENNIFER HAND

Milling, grinding, polishing and finishing: the manufacture of high-quality products such as space telescopes, orthopaedic joints and digital cameras involves a number of precision processes either applied directly to glass or metal, or indirectly to a mold. Whichever method is used, the key requirements are a completely smooth surface and global form accuracy of only a few nanometers. In some cases the only option has been to finish components by hand, a time consuming and highly labor intensive operation.

Looking for a More Efficient Method

Zeeko Ltd is a UK-based technology company that manufactures corrective polishing machines. Its ultra-precision polishing solutions are being used in the development of the European Extremely Large Telescope and the Thirty Meter Telescope to be sited in Hawaii. Dr. Anthony Beaucamp of Zeeko describes the search for a new technology to deliver a higher quality than hand finishing. "There has been a lot of interest in the potential of fluid jet polishing, which pumps a mixture of water and abrasive particles through a nozzle onto a workpiece. This has significant advantages: the footprints generated can be less than a



Figure 2. The Zeeko Intelligent Robotic Polisher. The position and pressure of the FJP tool are controlled by the Zeeko 7 axis CNC (Computer Numerical Control) machine tool controller.

millimeter and it works with a wide range of materials. It can also remove machining marks from prior processes without introducing another tool signature and there is no issue with tool wear."

In the context of optical components, however, there was one significant problem. Despite research by a number of parties, the end result using FJP was always a surface with quite significant waveforms. "A small amount of waviness is generally acceptable; however, certain mid- and high-spatial frequencies can cause light scattering, optical deformation or even diffraction," comments Beaucamp. "Unfor-

tunately surfaces polished by FJP generally featured more than 10 nm Ra of such waviness — far too much." Ra (Roughness Average) is the arithmetic mean of surface measurement maps.

Although this problem had been known since the late 1990s, Dr. Beaucamp was determined to find a way through. In 2010 Zeeko established a research centre at Chubu University, Japan, where they installed a CNC machine equipped with FJP technology (Figure 2).

With some initial support from Kesco Engineering in Tokyo, Dr. Beaucamp and the university team began to develop a computational fluid dynamics (CFD) model to investigate a number of the characteristics with FJP. In particular, they wanted to simulate the interface between fluid and air and trace the trajectories of individual abrasive particles. They then intended to compare the results achieved through modeling in COMSOL

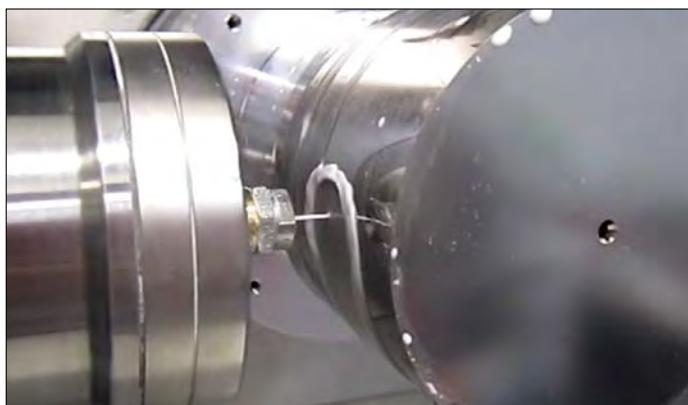

Figure 1. Fluid jet polishing of an aspheric die for thin X-Ray mirror replication. See the video at www.comsol.com/video/337/.



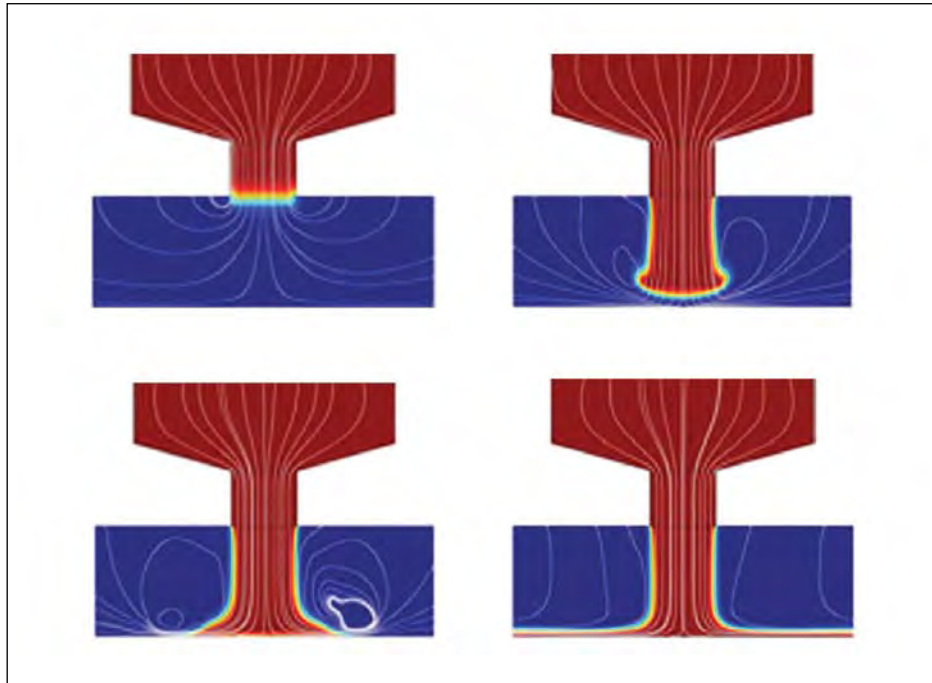

Figure 3. Snapshots of simulation: slurry (red), air (blue), and streamlines (white).

Multiphysics with actual machine performance. “Our aim was to get as close to 1 nm Ra as possible.”

Multiphase Modeling

“In FJP the jet forms a little spot that moves on the surface,” explains Dr. Beaucamp. “The spot follows a very tight raster path covering the optical area. The pumping system influences the jet pressure during this motion and it is the

combination of pumping and tracking that results in waviness. In terms of setting boundary conditions, the main thing was to understand resonant frequencies within the impinging flow from the nozzle, and how changing those frequencies would affect machining.”

The first stage was to model the fluid in a time-dependent state, flowing from the nozzle, impacting the surface and then flowing away. The simulation used the

k- ω turbulence model together with level set and phase field methods to model the fluid-air interface, and produced a series of chronological snapshots (Figure 3).

Further, the team did not want to assume that the particles within the slurry were ‘entrained’ or followed the fluid streamlines, so actual particle trajectories were also simulated (Figure 4). To do this, Dr. Beaucamp used the Particle Tracing Module, with Newtonian formulation to consider forces on the particles, like drag. The model showed a boundary layer that could only be penetrated by particles greater than 100 nm in size. Yet, it also indicated that the removal mode must be ductile (i.e., elastic) as particle energy was quickly dissipated over very small areas of the surface. This was also seen experimentally as no evidence of permanent damage, such as scratching or scouring, was evident.

Being confident with the model, Dr. Beaucamp could start using it to optimize the waviness that is primarily due to pressure instability in the slurry delivery system. Here, the nozzle was originally comprised of a high-pressure diaphragm pump and pulsation dampener. This resulted in progressive pressure drift (Figure 5, blue curve) so in order to improve inlet pressure stability, the team added a low-pressure feed-in pump to the system and connected a pressure gauge to the inverter powering the pump. This estab-

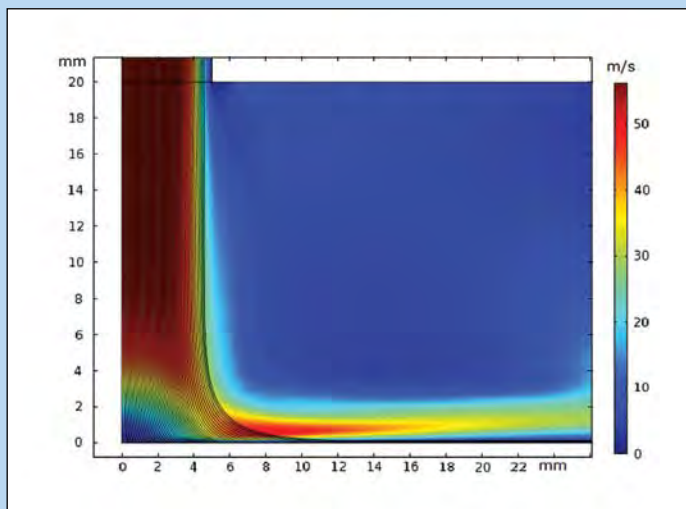

Figure 4. Particle tracing (black) and fluid velocity in m/s (color scale). The figure shows where the boundary layer (dark blue in color) is.

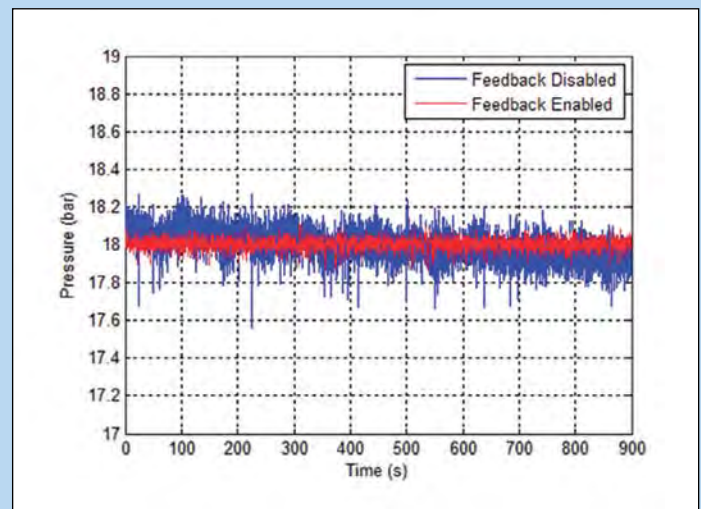

Figure 5. Pressure stability with (red curve) and without (blue curve) a feedback loop. Use of the feedback loop basically nullifies pressure drift.



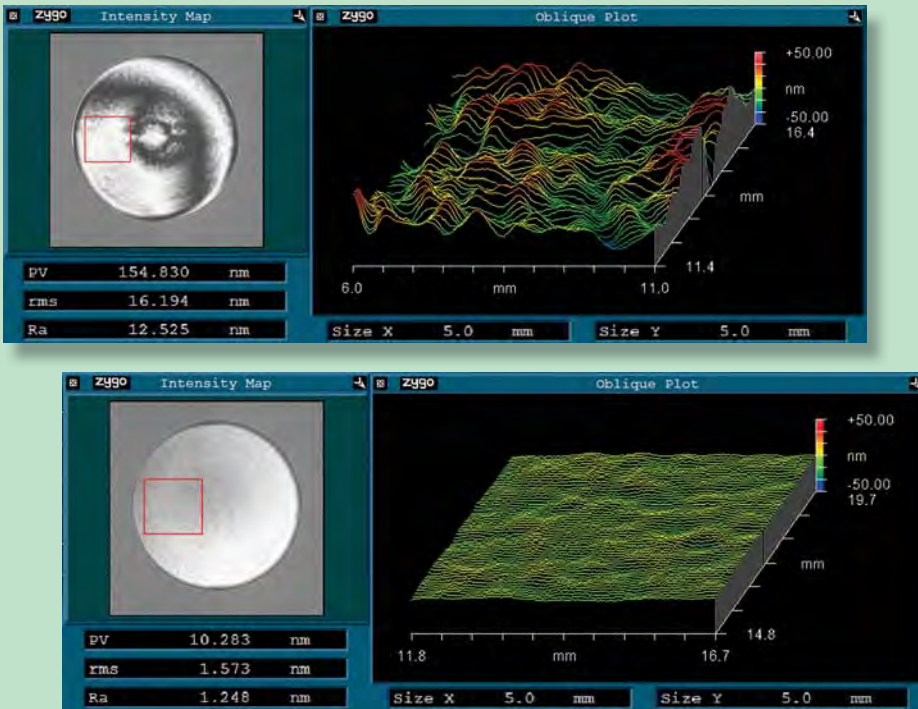

Figure 6. Surface roughness on 5×5 mm area of BK7 glass: (top) before optimization and (bottom) after optimization. The optimized operation reduced Ra from 12.5 nm to 1.2 nm, while the fringe map (left) clearly indicates the eradication of the waviness.



Figure 7. The new integrated system, which has a footprint less than a quarter of the size of the laboratory machines used for research.

lished a feedback control loop that improved overall pressure stability and corrected the average pressure drift (Figure 5, red curve).

From the results given in Figure 5, Dr. Beaucamp could predict the underlying pattern of pressure variations, imposed by the pump, through using Fourier transform analysis. Here, they could characterize the slurry system in different states and include these pres-

ning conditions dependent on the piece being machined, and the material it is made from.

From the Model to Mechanical Set Up

Once Dr. Beaucamp's team had reached a set of operating conditions the model described as being optimal, they then carried out experimental comparisons to gain confidence in their method.

a large amount of waviness over a 5×5 mm area (12.5 nm Ra) whereas this was greatly improved in the optimized system (1.2 nmRa)," he reports.

From One Day to Ten Minutes

Once Dr. Beaucamp and his team had the results they were seeking they lost no time turning them into an industrial application (Figure 7). Zeeko developed a production version of the research equipment and began selling it in Japan.

A number of major Japanese and Korean manufacturing companies are now using Zeeko technology for finishing optical molds. "A hand process that could take more than one day is now accomplished in ten minutes," explains Dr. Beaucamp. "This is giving our customers a huge advantage, enabling them to make better products and cut production costs. Until this breakthrough they were relying on very experienced optical workers to polish by hand; they simply could not get a machine to do this." ■

"A hand process that could take more than one day is now accomplished in ten minutes."

sure patterns in the COMSOL model. The model was then used to compute optimal conditions for the slurry delivery system using various nozzle sizes, stand-off distance and slurry types. Parametric sweeps were run and variations in the removal footprint extracted and analyzed. By examining trends in these variations as well as other results within the model, Dr. Beaucamp could recommend a number of optimal run-

They did this by polishing optical grade fused silica glass windows under both their original and then the optimized slurry delivery system conditions. The surface roughness was measured with an optical profiler and white light interferometer. Using software from Zygo Corporation, plots of the roughness and its intensity were given, along with the Ra value (Figure 6). "As we had anticipated, the non-optimized system showed

RESEARCH PAPER

www.comsol.com/papers/12495/





Modeling of Laminar Flow Static Mixers

Accurate CFD modeling is being used by Veryst Engineering and Nordson EFD for optimizing static mixers.

BY NAGI ELABBASI, XIAOHU LIU, AND STUART BROWN OF OF VERYST ENGINEERING LLC
 MIKE VIDAL AND MATTHEW PAPPALARDO OF NORDSON EFD

Static mixing of laminar viscous fluids has a wide range of industrial applications, especially in the pharmaceutical, biomedical, consumer product, and petrochemical industries. Yet, they are also quite difficult to model using traditional CFD methods. Veryst Engineering collaborated with Nordson EFD to find the best way to model these devices, and improve and optimize them.

Static mixers are inexpensive, accurate and can handle a wide range of fluids and mixing proportions. In many cases, the fluids to be blended are very viscous, and as molecular diffusion in laminar fluid mixing is very small, the fluids have to be mechanically mixed. This is in sharp contrast to turbulent mixing, or mixing of gases that involve significantly higher diffusion. The laminar fluid mixers analyzed in this study involve multiple elements that divide and recombine the flow, elements that invert the flow to move fluid away from the external boundary layer, and helical elements that stretch and fold the flow. A good mixing quality is obtained when the outlet of the static mixer has no concentrated volumes of either mixed materials and is overall uniform. Figure 1 shows disposable static mixers from Nordson



Figure 1. Disposable static mixers. (Photo courtesy of Nordson EFD, LLC)

EFD used to mix adhesives for construction, industrial and automotive bonding and repair applications.

Accurate CFD modeling is valuable for understanding and optimizing static mixers. However, two-phase CFD modeling by itself cannot be used due to numerical diffusion, a computational artifact that does not reflect the actual mixing process.

This diffusion can be reduced with finer mesh, less stabilization, and other numerical techniques. However, numerical diffusion always dominates over the very low molecular diffusion present in static laminar fluid mixing.

CFD, Particle Tracing, and Mixing Quality

Veryst Engineering, in collaboration with Nordson EFD, developed a new modeling tool for simulating laminar static mixers. We use COMSOL Multiphysics to perform a CFD analysis of the overall mixer performance, and predict the overall flow pattern and pressure drop (Figure 2). We then use both streamline and massless particle tracing data, in separate analyses, to follow the path of fluid particles with no numerical diffusion. Figure 3 shows velocity contours at different sections of a Nordson EFD mixer, and Figure 4 shows the particle tracing at an intermediate time. Figure 4 also shows two Poincaré sections, which indicate the locations where particles cross a specific plane in the mixer. Validation of these models involved mesh convergence studies for the CFD solution, and optimal time stepping and particle density

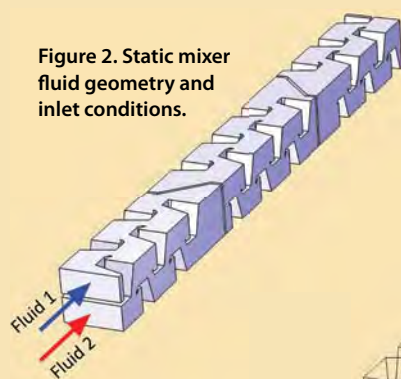

Figure 2. Static mixer fluid geometry and inlet conditions.

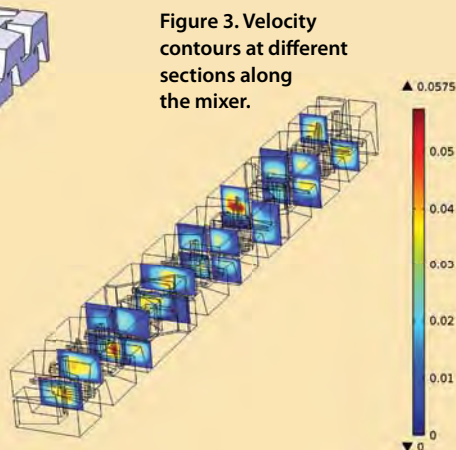

Figure 3. Velocity contours at different sections along the mixer.

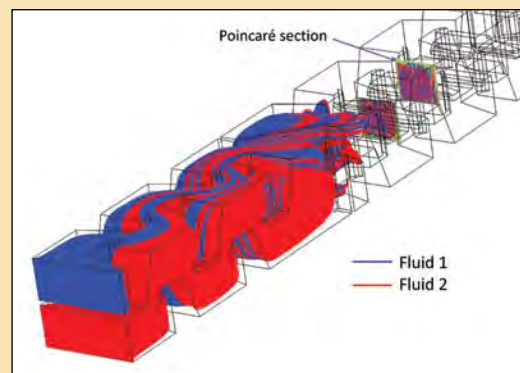

Figure 4. Particle tracing results at an intermediate time, together with a Poincaré section where good mixing is starting to occur.



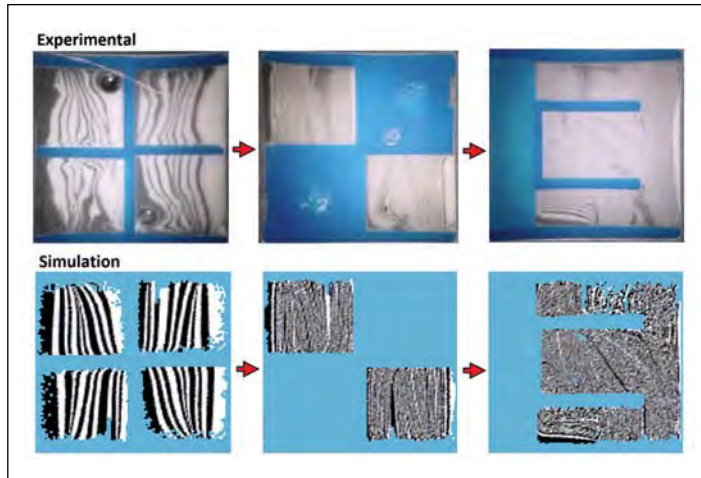

Figure 5. Comparison between experimental data and numerical mixing predictions at three sections along the first half of the mixer.

for the streamlines and particle tracing. At this stage, we recognized that the number of streamlines required to resolve the very thin streaks in the mixer was very large. We also found that using particle tracing in the Particle Tracing Module required significantly less computational time.

The streamline and particle tracing data is exported from COMSOL and used in a newly developed proprietary algorithm that computes two measures of mixing quality. The first is a coefficient of variation (CoV), which is a quantity that has a value of one for no mixing, and zero for perfect mixing. Here, “perfect mixing” is relative to a user-controlled length scale. The second metric is a series of cross-sectional mixer images similar to the Poincaré sections (Figure 4). These images help identify local streaks of one material that may not be clearly shown in an overall CoV analysis. The mixing images can also be stacked together to create an animation that facilitates mixing visualization.

Reliable Simulation Results

To validate this modeling tool, we compared the results to targeted mixing experiments performed by Nordson EFD involving the mixing of two epoxy materials — a black and a white compound. These materials solidify when mixed. After solidification, the mixer was sliced into about forty sections to visually assess the mixing quality.

are the mixing elements. The black and white epoxies had slightly different entry angles in the experiment and in the simulation, due to the imperfect segregation of the two epoxies prior to reaching the mixing elements. This affects the distribution of black/white epoxy at different sections along the mixer. However, fluid mixer entry angles are known to have an insignificant effect on mixing quality. We find that there is excellent overall agreement between experimental and simulation results in terms of identifying unmixed regions and fluid streaks.

four states, depending on the streamlines, or particles, that intersect that cell. These values are: (i) material 1, marked as black; (ii) material 2, marked as white; (iii) well-mixed, marked as gray; and (iv) no data. Cells receive no data when they are in dead-flow zones, or recirculation zones. To reduce the amount of no-data zones, we generate particle tracing paths starting at different sections in the mixer (not just at the beginning).

Figure 5 shows a comparison between the experimental data and the numerical predictions for another Nordson EFD mixer at three different cross-sections along the first half of the mixer. The blue colored regions in the experimental data

“We find that there is excellent overall agreement between experimental and simulation results...”

Veryst also used streamline and particle tracing data to generate cross-sectional images comparable to the experimental results. The mixer cross-section is divided into equal sized cells that can take

are the mixing elements. The black and white epoxies had slightly different entry angles in the experiment and in the simulation, due to the imperfect segregation of the two epoxies prior to reaching the mixing elements. This affects the distribution of black/white epoxy at different sections along the mixer. However, fluid mixer entry angles are known to have an insignificant effect on mixing quality. We find that there is excellent overall agreement between experimental and simulation results in terms of identifying unmixed regions and fluid streaks.

Optimized Mixer Designs

The CFD simulation, particle tracing, and data processing algorithm provide a valuable tool for understanding the flow patterns inside the mixer beyond what is possible by pure experimentation. This is helping Nordson EFD optimize some of their mixer designs. Veryst Engineering and Nordson EFD are still working together on further improving the developed mixing tools, and expanding their application to other mixer geometries, mixing of significantly different fluids, and non-Newtonian fluid mixing. ■

About the Companies

Veryst Engineering, LLC

Veryst Engineering, LLC provides premium engineering services and consulting at the interface of technology and manufacturing. The Veryst Mission is “Engineering Through the Fundamentals” employing grounded knowledge of mechanics, physics, manufacturing, and computational methods to produce practical, useful results. Our consultants’ backgrounds encompass teaching, extensive publications, industrial experience, and research. Veryst Engineering is a COMSOL Certified Consultant.

Nordson EFD

Nordson EFD is a leading manufacturer of precision dispensing systems that apply accurate, consistent amounts of the adhesives, sealants, lubricants and other assembly fluids used in virtually every manufacturing process. In addition to static mixers, Nordson EFD’s 2K Product Line includes packaging systems and metering-mixing valves for reactive two-component adhesives and sealants, such as epoxies, urethanes, silicones and acrylics. Nordson EFD products are available through a worldwide network operating in more than 30 countries.



solid mechanics / fluid flow
material kinetics / nonlinear materials
polymer modeling / acoustics
mass transfer / heat transfer

veryst engineering
consulting for a multiphysics world



® Experienced COMSOL Multiphysics Consulting team using engineering fundamentals and modeling to solve complex industrial problems:
Biomedical / Consumer Products / Energy / Manufacturing / Transportation

Veryst Engineering, LLC / contact@veryst.com / 781-433-0433





Submarines: Corrosion Protection or Enemy Detection?

Numerical analysis of the electrochemical interplay between a coated hull, propeller induced modulations and a submarine's underwater electric potential signature is being used to optimize safety in stealth mode.

BY JENNIFER HAND

The ability to move discreetly below the surface of the sea is a fundamental requirement for a submarine. The alternative is detection or, in a hostile situation, a high risk of actuating seabed mines.

Much research has therefore focused on the signals that vessels inevitably emit when they are navigating underwater. These include acoustic and magnetic 'signatures', and most state-of-the-art

detection devices are based on extremely sophisticated magnetic and acoustic sensors. In response, acoustic sources on submarines are avoided or silenced with great effort, and the strategic use of non-magnetic material, such as the nickel alloyed austenitic stainless steel, can reduce their magnetic signatures.

In contrast, the underwater electric potential (UEP) signature created by corrosion and corrosion protection systems has

so far received less attention. Yet, mines with UEP sensors are already available and there is growing recognition that mines of the future will increasingly exploit these electric fields. Germany's Technical Center for Ships and Naval Weapons (WTD 71) has therefore commissioned the Laboratory for General and Theoretical Electrical Engineering (ATE) at the University of Duisburg-Essen to undertake research into UEP signatures from submarines.

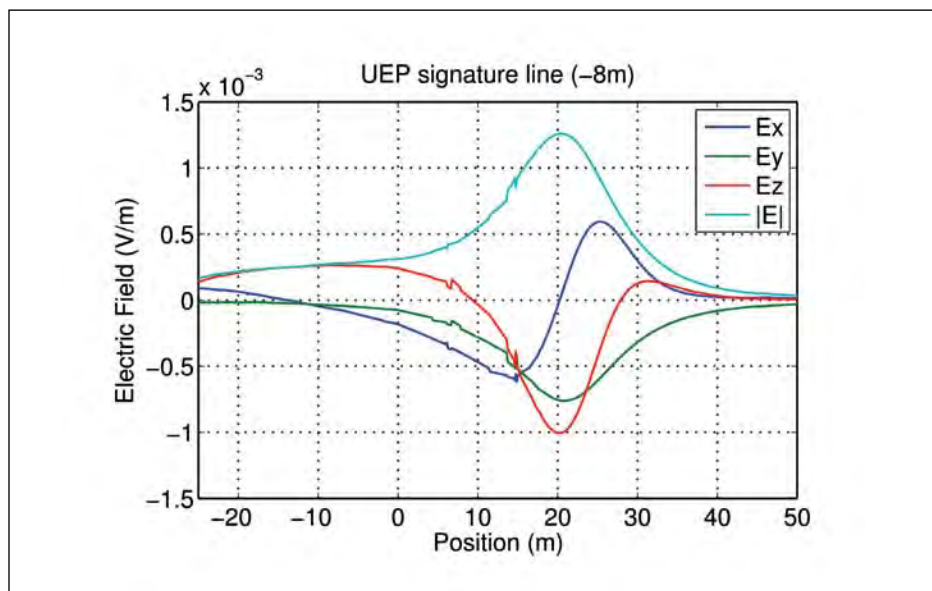

Figure 1. Axial trace of the near-field (8m below the keel) UEP signature of a simplified submarine model, simulated in COMSOL Multiphysics.

Distribution of the Electric Potential and Current Density

As a member of the university team, Dipl.-Ing. David Schaefer explains how the research began: "The UEP signature stems from the fact that the corrosion process and impressed current cathodic protection (ICCP) systems, designed to prevent the corrosion of metal components, create a current density distribution with a related electric field around the vessel. The electric field varies according to environmental conditions, such as the conductivity of the seawater, and the use of different metals throughout the submarine's design." A vessel's UEP signature is usually defined by the value of the electric field on a plane surface or along a line (Figure 1).

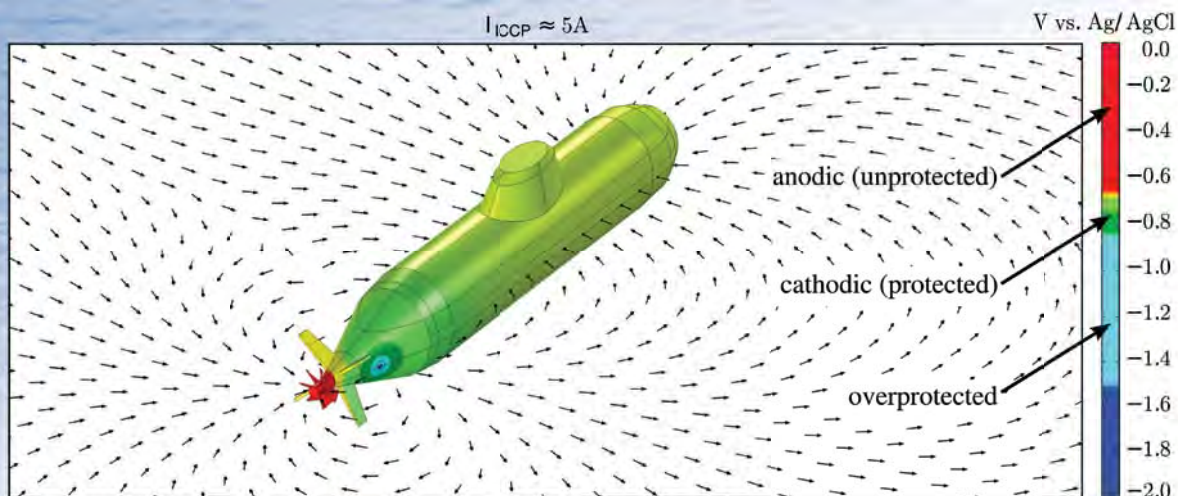

Figure 2. Potential distribution for when cathodic protection is being imposed. The arrows represent the direction of the electric field. Under normal operating conditions the ICCP current would be a little bit higher (about $I_{ICCP}=8A$) to ensure a cathodic state (green color) all over the hull. The colormap is based on the German naval directive VG 81259.

The team took into account the electrochemical reactions that result from corrosion at the submarine hull. These were simulated using nonlinear polarization curves, which describe the amount of current density that occurs at a certain electric potential in the electrolyte.

The team had to assign the polarization curves as non-bijective functions because this allowed them to consider the electrochemical passivity. Stainless steel, which is used in the hulls of Ger-

man submarines, normally protects itself against corrosion by building up a dense layer of oxides on its surface. In the polarization curves this so-called “passivity” can be noticed by a decrease of current density for anodic potentials. However, under unfortunate conditions, e.g. high oxygen gradients in gaps, the protective layer cannot develop and the material corrodes rapidly. Thus the word “stainless” is somewhat misleading, because the materials are in fact not completely invulnerable against corrosion, and hence have to be protected. For this reason it was not possible to describe the electrode kinetics by common approximations such as the Butler-Volmer or Tafel equations.

In the first model (Figure 2) the team simulated the electric potential distribution on the hull of a submarine, which indicates whether or not the material is protected against corrosion. “The ICCP system forces the surface of the hull into a cathodic operating point, which is visualized by the green color in Figure 2,” comments Schaefer.

Calculating the Electric Signatures

Having established the potential distribution on the hull for different ICCP setups, the next step was to determine the related UEP signature. “Once we simulated the potential

distribution with COMSOL, we were able to directly extract the associated electric field in the water and receive the corresponding UEP signature,” said Schaefer.

“Once we simulated the potential distribution with COMSOL, we were able to directly extract the associated electric field in the water and receive the corresponding UEP signature.”

One challenge was the moving boundary problem created by the rotating propeller blades. The angle of propeller rotation was increased successively, as a parametric sweep, and the maximum values of the electric field in different depths below the submarine keel were extracted and visualized. Figure 3 clearly depicts how the high fields at the tips of the propeller blades modulate the electric near-field, which decays rapidly the further away from the propeller you measure the field.

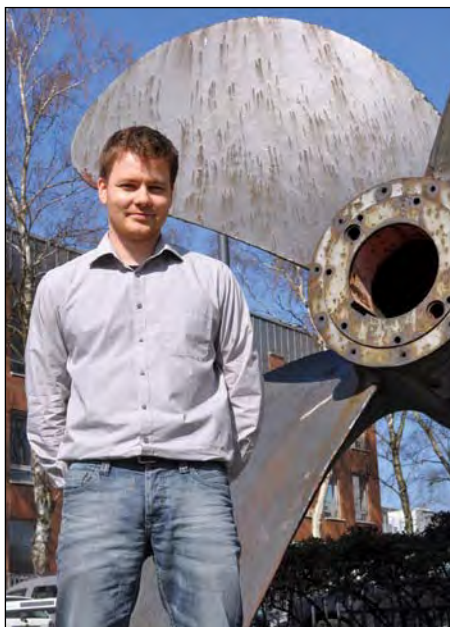

Dipl. Ing. David Schaefer in front of a corroded ship's propeller.



DIRICHLET BOUNDARY CONDITIONS:

NON-LINEAR POLARIZATION CURVES:

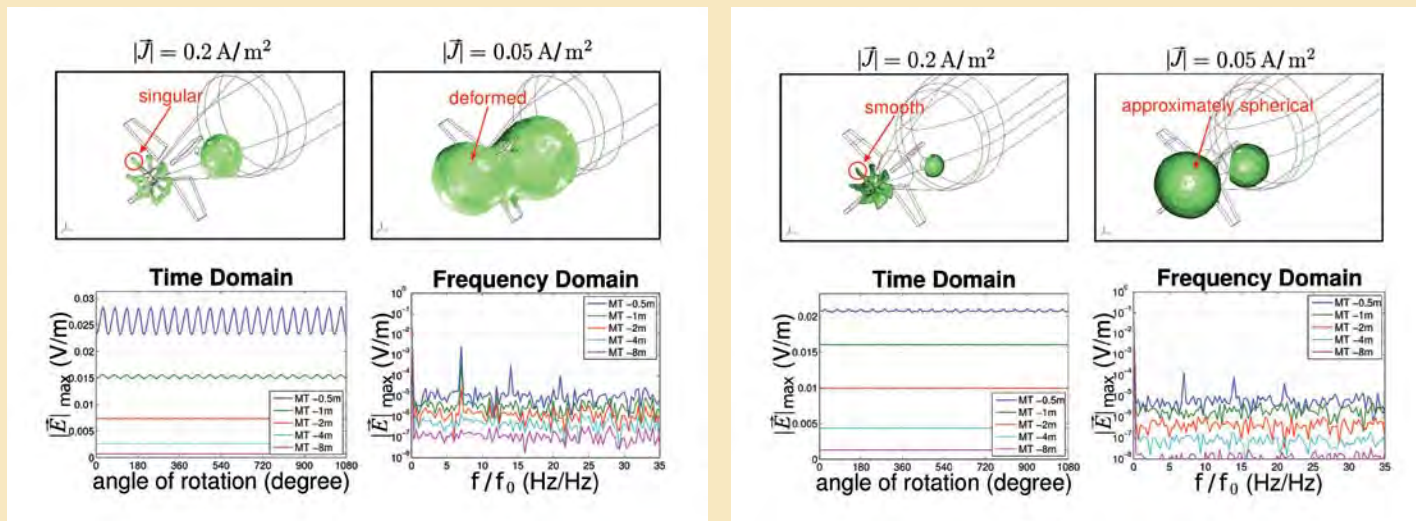

Figure 3. Simulated near-field modulations during propeller revolution. The simplified assumption of Dirichlet boundary conditions (left) leads to significantly more modulation than the consideration of the electrochemical reactions at the boundaries using non-linear polarization curves (right).

To demonstrate how electrochemical reactions affect the near-field modulation in principle, the team also performed simulations using Dirichlet boundary conditions (Figure 3, left)

fer, “The smoothing effect is a result of the ‘polarization resistance’ at the interface between the electron conductor (metal) and ion conductor (sea water). The polarization resistance counter-

great ICCP currents, especially when the hull is forced into overprotection, which means that it is more cathodic than necessary. It is therefore an obvious guess that the UEP signature could be less intense for a switched-off ICCP system.

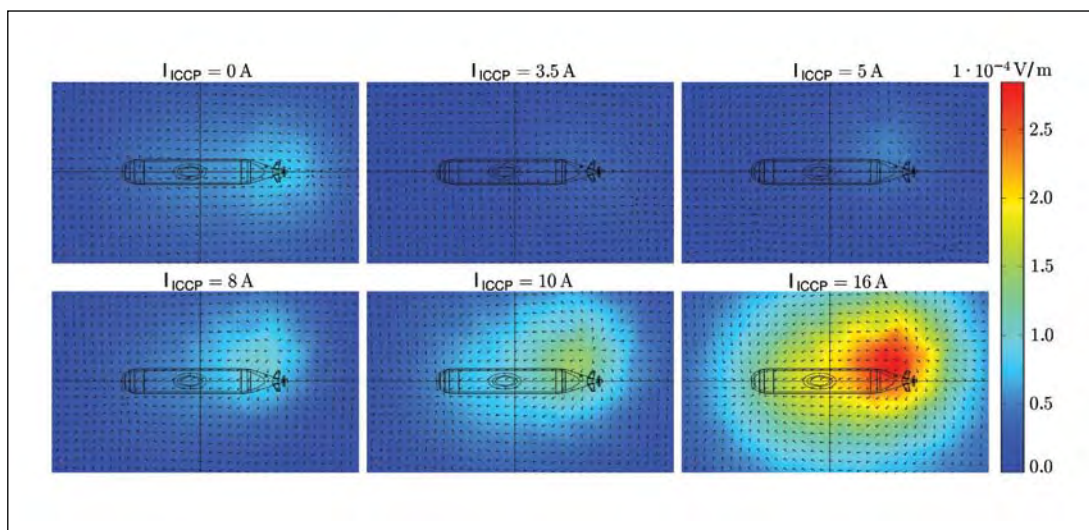

Figure 4. Signature planes of the electric field in a depth of 20m (66ft) below the keel, for different currents impressed by the ICCP system. A signature is evident when ICCP is switched off (top left), which can be optimized at 3.5 A (top middle). Overprotection, on the other hand, leads to a large UEP signature ($I_{ICCP}=16A$, bottom right).

Figure 4 shows that surprisingly neither the switched off mode ($I_{ICCP}=0A$) nor the normal operating conditions ($I_{ICCP}=8A$) produce an optimal UEP signature. Instead, the smallest field strength appears to be in between these two ICCP setups ($I_{ICCP}=3.5A$). The figure also affirms the assumption that overprotection leads to a critically high signature ($I_{ICCP}=16A$).

where electrochemistry is completely disregarded. A comparison of the resulting isosurface plots in Figure 3 illustrates how the electrochemical reactions reduce the modulation by smoothing the field peaks at sharp angles and edges. According to Schae-

fers, “There is clearly a balance to be achieved between corrosion protection and UEP signature. It is vital that we understand the consequences of changing ICCP settings, particularly in stealth situations,” concludes Schaefer. “Yet, we have also shown that it is possible to optimize ICCP to reduce the UEP signature.” ■

Optimal Settings for the ICCP

Practical experience indicates that the signature becomes more pronounced for

protection and UEP signature. It is vital that we understand the consequences of changing ICCP settings, particularly in stealth situations,” concludes Schaefer. “Yet, we have also shown that it is possible to optimize ICCP to reduce the UEP signature.” ■

Multiphysics Simulations Enable Development of Fast, Cheap MEMS-Based Bacteria Detector

Winner of 2011 Create the Future Design Contest aims at reducing food-borne infections.

BY GARY DAGASTINE, CONTRIBUTING EDITOR, TECH BRIEFS MEDIA GROUP

Food-borne *E. coli* and salmonella bacteria cause thousands of infections annually, leading to human and animal deaths and to significant economic losses. The deadliest *E. coli* outbreak in recorded history, centered in Germany last summer, caused at least 50 deaths and more than 4,000 reported cases of poisoning in more than a dozen countries, with economic damages in the hundreds of millions of Euros.

Such outcomes could be avoided with better and less expensive bacteria detection technologies. The widely used plate count method takes 24-48 hours because bacteria need that long to grow into detectable colonies. That's too long for most food industry applications because food needs to be delivered and sold fresh.

Newer alternatives also fall short. Polymerase chain reaction (PCR) testing takes only three hours but costs about \$50 per test — too expensive for routine use. Labeled detection and fluorescent imaging technology, meanwhile, can detect a single bacterium but requires specialized laboratories and procedures, and is even more expensive.

Fortunately, a promising MEMS (microelectromechanical system)-based

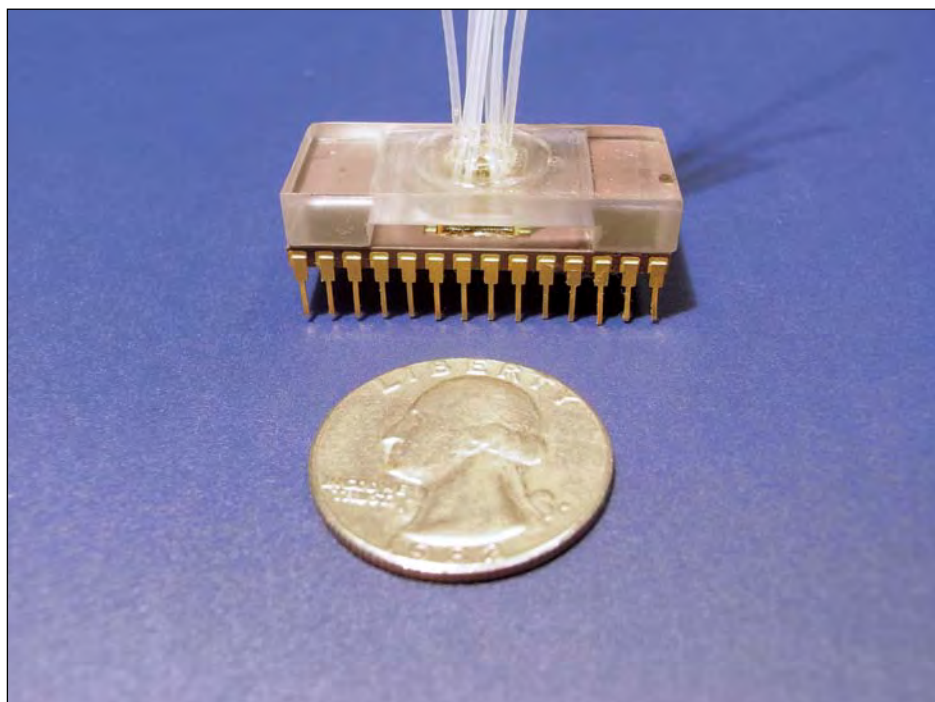

Figure 1. Prototype of the α Screen bacteria-detection system near a U.S. quarter coin for scale.

and accurate bacteria detection with a coin-sized, cheap, easy-to-use and disposable device (Figure 1).

α Screen was the winning design of the 2011 edition of the popular Create the Future Design Contest. Launched in 2002 by the publishers of *NASA Tech Briefs* maga-

α Screen is being developed by Monika Weber, PhD. Candidate in Electrical Engineering at Yale University, and a team she is leading in Professor Mark Reed's nanotechnology group there. As Grand Prize Winner, Weber received a \$20,000 cash prize, which she donated to Yale to help fund prototype development.

" α Screen technology has great potential to reduce infectious disease in developing countries where people lack resources and can't afford healthcare," Weber said. "About four percent of all deaths worldwide are from diarrhea, mostly caused by bacteria. As a fast, low-cost technology, α Screen will help solve a critical world problem. The ultimate goal is the detection of hundreds of different bacterial diseases."

How It Works

The advent of nanoscale field-effect transistors (FETs) has led to new ways

" α Screen technology has great potential to reduce infectious disease in developing countries where people lack resources and can't afford healthcare."

solution developed with the aid of multiphysics simulation software is on the horizon. Now undergoing prototype testing, α Screen technology combines a novel way to separate bacteria from blood, and a nanoscale sensor to detect the bacteria. It holds the promise of fast

zine to help stimulate and reward engineering innovation, the annual event has attracted more than 7,000 product design ideas from engineers, entrepreneurs, and students worldwide. Principal sponsors of the 2011 contest were COMSOL, PTC, and Tech Briefs Media Group.



The Yale University design team that won the 2011 Create the Future Design Contest consisted of (from left) team leader Monika Weber, Christopher Yerino, Hazael Montanaro, Kane Siu Lung Lo, and Professor Mark Reed. The prototyping team consists of Weber and (not pictured) Kara Brower, Brian Goldstein, and Phillip McCown, with Professors Mark Reed and Tarek Fahmy as advisors.



to detect proteins and other biological markers in fluids. In theory, systems can be engineered so that a specific target's proximity alters a FET's gate potential, thereby modulating its drain current and signaling the target's presence.

But in practice, acceptable performance is difficult to achieve because targets are often carried in high-ionic fluids like blood, and the tiny FETs have ultra-low operating currents easily overwhelmed by ionic charge.

"We are developing a way to separate bacteria from blood components, such as red and white blood cells, using a

non-uniform electric field. We use asymmetrically placed electrodes to generate a specific frequency within a microchamber to create an electric dipole moment. Then, we use dielectrophoretic force to move the bacteria into microchannels and to transport them along for the next step, which is to submerge and concentrate the bacteria in a low-ionic solution," Weber said.

"Next, in the detection part of the device, we have functionalized the FET sensors with bacteria-specific antibodies for bacteria selectivity and specificity, so they will be able to detect any targets that may

be present. These transistors use nanowires as active channels and are built using standard, low-cost semiconductor-industry CMOS fabrication technology."

The entire bacteria-separation portion of α Screen was modeled from late 2010 to early 2011 using COMSOL Multiphysics (Figure 2). Subcomponents for the detection portion, meanwhile, have been prototyped and are now undergoing testing. The device will be the size of a coin, and the projected cost per test will be as low as \$1.

"Without COMSOL, I am sure we wouldn't have ended up with such a good design, and it also probably would have taken years to test and optimize rather than weeks," Weber explained. "We simulated all of the physics involved along the entire path from sample injection to detection, encompassing all forces, all trajectories, everything," she said.

"Now that we have gotten access to the most recent version of COMSOL, I am looking forward to the LiveLink™ for CAD interoperability features. Professor Reed's laboratory has extended technical computing resources, and these options will make our lives much easier by integrating COMSOL more tightly within that environment," said Weber.

Commercialization Plans

"We have decided to commercialize this technology, and as a first step, we have applied for a grant from funding agencies to target the development of this device for infectious disease control in developing countries," Weber said.

"We believe it has tremendous potential to revolutionize diagnostics in the developing world, and we are committed to making that happen." ■

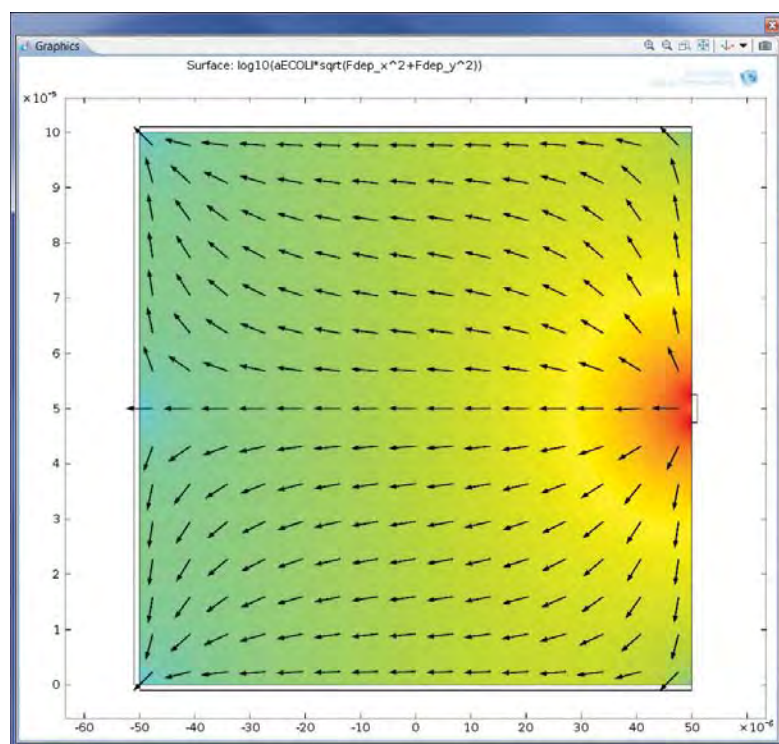

Figure 2. COMSOL particle-tracking simulation of dielectrophoretic force on *E. coli* bacterium inside a microchannel.





Rick Nopper works in the DuPont Engineering Department in Wilmington, Delaware. His modeling activities go back to his PhD project (Boston College, 1978), a numerical model of the global ionospheric electric field. At Conoco Petroleum Exploration Research he modeled geologic deformation and heat flow. In 1989, he came to DuPont as in-house

consultant and has developed models in many areas: microelectronic devices, superconducting magnets, filter/barrier materials, reinforced composites, groundwater treatment, atmospheric chemistry and transport, and particle aggregation. In his spare time, he likes to play jazz keyboard.

GUEST EDITORIAL

Mathematical Modeling: An Industrial Perspective

At DuPont, modeling is viewed as an enabling technology supporting our wide diversity of science and technology areas. Since the advent of supercomputers, computational scientists have applied their craft as a “third branch of science,” complementing experiment and traditional theory.

It is convenient to divide modeling into two classes: empirical and fundamental. Empirical modeling is data-driven, dominated by data analysis and statistics. On the other hand, fundamental modeling is driven by a set of governing equations; the “theory.” Although theory is guided by empirical evidence, other considerations enter, too: conservation laws, symmetries, gauge invariance, etc.

The dual nature of modeling fits its progression of application. Initially, empirical models help organize and interpret data, providing useful quantitative relationships. Fundamental models then bring in the applicable theory and codify understanding, both qualitatively and quantitatively, facilitating further development and efficient management of knowledge. Finally, validated fundamental models enable design, optimization, and control of product and/or process. Design and optimization tend to be the main uses to which we put finite-element models.

To accomplish all this requires a hardware infrastructure, which, at DuPont, supports platforms from laptop machines

to high-performance compute clusters and clouds, and provides administrative computing services to users networked around the globe.

The DuPont technical computing organization provides a hierarchy of software tools. This begins with utilities and “low-level” programming languages. Next are numerical libraries and tools for general mathematical analysis (MATLAB®, etc.). Heavily used are the engineering analysis packages (finite-element such as COMSOL Multiphysics® and process flow-sheet models) and visualization tools. A good collection of statistical applications supports empirical modeling. Also important are tools for managing databases and large datasets. Finally, we license or have developed special-purpose codes for quantum chemistry, molecular dynamics, particle processes, bioinformatics, etc.

Even with all this firepower, modeling still faces formidable technical challenges. Most problems are ill-defined at the outset — modeling can help here. Many problems are inherently multiphysics; fortunately, we now have tools that couple diverse and complex phenomena without requiring a major development effort. Many problems are disordered in some sense (usually in geometry) and span multiple scale sizes. There is no general method for dealing with these, so the approach must be customized.

In an industrial setting, modelers often appear in a consulting role with other scientists and engineers on a project. It is important to apply modeling in a way that maximizes its impact — otherwise someone will say it is too expensive. Introduce modeling early on when it can really make a difference. Understand what you are modeling and why. Do not oversell the capabilities of models to your colleagues. Understand their experimental methods and data. While getting good input data can be a difficult task, models can suggest what is needed. Perform a scale analysis of the problem to identify what is important and what is not. Draw things to proper (relative) scale. Do hand calculations of simplified cases; these provide insight and good test cases for numerical models.

Probe the sensitivities of model results to variations in parameters. Trends in the model results are often useful even if absolute numbers are unattainable or if adjustable parameters are required in the model. Some models incorporate parameter optimization tools for this purpose. Tie your model results to experiments. Finally, don't just throw your model results over the wall. Insist on interpreting them in concert with your colleagues. Thus do you build technical expertise in your organization. ■

RESEARCH PAPER

www.comsol.com/papers/10251/

